







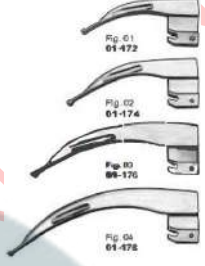






















GENERAL SURGERY INSTRUMENTS CATALOG (HMI-GS)

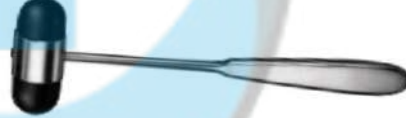
DIAGNOSTIC / Preparation instruments









Sr No.	Page No.	Product Code	Description	Images
1	1	HMI-GS-001	DIAGNOSTIC SET (ENT COMPLETE) Consisting of Battery Handle (without Battery) 3 Ear Specula, 1 Nasel Specula, 2 Laryngeal Mirrors with Holder 1 Tongue Depressor Holder, 1 Bulb	
2	2	HMI-GS-002	OTOSCOPE SET Consisting of Battery Handle (without Battery) 3 Ear Specula, 1 Nasel Specula,	
3	01	HMI-GS-003	MAGILL 17 cm, 6 3/4"	
4	01	HMI-GS-004	MAGILL 20 cm, 8"	
5	01	HMI-GS-005	MAGILL 25 cm, 10"	
6	02	HMI-GS-006	GUEDEL-NEGUS Battery handle only with for Laryngoscope blades No. 1 to 4 complete, in case.	









7	02	HMI-GS-007	Fig. 01	
8	02	HMI-GS-008	Fig. 02	
9	02	HMI-GS-009	Fig. 03	
10	02	HMI-GS-010	Fig. 04	
11	02	HMI-GS-011	MCINTOSH Fiber Optic Laryngoscope set with 4 blades (fig. 01 to 04) in wooden/ rexin box.	
12	02	HMI-GS-012	Fig. 01	
13	02	HMI-GS-013	Fig. 02	
14	02	HMI-GS-014	Fig. 03	
15	02	HMI-GS-015	Fig. 04	
16	02	HMI-GS-016	BATTERY HANDLE without battery Use with battery - Size C (01-162 – 01-168 01-172 – 01-178)	
17	03	HMI-GS-017	FRANCKE Blood Lancets	
18	03	HMI-GS-018	FRANCKE Blood Lancets	
19	03	HMI-GS-019	BOWLES CHEST PIECES	
20	03	HMI-GS-020	FORD	






21	03	HMI-GS-021	LIGHT WEIGHT	
22	03	HMI-GS-022	SPRAGUE-BOWLES	
23	03	HMI-GS-023	BOWLES	
24	03	HMI-GS-024	FORD	
25	03	HMI-GS-025	BELL-END	
26	03	HMI-GS-026	SPARE RUBBER	
27	03	HMI-GS-027	DIAPHARM	
28	03	HMI-GS-028	SCHIMMELBUSCH ADULT	
29	03	HMI-GS-029	SCHIMMELBUSCH CHILD	






30	03	HMI-GS-030	YANKAUER ADULT	
31	03	HMI-GS-031	YANKAUER CHILD	
32	03	HMI-GS-032	CONNELL ADULT	
33	03	HMI-GS-033	CONNELL CHILD	
34	03	HMI-GS-034	HEAD FRAME (FOR LIHTWEIGHT)	
35	03	HMI-GS-035	HEAD FRAME (FOR BINURAL)	
36	03	HMI-GS-036	BOWLES	
37	03	HMI-GS-037	FORD	
38	03	HMI-GS-038	FORD-BOWLES	









39	03	HMI-GS-039	LIGHTWEIGHT	
40	03	HMI-GS-040	PINARD ALUMINIUM	
41	03	HMI-GS-041	PINARD WOODEN	
42	04	HMI-GS-042	NEURO-DUOFLEX 22 cm, 8 3/4"	
43	04	HMI-GS-043	DEJERINE 20 cm, 8"	
44	04	HMI-GS-044	DEJERINE 20 cm, 8"	
45	04	HMI-GS-045	TROEMNER 24.5 cm, 9 3/4" spare rubber 145 g	
46	04	HMI-GS-046	TROEMNER 24.5 cm, 9 3/4" spare rubber 175 g	






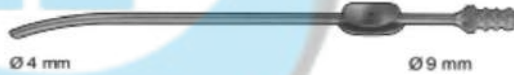


47	04	HMI-GS-047	TROEMNER 24.5 cm, 9 3/4" spare rubber 235 g	 <p>TROEMNER 01-390 145 g 01-392 175 g 01-394 235 g 24.5 cm, 9 3/4" spare rubber</p>
48	04	HMI-GS-048	TROEMNER-SIMPLEX 21 cm, 8 1/4"	
49	04	HMI-GS-049	BUCK 18.5 cm, 7 1/4"	
50	04	HMI-GS-050	BUCK HAMMER 18 cm, 7"	
51	04	HMI-GS-051	TAYLOR 18 cm, 7"	
52	04	HMI-GS-052	TAYLOR 20 cm, 8"	
53	04	HMI-GS-053	TAYLOR 18 cm, 7"	
54	04	HMI-GS-054	BABINSKY 22 cm, 8 3/4"	








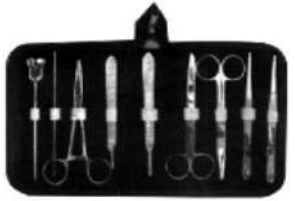
55	04	HMI-GS-055	BABINSKY 22 cm, 8 ¾"	
56	04	HMI-GS-056	RABINER 25.5 cm, 10" with needle & brush	
57	04	HMI-GS-057	BERLINER 20.0 cm, 8"	
58	04	HMI-GS-058	TRAUBE 16 cm, 6 ¼"	
59	04	HMI-GS-059	WARTENBERG 19 cm, 7 ½"	
60	05	HMI-GS-060	UNIVERSAL Set of 4 1.7 mm Ø, 3 mm Ø, 4.5 mm Ø, 6 mm Ø	
61	05	HMI-GS-061	UNIVERSAL Set of 3	
62	05	HMI-GS-062	ABDOMINAL 3.0 mm Ø	
63	05	HMI-GS-063	ABDOMINAL 3.5 mm Ø	
64	05	HMI-GS-064	ABDOMINAL 4.0 mm Ø	
65	05	HMI-GS-065	ABDOMINAL 3.5 mm Ø	









66	05	HMI-GS-066	ABDOMINAL 5.0 mm Ø	
67	05	HMI-GS-067	ABDOMINAL 5.5 mm Ø	
68	05	HMI-GS-068	ABDOMINAL 6.0 mm Ø	
69	05	HMI-GS-069	ABDOMINAL 3.0 mm Ø	
70	05	HMI-GS-070	ABDOMINAL 3.5 mm Ø	
71	05	HMI-GS-071	ABDOMINAL 4.0 mm Ø	
72	05	HMI-GS-072	ABDOMINAL 3.5 mm Ø	
73	05	HMI-GS-073	ABDOMINAL 5.0 mm Ø	
74	05	HMI-GS-074	ABDOMINAL 5.5 mm Ø	
75	05	HMI-GS-075	ABDOMINAL 6.0 mm Ø	
76	05	HMI-GS-076	ABDOMINAL 3.0 mm Ø	
77	05	HMI-GS-077	ABDOMINAL 3.5 mm Ø	
78	05	HMI-GS-078	ABDOMINAL 4.0 mm Ø	
79	05	HMI-GS-079	ABDOMINAL 3.5 mm Ø	
80	05	HMI-GS-080	ABDOMINAL 5.0 mm Ø	
81	05	HMI-GS-081	ABDOMINAL 5.5 mm Ø	
82	05	HMI-GS-082	ABDOMINAL 6.0 mm Ø	
83	05	HMI-GS-083	NELSON 25 Fg.	
84	05	HMI-GS-084	NELSON 25 Fg.	
85	05	HMI-GS-085	NELSON 25 Fg.	
86	05	HMI-GS-086	NELSON 25 Fg.	
87	05	HMI-GS-087	HYDROCELE 8Fg.	
88	05	HMI-GS-088	HYDROCELE 9Fg.	
89	05	HMI-GS-089	HYDROCELE 10Fg.	

90	05	HMI-GS-090	ACITES 16Fg.	
91	05	HMI-GS-091	ACITES 21Fg.	
92	05	HMI-GS-092	FLEURANT	
93	05	HMI-GS-093	FLEURANT	
94	05	HMI-GS-094	KRAUSE 5.5mm Ø	
95	05	HMI-GS-095	LICHTWITZ 1.75mm Ø	
96	05	HMI-GS-096	OCHSNER 10Fg.	
97	05	HMI-GS-097	OCHSNER 12Fg.	
98	05	HMI-GS-098	OCHSNER 14Fg.	
99	05	HMI-GS-099	OCHSNER 16Fg.	
100	05	HMI-GS-100	OCHSNER 18Fg.	
101	05	HMI-GS-101	OCHSNER 20Fg.	
102	06	HMI-GS-102	POOL 30 Fg.	 Ø 10 mm Charr. 30 Ø 8 - 10.5 mm









103	06	HMI-GS-103	POOL 30 Fg.	
104	06	HMI-GS-104	COOLEY 33.0 cm, 13"	
105	06	HMI-GS-105	COOLEY 35 cm, 13 3/4"	
106	06	HMI-GS-106	COOLEY 30.0 cm, 12"	
107	06	HMI-GS-107	COOLEY 31.0 cm, 12 1/4"	
108	06	HMI-GS-108	MILLIN'S SUCTION TUBE chromium-plated, with sliding "on & off" action.	
109	06	HMI-GS-109	YANKAUER	
110	06	HMI-GS-110	YANKAUER 28.5 cm, 11" with especially large central bore, 4.8 mm clam	














111	06	HMI-GS-111	YANKAUER 28.5 cm, 11" with central bore, 2.0 mm Diam.	
112	06	HMI-GS-112	DE-BAKEY 28.5 cm, 11" with central bore, 3.0 mm Diam. With lateral slots	
113	07	HMI-GS-113	COUPLAND Ø 1.5 mm	
114	07	HMI-GS-114	BYRD 1.5 mm	
115	07	HMI-GS-115	BYRD 2.5 mm	
116	07	HMI-GS-116	BYRD 3.5 mm	
117	07	HMI-GS-117	DE-BAKEY 16 cm, 5" with finger cut-off and stylet	
118	07	HMI-GS-118	19 cm, 7 1/4" cut-off	
119	07	HMI-GS-119	DE-BAKEY 27 cm, 10 3/4" with finger cut-off and stylet	
120	07	HMI-GS-120	Nasal suction tubes Ø 4.5 mm 17.5 cm, 7"	

121	07	HMI-GS-121	Nasal suction tubes Ø 5.5 mm 17.5 cm, 7"	
122	07	HMI-GS-122	LOPEZ-REINKE 23.5 cm, 9" tonsil dissector whit suction device	
123	07	HMI-GS-123	FERGUSSON Ø 4.0 mm 18 cm, 7" insulated, with finger cut-off and stylet, thumb piece 90° to curved, with Luer hub	
124	07	HMI-GS-124	FRAZIER Ø 3.0 mm 18 cm, 7" insulated, with finger cut-off and stylet, thumb piece 90° to curved, with Luer hub	
125	07	HMI-GS-125	FRAZIER Ø 5.0 mm 18 cm, 7" insulated, with finger cut-off and stylet, thumb piece 90° to curved, with Luer hub	
126	07	HMI-GS-126	18 cm, 7" Ø 5.0 mm diam., Tip 6.5 mm wice nasal section tube, with luer hub	
127	08	HMI-GS-127	Set of 9 Pcs.	
128	08	HMI-GS-128	Set of 10 Pcs.	










129	08	HMI-GS-129	Set of 10 Pcs.	
130	08	HMI-GS-130	Set of 10 Pcs.	
131	08	HMI-GS-131	DISSECTING SET	
132	08	HMI-GS-132	Set of 6 pcs.	
133	08	HMI-GS-133	Set of 12 pcs.	
134	08	HMI-GS-134	DISSECTING KET Set of 2 pcs.	
135	SCALPEL HANDLE & AMPUTATION			
136				
137	09	HMI-GS-134B	#3 SCALPEL HANDLE 12.75 cm, 5" Blade Size 10, 11, 12, 15	
138	09	HMI-GS-135	#3 SCALPEL HANDLE/GRADUATED 12.75 cm, 5" Blade Size 10, 11, 12, 15	










139	09	HMI-GS-136	#4 SCALPEL HANDLE 12.75 cm, 5" Blade Size 20, 22, 25	
140	09	HMI-GS-137	4L SCALPEL HANDLE 21 cm, 8 1/4"	
141	09	HMI-GS-138	SCALPEL PLASTIC HANDLE # 8	
142	09	HMI-GS-139	COLLIN # 9 Blade Sizes Fig. 10, Fig. 11, Fig. 12, Fig. 15, Fig. 20, Fig. 22	
143	09	HMI-GS-140	SCALPEL PLASTIC HANDLE # 5	
144	09	HMI-GS-141	SCALPEL PLASTIC HANDLE # 6	
145	09	HMI-GS-142	#3, #4 SCALPEL HANDLE 16 cm, 6"	
146	09	HMI-GS-143	SCALPEL HANDLE 3L LONG 21 cm, 8 1/4" Blade Size 10, 11, 12, 15	







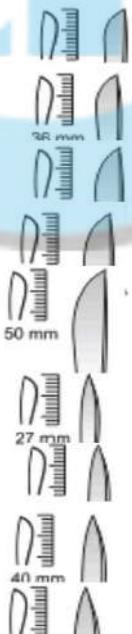
147	09	HMI-GS-144	#7 SCALPEL HANDLE 16.5 cm, 6 1/4" Blade 10, 11, 12, 15	
148	09	HMI-GS-145	SCALPEL HANDLE 4L long 21 cm, 8 1/4"	
149	09	HMI-GS-146	#3 SCALPEL HANDLE / LONG ANGLED 20.25 cm, 8 1/4" Blade Size 10, 11, 12, 15	
150	10	HMI-GS-147	SCALPEL HANDLE 16 cm, 6 1/4"	
151	10	HMI-GS-148	SCALPEL HANDLE 11.5 cm, 4 1/2"	
152	10	HMI-GS-149	SCALPEL HANDLE 12.7 cm, 5"	
153	10	HMI-GS-150	SCALPEL HANDLE 12.7 cm, 5"	
154	10	HMI-GS-151	SCALPEL HANDLE 11 cm, 4 1/4"	


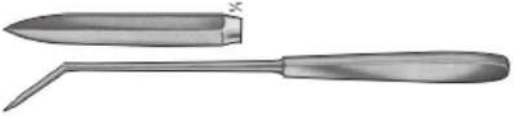

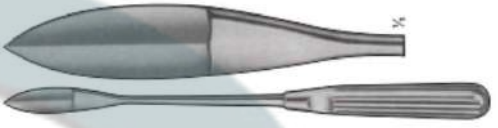




155	10	HMI-GS-152	SCALPEL HANDLE 13.5 cm, 5 1/4"	
156	10	HMI-GS-153	SCALPEL HANDLE 12 cm, 4 3/4"	
157	10	HMI-GS-154	TROUTMAN-CHRIS 9 cm, 3 1/2"	
158	10	HMI-GS-155	TROUTMAN-CHRIS 9 cm, 3 1/2"	
159	10	HMI-GS-156	BLADE HOLDER BLADE BREAKER 11 cm, 4 1/4"	
160	10	HMI-GS-157	CASTROVIEJO 13 cm, 5 1/4"	
161	11	HMI-GS-158	DIEFFENBACH Fig. 1 16 cm, 6 1/4"	      
162	11	HMI-GS-159	DIEFFENBACH Fig. 2 16 cm, 6 1/4"	
163	11	HMI-GS-160	DIEFFENBACH Fig. 3 16 cm, 6 1/4"	
164	11	HMI-GS-161	DIEFFENBACH Fig. 4 16 cm, 6 1/4"	
165	11	HMI-GS-162	DIEFFENBACH Fig. 5 16 cm, 6 1/4"	
166	11	HMI-GS-163	DIEFFENBACH Fig. 6 16 cm, 6 1/4"	









167	11	HMI-GS-164	DIEFFENBACH Fig. 7 16 cm, 6 1/4"	
168	11	HMI-GS-165	DIEFFENBACH Fig. 8 16 cm, 6 1/4"	
169	11	HMI-GS-166	DIEFFENBACH Fig. 9 16 cm, 6 1/4"	
170	11	HMI-GS-167	DIEFFENBACH Fig. 15 16 cm, 6 1/4"	
171	11	HMI-GS-168	DIEFFENBACH Fig. 16 16 cm, 6 1/4"	
172	11	HMI-GS-169	17 cm, 6 3/4"	
173	11	HMI-GS-170	DIEFFENBACH 16 cm, 6 1/4"	
174	11	HMI-GS-171	DISSECTING KNIFE 15 cm, 6" with metal handle	
175	11	HMI-GS-172	COLLIN Fig. 1 14.5 cm, 5 3/4"	
176	11	HMI-GS-173	COLLIN Fig. 2 14.5 cm, 5 3/4"	
177	11	HMI-GS-174	COLLIN Fig. 3 14.5 cm, 5 3/4"	
178	11	HMI-GS-175	COLLIN Fig. 4 14.5 cm, 5 3/4"	
179	11	HMI-GS-176	COLLIN Fig. 5 14.5 cm, 5 3/4"	
180	11	HMI-GS-177	COLLIN Fig. 6 14.5 cm, 5 3/4"	

181	11	HMI-GS-178	DIEFFENBACH Fig. 1 13.5 cm, 5 1/4"		
182	11	HMI-GS-179	DIEFFENBACH Fig. 2 13.5 cm, 5 1/4"		
183	11	HMI-GS-180	DIEFFENBACH Fig. 3 13.5 cm, 5 1/4"		
184	11	HMI-GS-181	DIEFFENBACH Fig. 4 13.5 cm, 5 1/4"		
185	11	HMI-GS-182	DIEFFENBACH Fig. 5 13.5 cm, 5 1/4"		
186	11	HMI-GS-183	DIEFFENBACH Fig. 6 13.5 cm, 5 1/4"		
187	11	HMI-GS-184	DIEFFENBACH Fig. 7 13.5 cm, 5 1/4"		
188	11	HMI-GS-185	DIEFFENBACH Fig. 8 13.5 cm, 5 1/4"		

189	11	HMI-GS-186	DIEFFENBACH Fig. 9 13.5 cm, 5 1/4"		
190	11	HMI-GS-187	DIEFFENBACH Fig. 10 13.5 cm, 5 1/4"		
191	12	HMI-GS-188	DISSECTING KNIVES 17 cm, 6 3/4"		
192	12	HMI-GS-189	DISSECTING KNIVES Fig. 1 17 cm, 6 3/4"		
193	12	HMI-GS-190	DISSECTING KNIVES Fig. 3 17 cm, 6 3/4"		
194	12	HMI-GS-191	DISSECTING KNIVES Fig. 5 17 cm, 6 3/4"		
195	12	HMI-GS-192	DISSECTING KNIVES Fig. 7 17 cm, 6 3/4"		
196	12	HMI-GS-193	DISSECTING KNIVES Fig. 9 17 cm, 6 3/4"		




197	12	HMI-GS-194	DISSECTING KNIVES Fig. 10 17 cm, 6 ¾"	
198	12	HMI-GS-195	DISSECTING KNIVES Fig. 12 17 cm, 6 ¾"	
199	12	HMI-GS-196	DISSECTING KNIVES Fig. 14 17 cm, 6 ¾"	
200	12	HMI-GS-197	DISSECTING KNIVES Fig. 16 17 cm, 6 ¾"	
201	12	HMI-GS-198	DISSECTING KNIVES Fig. 18 17 cm, 6 ¾"	
202	12	HMI-GS-199	DISSECTING KNIFE with metal handle 15 cm, 6"	 
203	12	HMI-GS-200	DISSECTING KNIFE with metal handle 15 cm, 6"	
204	12	HMI-GS-201	DISSECTING KNIFE with metal handle 15.5 cm, 6"	
205	12	HMI-GS-202	DISSECTING KNIFE with metal handle 16 cm, 6 ¼"	
206	12	HMI-GS-203	DISSECTING KNIFE with metal handle 16 cm, 6 ¼"	
207	12	HMI-GS-204	DISSECTING KNIFE with metal handle 15 cm, 6"	
208	12	HMI-GS-205	DISSECTING KNIFE with metal handle 15 cm, 6"	
209	12	HMI-GS-206	DISSECTING KNIFE with metal handle 16 cm, 6 ¼"	
210	12	HMI-GS-207	DISSECTING KNIFE with metal handle 16 cm, 6 ¼"	

211	12	HMI-GS-208	DISSECTING KNIFE with metal handle 17 cm, 6 3/4" "	
212	13	HMI-GS-209	AYRE 23.5 cm, 9" Cone Knife	
213	13	HMI-GS-210	23 cm, 9" Cone Knife	
214	13	HMI-GS-211	SEGOND 27 cm, 11" Myomatome	
215	13	HMI-GS-212	OLIVECRONA 20.5 cm, 8" Trigeminal knife	
216	13	HMI-GS-213	23 cm, 9" Trigeminal knife	
217	13	HMI-GS-214	FOWLER 20 cm, 8" Tonsil knife	
218	13	HMI-GS-215	ABRAHAM 21.5 cm, 8 1/4" Tonsil knife	

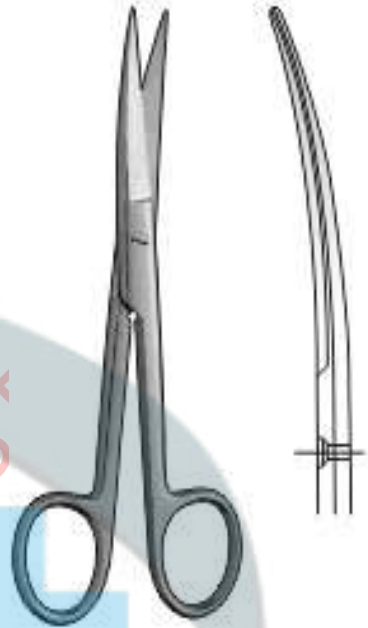
219	13	HMI-GS-216	BRUNINGS 21.5 cm, 8 ¼" Tonsil knife	
220	13	HMI-GS-217	DIEFFENBACH 13 cm, 5"	
221	13	HMI-GS-218	DIEFFENBACH 13 cm, 5"	
222	13	HMI-GS-219	SIMON 23.5 cm, 9 ¼"	
223	13	HMI-GS-220	SIMON 23.5 cm, 9 ¼" Fig.1	
224	13	HMI-GS-221	SIMON 23.5 cm, 9 ¼" Fig. 2	
225	13	HMI-GS-222	SIMON 23.5 cm, 9 ¼" Fig. 3	
226	13	HMI-GS-223	SIMON 23.5 cm, 9 ¼" Fig. 4	

227	14	HMI-GS-224	DISSECTING KNIFE 15 cm, 6" with metal handle, Fig.1, Fig.2, Fig.3, Fig.4, Fig.5, Fig.6, Fig.7, Fig.8, Fig.9, Fig.10		
228	14	HMI-GS-225	RAZOR Hollow Blades On Both Sides		
229	14	HMI-GS-226	RAZOR Blade Flat / Hollow		
230	14	HMI-GS-227	COLLIN Blade 13 cm, 5"		
231	14	HMI-GS-228	COLLIN Blade 16 cm, 6 1/4"		
232	14	HMI-GS-229	COLLIN Blade 19 cm, 7 1/2"		
233	14	HMI-GS-230	COLLIN Blade 22 cm, 8 1/2"		
234	14	HMI-GS-231	COLLIN Blade 28 cm, 11 1/4"		
235	14	HMI-GS-232	CATLIN Blade 16 cm, 6 1/4"		
236	14	HMI-GS-233	CATLIN Blade 19 cm, 7 1/2"		
237	14	HMI-GS-234	CATLIN Blade 22 cm, 8 1/2"		
238	14	HMI-GS-235	LISTON Blade 16 cm, 6 1/4"		
239	14	HMI-GS-236	LISTON Blade 19 cm, 7 1/2"		
240	14	HMI-GS-237	LISTON Blade 22 cm, 8 1/2"		
241	14	HMI-GS-238	LANGENBECK Blade 12 cm, 4 3/4"		

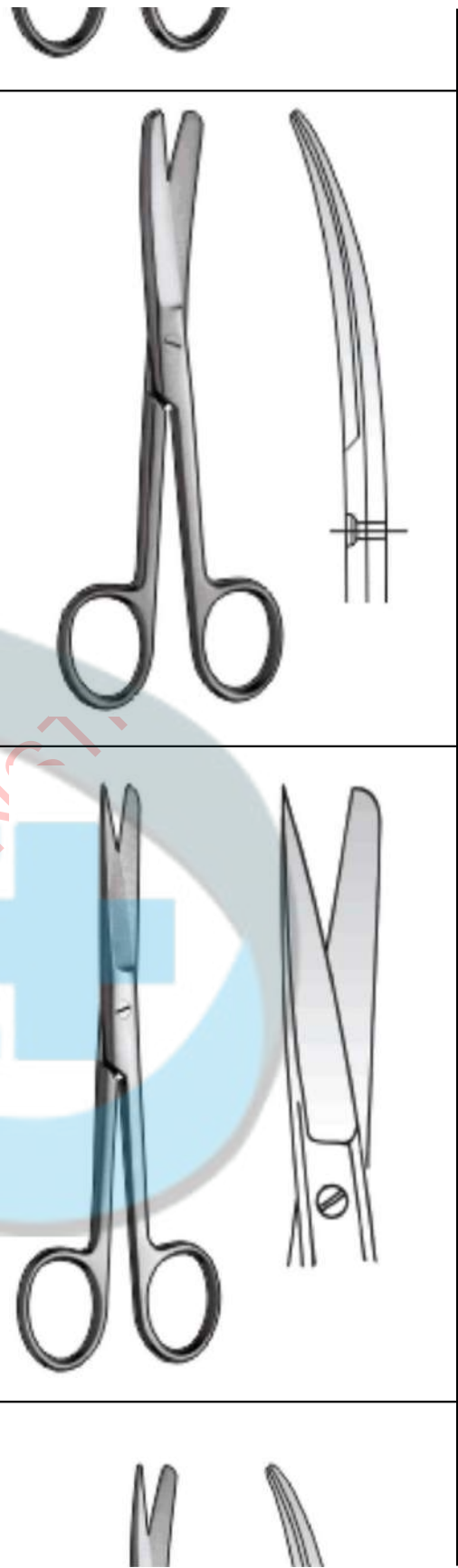
242	14	HMI-GS-239	RESECTION KNIFE 18 cm, 7"	
243	14	HMI-GS-240	AMPUTATION KNIFE 29 cm, 11 1/2"	
244	15	HMI-GS-241	COLLIN Blade 13 cm, 5"	
245	15	HMI-GS-242	COLLIN Blade 16 cm, 6 1/4"	
246	15	HMI-GS-243	COLLIN Blade 19 cm, 7 1/2"	
247	15	HMI-GS-244	COLLIN Blade 22 cm, 8 1/2"	
248	15	HMI-GS-245	COLLIN Blade 28 cm, 11 1/4"	
249	15	HMI-GS-246	CATLIN Blade 16 cm, 6 1/4"	
250	15	HMI-GS-247	CATLIN Blade 19 cm, 7 1/2"	
251	15	HMI-GS-248	CATLIN Blade 22 cm, 8 1/2"	
252	15	HMI-GS-249	LISTON Blade 16 cm, 6 1/4"	
253	15	HMI-GS-250	LISTON Blade 19 cm, 7 1/2"	
254	15	HMI-GS-251	LISTON Blade 22 cm, 8 1/2"	
255	15	HMI-GS-252	LANGENBECK Blade 12 cm, 4 3/4"	
256	15	HMI-GS-253	AMPUTATION KNIFE 29 cm, 11 1/2"	
257	15	HMI-GS-254	AMPUTATION KNIFE 32.5 cm, 13"	



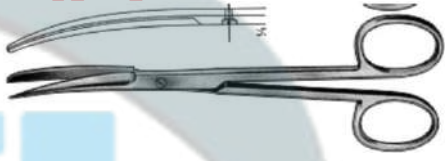
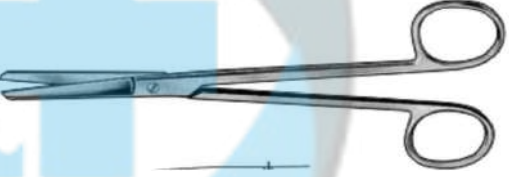
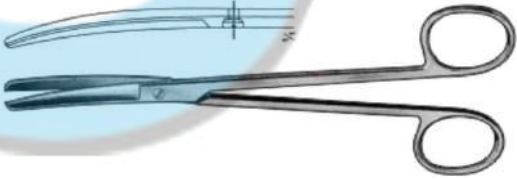
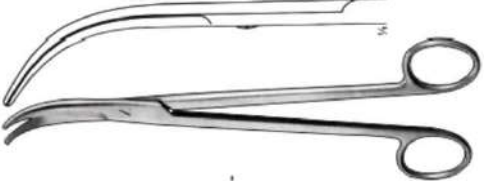
258	15	HMI-GS-255	CATLIN 29 cm, 11 1/2"	
259	15	HMI-GS-256	RESECTION KNIFE 18 cm, 7"	
260	15	HMI-GS-257	LANGENBECK 18 cm, 7"	
261	15	HMI-GS-258	LANGENBECK 18 cm, 7"	
262	15	HMI-GS-259	WALB 11 cm, 4 1/2"	
263	15	HMI-GS-260	WALB 14 cm, 5 1/2"	
264	15	HMI-GS-261	WALB 17 cm, 6 3/4"	
265	15	HMI-GS-262	VIRCHOW 16 cm, 6 1/4"	
266	15	HMI-GS-263	VIRCHOW 20 cm, 8"	
267	15	HMI-GS-264	VIRCHOW 24 cm, 9 1/2"	
268	SCISSORS			
269				
270	16	HMI-GS-265	OPERATING SCISSORS Standard Straight, 11.5 cm, 4 1/2"	
271	16	HMI-GS-266	OPERATING SCISSORS Standard Straight, 13.0 cm, 5", S/S Str.	
272	16	HMI-GS-267	OPERATING SCISSORS Standard Straight, 14.0 cm, 5 1/2", S/S Str.	
273	16	HMI-GS-268	OPERATING SCISSORS Standard Straight, 15.0 cm, 6", S/S Str.	







274	16	HMI-GS-269	OPERATING SCISSORS Standard Straight, 16.0 cm, 6 1/4", S/S Str.
275	16	HMI-GS-270	OPERATING SCISSORS Standard Straight, 17.5 cm, 7", S/S Str.
276	16	HMI-GS-271	OPERATING SCISSORS Standard Straight, 18.5 cm, 7 1/4", S/S Str.
277	16	HMI-GS-272	OPERATING SCISSORS Standard Straight, 20.0 cm, 8", S/S Str.
278	16	HMI-GS-273	OPERATING SCISSORS Standard Curved, 11.5 cm, 4 1/2", S/S Cvd.
279	16	HMI-GS-274	OPERATING SCISSORS Standard Curved, 13.0 cm, 5", S/S Cvd.
280	16	HMI-GS-275	OPERATING SCISSORS Standard Curved, 14.0 cm, 5 1/2", S/S Cvd.
281	16	HMI-GS-276	OPERATING SCISSORS Standard Curved, 15.0 cm, 6", S/S Cvd.
282	16	HMI-GS-277	OPERATING SCISSORS Standard Curved, 16.0 cm, 6 1/4", S/S Cvd.
283	16	HMI-GS-278	OPERATING SCISSORS Standard Curved, 17.5 cm, 7", S/S Cvd.
284	16	HMI-GS-279	OPERATING SCISSORS Standard Curved, 18.5 cm, 7 1/4", S/S Cvd.
285	16	HMI-GS-280	OPERATING SCISSORS Standard Curved, 20.0 cm, 8", S/S Cvd.
286	16	HMI-GS-281	OPERATING SCISSORS Standard Straight, 11.5 cm, 4 1/2", B/B Str.
287	16	HMI-GS-282	OPERATING SCISSORS Standard Straight, 13.0 cm, 5", B/B Str.
288	16	HMI-GS-283	OPERATING SCISSORS Standard Straight, 14.0 cm, 5 1/2", B/B Str.
289	16	HMI-GS-284	OPERATING SCISSORS Standard Straight, 15.0 cm, 6", B/B Str.
290	16	HMI-GS-285	OPERATING SCISSORS Standard Straight, 16.0 cm, 6 1/4", B/B Str.
291	16	HMI-GS-286	OPERATING SCISSORS Standard Straight, 17.5 cm, 7", B/B Str.
292	16	HMI-GS-287	OPERATING SCISSORS Standard Straight, 18.5 cm, 7 1/4", B/B Str.



293	16	HMI-GS-288	OPERATING SCISSORS Standard Straight, 20.0 cm, 8", B/B Str.
294	16	HMI-GS-289	OPERATING SCISSORS Standard Curved, 11.5 cm, 4 ½", B/B Cvd.
295	16	HMI-GS-290	OPERATING SCISSORS Standard Curved, 13.0 cm, 5", B/B Cvd.
296	16	HMI-GS-291	OPERATING SCISSORS Standard Curved, 14.0 cm, 5 ½", B/B Cvd.
297	16	HMI-GS-292	OPERATING SCISSORS Standard Curved, 15.0 cm, 6", B/B Cvd.
298	16	HMI-GS-293	OPERATING SCISSORS Standard Curved, 16.0 cm, 6 ¼", B/B Cvd.
299	16	HMI-GS-294	OPERATING SCISSORS Standard Curved, 17.5 cm, 7", B/B Cvd.
300	16	HMI-GS-295	OPERATING SCISSORS Standard Curved, 18.5 cm, 7 ¼", B/B Cvd.
301	16	HMI-GS-296	OPERATING SCISSORS Standard Curved, 20.0 cm, 8", B/B Cvd.
302	16	HMI-GS-297	OPERATING SCISSORS Standard Straight, 11.5 cm, 4 ½"
303	16	HMI-GS-298	OPERATING SCISSORS Standard Straight, 13.0 cm, 5"
304	16	HMI-GS-299	OPERATING SCISSORS Standard Straight, 14.0 cm, 5 ½"
305	16	HMI-GS-300	OPERATING SCISSORS Standard Straight, 15.0 cm, 6"
306	16	HMI-GS-301	OPERATING SCISSORS Standard Straight, 16.0 cm, 6 ¼"
307	16	HMI-GS-302	OPERATING SCISSORS Standard Straight, 17.5 cm, 7"
308	16	HMI-GS-303	OPERATING SCISSORS Standard Straight, 18.5 cm, 7 ¼"
309	16	HMI-GS-304	OPERATING SCISSORS Standard Straight, 20.0 cm, 8"
310	16	HMI-GS-305	OPERATING SCISSORS Standard Curved, 11.5 cm, 4 ½"
311	16	HMI-GS-306	OPERATING SCISSORS Standard Curved, 13.0 cm, 5"



312	16	HMI-GS-307	OPERATING SCISSORS Standard Curved, 14.0 cm, 5 1/2"	
313	16	HMI-GS-308	OPERATING SCISSORS Standard Curved, 15.0 cm, 6"	
314	16	HMI-GS-309	OPERATING SCISSORS Standard Curved, 16.0 cm, 6 1/4"	
315	16	HMI-GS-310	OPERATING SCISSORS Standard Curved, 17.5 cm, 7"	
316	16	HMI-GS-311	OPERATING SCISSORS Standard Curved, 18.5 cm, 7 1/4"	
317	16	HMI-GS-312	OPERATING SCISSORS Standard Curved, 20.0 cm, 8"	
318	17	HMI-GS-313	DEAVER Scissors 14.0 cm, 5 1/2"	
319	17	HMI-GS-314	DEAVER Scissors 14.0 cm, 5 1/2"	
320	17	HMI-GS-315	MIXTER Scissors 15.5 cm, 6"	
321	17	HMI-GS-316	MIXTER Scissors 15.5 cm, 6"	
322	17	HMI-GS-317	JORGENSON Scissors 22 cm, 8 1/2" Curved	

323	17	HMI-GS-318	INCISION SCISSORS 13.0 cm, 5"	
324	17	HMI-GS-319	INCISION SCISSORS 14.5 cm, 5 1/2"	
325	17	HMI-GS-320	INCISION SCISSORS 15.5 cm, 6"	
326	17	HMI-GS-321	RICHTER SCISSORS 14.5 cm, 5 1/2"	
327	17	HMI-GS-322	FERGUSSON SCISSORS 14.0 cm, 5 1/2"	
328	17	HMI-GS-323	FERGUSSON SCISSORS 16.5 cm, 6 1/2"	
329	17	HMI-GS-324	FERGUSSON SCISSORS 18.0 cm, 7"	
330	18	HMI-GS-325	MAYO Scissors Str. 14.5 cm, 5 1/2"	
331	18	HMI-GS-326	MAYO Scissors Str. 15.0 cm, 6"	
332	18	HMI-GS-327	MAYO Scissors Str. 17.0 cm, 6 3/4"	
333	18	HMI-GS-328	MAYO Scissors Cvd. 14.5 cm, 5 1/2"	
334	18	HMI-GS-329	MAYO Scissors Cvd. 15.0 cm, 6"	
335	18	HMI-GS-330	MAYO Scissors Cvd. 17.0 cm, 6"	
336	18	HMI-GS-331	MAYO-STILLE Scissors Str. 15.0 cm, 6"	
337	18	HMI-GS-332	MAYO-STILLE Scissors Str. 17.0 cm, 6 3/4"	
338	18	HMI-GS-333	MAYO-STILLE Scissors Cvd. 15.0 cm, 6"	


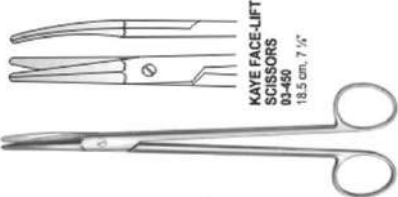

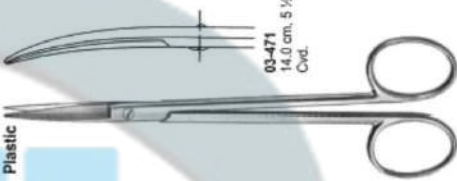

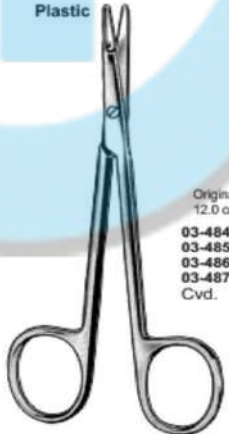
MAYO-STILLE
03-340 15.0 cm, 6"
03-341 17.0 cm, 6 3/4"
Str.

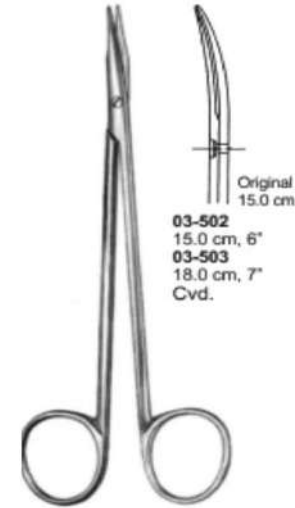
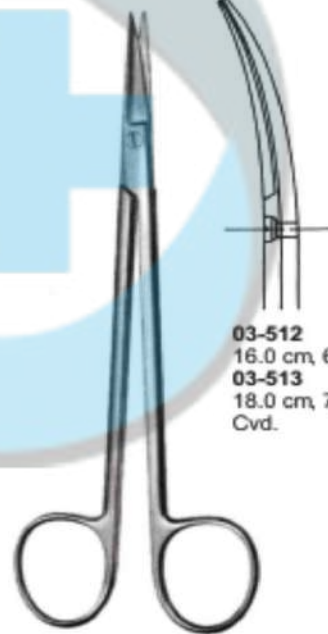
03-323
14.5 cm, 5 1/2"
03-324
15.0 cm, 6"
03-325
17.0 cm, 6 3/4"


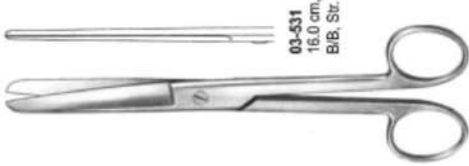
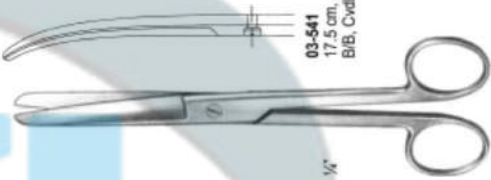


03-342
15.0 cm,
03-343
17.0 cm,
Cvd.






339	18	HMI-GS-334	MAYO-STILLE Scissors Cvd. 17.0 cm, 6 3/4"	<p>03-351 17.0 cm, 6 3/4" Cvd.</p> <p>MAYO-NOBLE 03-350 17.0 cm, 6 3/4" Str.</p>
340	18	HMI-GS-335	MAYO-NOBLE Scissors 17.0 cm, 6 3/4" Str.	
341	18	HMI-GS-336	MAYO-NOBLE Scissors 17.0 cm, 6 3/4" Cvd.	
342	18	HMI-GS-337	METZENBAUM Scissors 14.5 cm, 5 3/4" Str. & Cvd. B/B	<p>03-360 14.5 cm, 5 3/4" 03-361 18.0 cm, 7" 03-362 20.0 cm, 8" 03-363 23.0 cm, 9" 03-364 25.0 cm, 10" 03-365 28.0 cm, 11" Str. & Cvd.</p> <p>METZENBAUM Blunt / Blunt Str.</p>
343	18	HMI-GS-338	METZENBAUM Scissors 18.0 cm, 7" Str. & Cvd. B/B	
344	18	HMI-GS-339	METZENBAUM Scissors 20.0 cm, 8" Str. & Cvd. B/B	
345	18	HMI-GS-340	METZENBAUM Scissors 23.0 cm, 9" Str. & Cvd. B/B	
346	18	HMI-GS-341	METZENBAUM Scissors 25.0 cm, 10" Str. & Cvd. B/B	
347	18	HMI-GS-342	METZENBAUM Scissors 28.0 cm, 11" Str. & Cvd. B/B	
348	18	HMI-GS-343	METZENBAUM NELSON Scissor 14.5 cm, 5 3/4" Str. & Cvd.	
349	18	HMI-GS-344	METZENBAUM NELSON Scissor 18.0 cm, 7" Str. & Cvd.	
350	18	HMI-GS-345	METZENBAUM NELSON Scissor 20.0 cm, 8" Str. & Cvd.	
351	18	HMI-GS-346	METZENBAUM NELSON Scissor 23.0 cm, 9" Str. & Cvd.	
352	18	HMI-GS-347	METZENBAUM NELSON Scissor 25.0 cm, 10" Str. & Cvd.	
353	18	HMI-GS-348	METZENBAUM NELSON Scissor 28.0 cm, 11" Str. & Cvd.	

354	18	HMI-GS-349	METZENBAUM DISSECTING Scissors Curved 20.3 cm, 8"	
355	18	HMI-GS-350	METZENBAUM DISSECTING Scissors Curved 22.9 cm, 9"	
356	18	HMI-GS-351	METZENBAUM DISSECTING Scissors Curved 28.4 cm, 11"	
357	18	HMI-GS-352	METZENBAUM-JAMISON Scissors 15.25 cm, 6"	
358	18	HMI-GS-353	METZENBAUM-BABY Scissors 11.5 cm, 4 1/2" Str.	
359	18	HMI-GS-354	METZENBAUM-BABY Scissors 11.5 cm, 4 1/2" Cvd.	
360	18	HMI-GS-355	THOREK Scissors 19.0 cm, 7 1/2"	
361	19	HMI-GS-356	LEXER-BABY Scissors 10.0 cm, 4" Str	



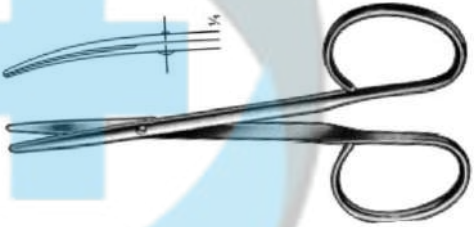
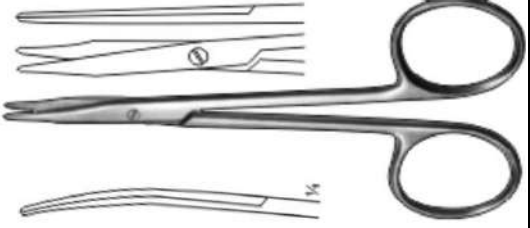
362	19	HMI-GS-357	LEXER-BABY Scissors 10.0 cm, 4" Cvd	
363	19	HMI-GS-358	KAYE FACE-LIFT Scissors 18.5 cm, 7 1/4"	 KAYE FACE-LIFT SCISSORS 03-450 18.5 cm, 7 1/4"
364	19	HMI-GS-359	FOMON Scissors 13.5 cm, 5 1/4"	 03-460 13.5 cm, 5 1/4"
365	19	HMI-GS-360	JOSEPH Scissors 14.0 cm, 5 1/2" Str.	 03-471 14.0 cm, 5 1/2" Cvd.
366	19	HMI-GS-361	JOSEPH Scissors 14.0 cm, 5 1/2" Cvd.	 JOSEPH 03-470
367	19	HMI-GS-362	KILNER Scissors 12.0 cm, 4 3/4" Str.	 Plastic Original 12.0 cm 03-484 12.0 cm, 4 3/4" 03-485 15.0 cm, 6" 03-486 18.0 cm, 7" 03-487 20.0 cm, 8" Cvd. KILNER 03-480 12.0 cm, 4 3/4" 03-481 15.0 cm, 6" 03-482 18.0 cm, 7" 03-483 20.0 cm, 8" Str.
368	19	HMI-GS-363	KILNER Scissors 15.0 cm, 6" Str.	
369	19	HMI-GS-364	KILNER Scissors 18.0 cm, 7" Str.	
370	19	HMI-GS-365	KILNER Scissors 20.0 cm, 8" Str.	
371	19	HMI-GS-366	KILNER Scissors 12.0 cm, 4 3/4" Cvd.	
372	19	HMI-GS-367	KILNER Scissors 15.0 cm, 6" Cvd.	
373	19	HMI-GS-368	KILNER Scissors 18.0 cm, 7" Cvd.	
374	19	HMI-GS-369	KILNER Scissors 20.0 cm, 8" Cvd.	


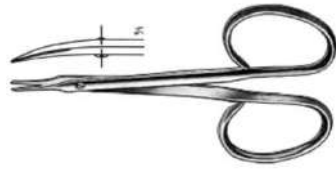
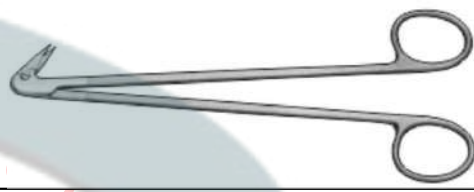


375	19	HMI-GS-370	REYNOLDS Scissors 15.0 cm, 6", Str.	 <p>Original 15.0 cm</p> <p>03-502 15.0 cm, 6" 03-503 18.0 cm, 7" Cvd.</p> <p>REYNOLDS 03-500 15.0 cm, 6" 03-501 18.0 cm, 7" Str.</p>
376	19	HMI-GS-371	REYNOLDS Scissors 18.0 cm, 7", Str.	
377	19	HMI-GS-372	REYNOLDS Scissors 15.0 cm, 6" Cvd.	
378	19	HMI-GS-373	REYNOLDS Scissors 18.0 cm, 7" Cvd.	
379	19	HMI-GS-374	KELLY Scissors 16.0 cm, 6 1/4" Str.	 <p>03-512 16.0 cm, 6 1/4" 03-513 18.0 cm, 7" Cvd.</p> <p>KELLY 03-510 16.0 cm, 6 1/4" 03-511 18.0 cm, 7" Str.</p>
380	19	HMI-GS-375	KELLY Scissors 18.0 cm, 7" Str.	
381	19	HMI-GS-376	KELLY Scissors 16.0 cm, 6 1/4" Cvd.	
382	19	HMI-GS-377	KELLY Scissors 18.0 cm, 7" Cvd.	


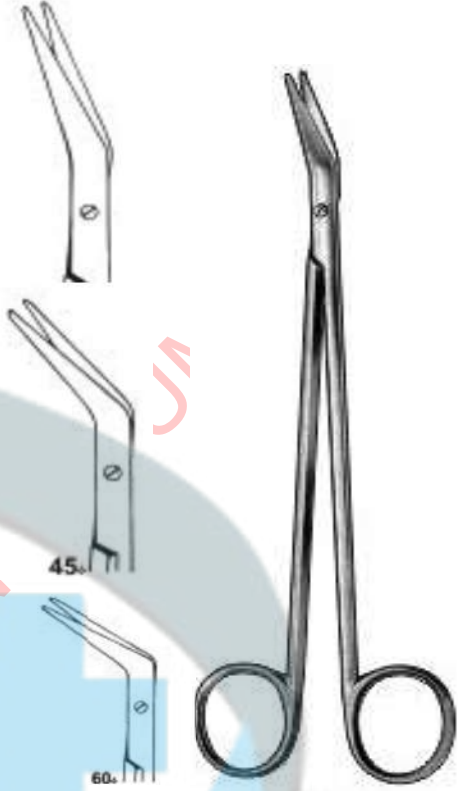
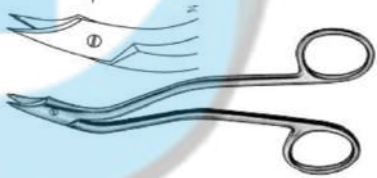
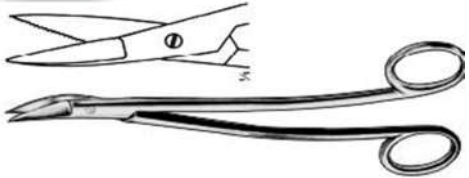

383	20	HMI-GS-378	DOYEN Scissors 16.0 cm, 6 1/4" S/B, Str.	
384	20	HMI-GS-379	DOYEN Scissors 16.0 cm, 6 1/4" B/B, Str.	
385	20	HMI-GS-380	DOYEN Scissors 16.0 cm, 6 1/4" B/B, Str.	
386	20	HMI-GS-381	DOYEN Scissors 17.5 cm, 6 3/4" B/B, Str.	
387	20	HMI-GS-382	DOYEN Scissors 17.5 cm, 6 3/4" B/B, Cvd.	
388	20	HMI-GS-383	CARDINALE Scissors 28.0 cm, 11"	
389	20	HMI-GS-384	SIMS Scissors 20.0 cm, 8" Straight, B/B	
390	20	HMI-GS-385	SIMS Scissors 23.0 cm, 9" Straight, B/B	


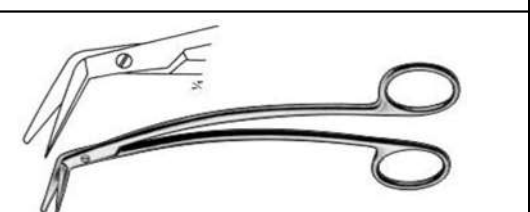
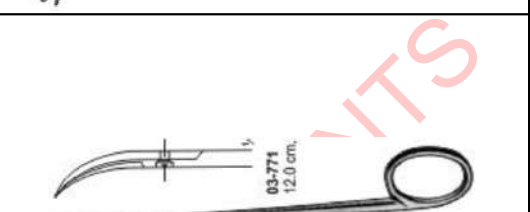

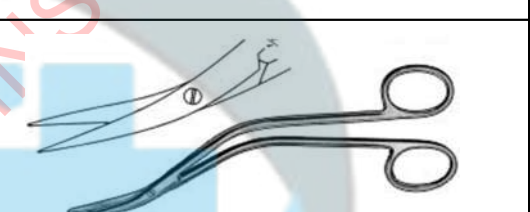
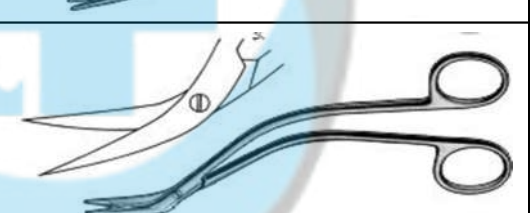

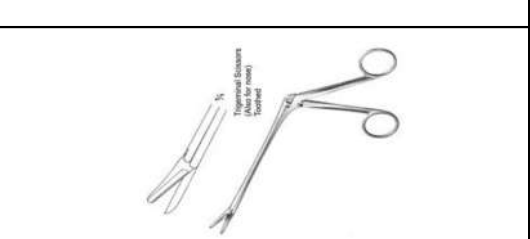
391	20	HMI-GS-386	SIMS Scissors 20.0 cm, 8" S/B	
392	20	HMI-GS-387	SIMS Scissors 23.0 cm, 9" S/B	
393	20	HMI-GS-388	SIMS Scissors 20.0 cm, 8" S/S	
394	20	HMI-GS-389	SIMS Scissors 23.0 cm, 9" S/S	
395	20	HMI-GS-390	SIMS Scissors 20.0 cm, 8" S/B	
396	20	HMI-GS-391	SIMS Scissors 23.0 cm, 9" S/B	
397	20	HMI-GS-392	SIMS Scissors 20.0 cm, 8" S/S	
398	20	HMI-GS-393	SIMS Scissors 23.0 cm, 9" S/S	
399	20	HMI-GS-394	IRIS SCISSORS 09 cm, 3 1/2" Str.	





400	20	HMI-GS-395	IRIS SCISSORS 10.5 cm, 4 1/4" Str.		
401	20	HMI-GS-396	IRIS SCISSORS 11.5 cm, 4 1/2" Str.		
402	20	HMI-GS-397	IRIS SCISSORS 12.0 cm, 4 3/4" Str.		
403	20	HMI-GS-398	IRIS SCISSORS 09 cm, 3 1/2" Cvd.		
404	20	HMI-GS-399	IRIS SCISSORS 10.5 cm, 4 1/4" Cvd.		
405	20	HMI-GS-400	IRIS SCISSORS 11.5 cm, 4 1/2" Cvd.		
406	20	HMI-GS-401	IRIS SCISSORS 12.0 cm, 4 3/4" Cvd.		
407	20	HMI-GS-402	IRIS ANGULAR Scissors 11cm 4 1/4"		
408	20	HMI-GS-403	KILLNER Scissors 11.5 cm, 4 1/2" Straight, sharp/sharp		
409	20	HMI-GS-404	STRABISMUS Scissors 11.5 cm, 4 1/2" Curved		
410	20	HMI-GS-405	STRABISMUS Scissors 11.5 cm, 4 1/2" Straight		
411	21	HMI-GS-406	POTTS-REYNOLDS TENOTOMY Scissors 12.0 cm, 4 3/4" Curved		




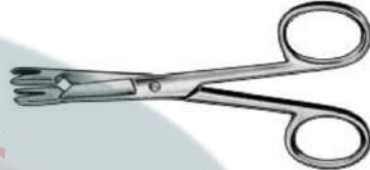




412	21	HMI-GS-407	POTTS TENOTOMY Scissors 15.2 cm, 6"	
413	21	HMI-GS-408	POTTS TENOTOMY Scissors 17.8 cm, 7"	
414	21	HMI-GS-409	POTTS TENOTOMY Scissors 20.3 cm, 8"	
415	21	HMI-GS-410	SLAYER Scissors 10 cm	
416	21	HMI-GS-411	Scissors 10.0 cm, 4" Straight	
417	21	HMI-GS-412	Scissors 10.0 cm, 4" Curved	
418	21	HMI-GS-413	TENOTOMY-STEVENSON Scissors 11 cm, 4 1/4" Straight	
419	21	HMI-GS-414	TENOTOMY-STEVENSON Scissors 11 cm, 4 1/4" Curved	


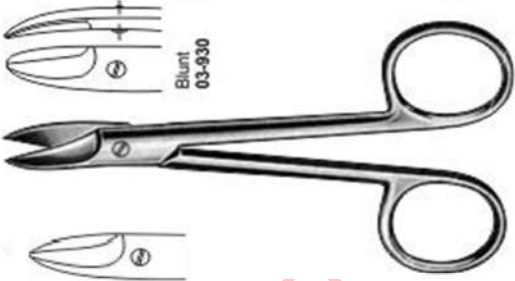






420	21	HMI-GS-415	TENOTOMY Scissors 9.5 cm, 3 3/4" Straight	 <p>03-661 9.5 cm, 3 3/4" Curved</p>
421	21	HMI-GS-416	TENOTOMY Scissors 9.5 cm, 3 3/4" Curved	
422	21	HMI-GS-417	TENOTOMY Scissors 9.5 cm, 3 3/4" Curved-Ribbon Handles blunt/blunt	
423	21	HMI-GS-418	COOLEY REVERSE Cut Scissors angled 120° 17.1 cm, 6 3/4"	
424	22	HMI-GS-419	POTTS-SMITH Scissors 19.1 cm, 7 1/2" angled 25°	 <p>Delicate Blade 13 mm</p>
425	22	HMI-GS-420	POTTS-SMITH Scissors 13.3 cm, 5 1/4" angled 45°	
426	22	HMI-GS-421	POTTS-SMITH Scissors 19.1 cm, 7 1/2" angled 45°	
427	22	HMI-GS-422	POTTS-SMITH Scissors 19.1 cm, 7 1/2" angled 60°	
428	22	HMI-GS-423	POTTS-SMITH Scissors 19.1 cm, 7 1/2" angled 90°	
429	22	HMI-GS-424	POTTS-SMITH Scissors 19.0 cm, 7 1/2" angled 25°	
430	22	HMI-GS-425	POTTS-SMITH Scissors 19.0 cm, 7 1/2" angled 45°	


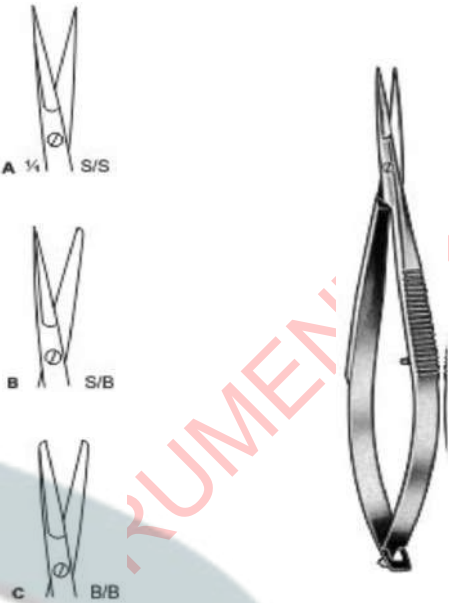



431	22	HMI-GS-426	POTTS-SMITH Scissors 19.0 cm, 7 1/2" angled 60°	
432	22	HMI-GS-427	DE BAKEY Scissors 16.0 cm, 6 1/4" angled 25°	
433	22	HMI-GS-428	DE BAKEY Scissors 19.0 cm, 7 1/2" angled 25°	
434	22	HMI-GS-429	DE BAKEY Scissors 23.0 cm, 9" angled 25°	
435	22	HMI-GS-430	DE BAKEY Scissors 28.0 cm, 11" angled 25°	
436	22	HMI-GS-431	DE BAKEY Scissors 16.0 cm, 6 1/4" angled 45°	
437	22	HMI-GS-432	DE BAKEY Scissors 19.0 cm, 7 1/2" angled 45°	
438	22	HMI-GS-433	DE BAKEY Scissors 23.0 cm, 9" angled 45°	
439	22	HMI-GS-434	DE BAKEY Scissors 28.0 cm, 11" angled 45°	
440	22	HMI-GS-435	DE BAKEY Scissors 16.0 cm, 6 1/4" angled 60°	
441	22	HMI-GS-436	DE BAKEY Scissors 19.0 cm, 7 1/2" angled 60°	
442	22	HMI-GS-437	DE BAKEY Scissors 23.0 cm, 9" angled 60°	
443	22	HMI-GS-438	DE BAKEY Scissors 28.0 cm, 11" angled 60°	
444	22	HMI-GS-439	HEATH Scissors 15.0 cm, 6"	
445	22	HMI-GS-440	ENT-DEAN Scissors 17 cm, 6 3/4" Serrated	
446	22	HMI-GS-441	STRULLY Scissors 22.0 cm, 8 3/4"	





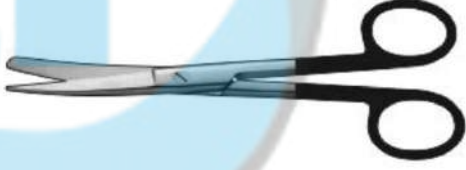

447	22	HMI-GS-442	STRULLY Scissors 22.0 cm, 8 3/4"	
448	22	HMI-GS-443	FAVALORO Scissors 15.0 cm, 6"	
449	23	HMI-GS-444	QUINBY Scissors 12.0 cm, 4 3/4"	
450	23	HMI-GS-445	QUINBY Scissors 12.0 cm, 4 3/4"	
451	23	HMI-GS-446	DE BAKEY Scissors 15.5 cm, 6"	
452	23	HMI-GS-447	DE BAKEY Scissors 15.5 cm, 6"	
453	23	HMI-GS-448	ENTEROTOMY Scissors 21.0 cm, 8 1/4"	
454	23	HMI-GS-449	OLIVECRONA Scissors 23 cm	






455	23	HMI-GS-450	DISSECTING Scissors 11.5 cm, 4 1/4"	
456	23	HMI-GS-451	DISSECTING Scissors 13.0 cm, 5"	
457	23	HMI-GS-452	DISSECTING Scissors 14.0 cm, 5 1/2"	
458	23	HMI-GS-453	DISSECTING Scissors 11.5 cm, 4 1/4"	
459	23	HMI-GS-454	DISSECTING Scissors 13.0 cm, 5"	
460	23	HMI-GS-455	DISSECTING Scissors 14.0 cm, 5 1/2"	
461	23	HMI-GS-456	MC INDOE Scissors 19.0 cm, 7 1/2"	
462	23	HMI-GS-457	HEYMANN Scissors 18 cm, 7"	



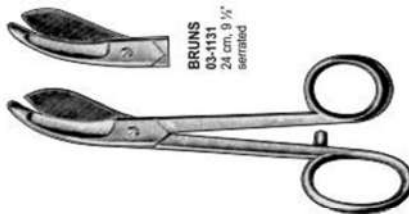
463	23	HMI-GS-458	COTTLE Scissors 16 cm 6 1/4"	
464	24	HMI-GS-459	ROUND CUT Scissors 23.5 cm, 9"	
465	24	HMI-GS-460	LE GRANGE Scissors 11 cm, 4 1/4"	
466	24	HMI-GS-461	SCHOEMAKER-LOTH Scissors 12.5 cm, 5"	
467	24	HMI-GS-462	SPENCER / DELICATE Scissors 11 cm, 4 1/2"	
468	24	HMI-GS-463	LITTAUER Scissors 14 cm, 5 1/2"	
469	24	HMI-GS-464	MODIFIED-USA Scissors 10 cm, 4"	
470	24	HMI-GS-465	BEEBEE Scissors 10.5 cm, 4" Blunt, Straight	

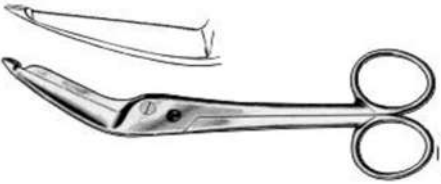






471	24	HMI-GS-466	BEEBEE Scissors 10.5 cm, 4" Pointed, Straight	
472	24	HMI-GS-467	BEEBEE Scissors 10.5 cm, 4" Blunt Curved	
473	24	HMI-GS-468	BEEBEE Scissors 10.5 cm, 4" Pointed Curved	
474	24	HMI-GS-469	UNIVERSAL Scissors 11.5 cm, 4 1/2"	
475	25	HMI-GS-470	CASTROVIEJO Scissors 9.0 cm, 3 1/2" B/B	
476	25	HMI-GS-471	CASTROVIEJO Scissors 9.0 cm, 3 1/2" B/B	
477	25	HMI-GS-472	CASTROVIEJO Scissors 9.0 cm, 3 1/2" B/S	
478	25	HMI-GS-473	CASTROVIEJO Scissors 9.0 cm, 3 1/2" S/S	



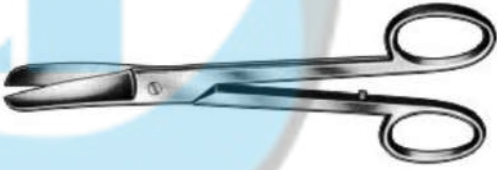


479	25	HMI-GS-474	NOYES Scissors 12 cm, 4 3/4"	
480	25	HMI-GS-475	NOYES Scissors s/s 12 cm, 4 3/4"	
481	25	HMI-GS-476	NOYES Scissors s/b 12 cm, 4 3/4"	
482	25	HMI-GS-477	NOYES Scissors b/b 12 cm, 4 3/4"	
483	25	HMI-GS-478	WESTCOTT Scissors 11.5 cm, 4 1/2"	
484	25	HMI-GS-479	WESTCOTT Scissors 11.5 cm, 4 1/2"	
485	25	HMI-GS-480	WESTCOTT Scissors 11 cm, 4 1/4" Curved Sharp/Sharp	
486	25	HMI-GS-481	WESTCOTT Scissors 11 cm, 4 1/4" Curved-Micro Sharp/Sharp	





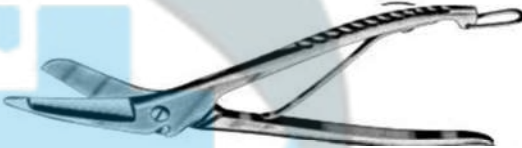

487	25	HMI-GS-482	WESTCOTT Scissors 11 cm, 4 1/4" Curved Blunt/Blunt	 
488	25	HMI-GS-483	BARRAQUER Scissors 5.5 cm, 2 1/4"	
489	25	HMI-GS-484	BARRAQUER Scissors 5.5 cm, 2 1/4"	
490	25	HMI-GS-485	BARRAQUER Scissors 5.5 cm, 2 1/4"	
491	26	HMI-GS-486	STANDARD Super Cut Scissors 14 cm, 5 1/2" Straight	
492	26	HMI-GS-487	STANDARD Super Cut Scissors 14 cm, 5 1/2" Curved	
493	26	HMI-GS-488	MAYO Super Cut Scissors 14 cm, 5 1/2"	
494	26	HMI-GS-489	MAYO Super Cut Scissors 15 cm, 6"	
495	26	HMI-GS-490	MAYO Super Cut Scissors 18 cm, 7"	
496	26	HMI-GS-491	MAYO Super Cut Scissors 20 cm, 8"	
497	26	HMI-GS-492	MAYO Super Cut Scissors 23 cm, 9"	







498	26	HMI-GS-493	MAYO Super Cut Scissors 23 cm, 9"Curved	
499	26	HMI-GS-494	MAYO Super Cut Scissors 23 cm, 9"Straight	
500	26	HMI-GS-495	GOLDMAN-FOX Super Cut Scissors 9.0 cm, 3 1/2" Straight	
501	26	HMI-GS-496	GOLDMAN-FOX Super Cut Scissors 9.0 cm, 3 1/2" Curved	
502	26	HMI-GS-497	STEVENS TENOTOMY Super Cut Scissors 9.0 cm, 3 1/2" Straight	
503	26	HMI-GS-498	STEVENS TENOTOMY Super Cut Scissors 9.0 cm, 3 1/2" Curved	
504	26	HMI-GS-499	IRIS Super Cut Scissors 9.0 cm, 3 1/2"	
505	26	HMI-GS-500	IRIS Super Cut Scissors 11.4 cm, 4 1/2" Straight	


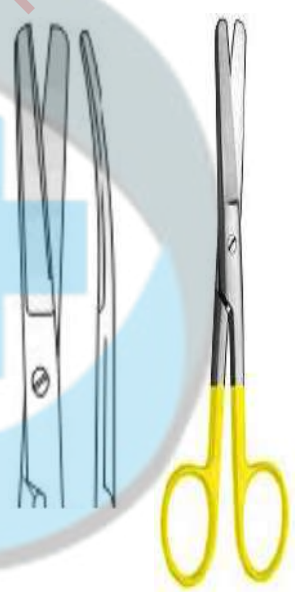
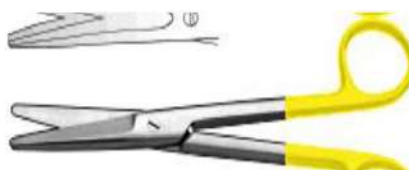
506	26	HMI-GS-501	IRIS Super Cut Scissors Angular 11.4 cm, 4 1/2"	
507	27	HMI-GS-502	UNIVERSAL Scissors 14.5 cm, 5 3/4" 143 C/290 F Autoclavable	
508	27	HMI-GS-503	UNIVERSAL Scissors 15 cm, 6" 143 C/290 F Autoclavable	
509	27	HMI-GS-504	UNIVERSAL Scissors 16 cm, 6 1/4" 143 C/290 F Autoclavable	
510	27	HMI-GS-505	UNIVERSAL Scissors 18 cm, 7" 143 C/290 F Autoclavable	
511	27	HMI-GS-506	UNIVERSAL BANDAGE Scissors 12 cm, 5"	
512	27	HMI-GS-507	BRUNS Scissors 24 cm, 9 1/2" saw edge	
513	27	HMI-GS-508	BRUNS Scissors 24 cm, 9 1/2" serrated	



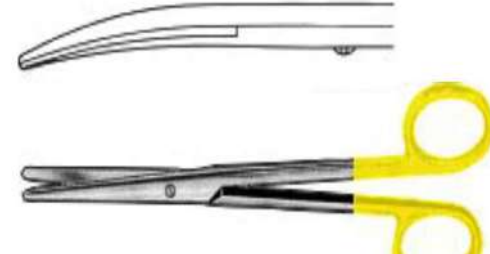
514	27	HMI-GS-509	LISTER Scissors Exentric 19 cm, 7 ½"	
515	27	HMI-GS-510	BERGMANN Scissors 23 cm, 9"	
516	27	HMI-GS-511	ESMARCH Scissors 20 cm, 8"	
517	27	HMI-GS-512	ESMARCH Scissors 22 cm, 8 ¾"	
518	27	HMI-GS-513	BRAUN-STADLER Scissors 14 cm, 5 ½"	
519	27	HMI-GS-514	BRAUN-STADLER Scissors 20 cm, 8"	
520	27	HMI-GS-515	SMITH (MOD. USA) Scissors 16 cm, 6 ¼"	
521	27	HMI-GS-516	SMITH (MOD. USA) Scissors 18 cm, 7"	
522	27	HMI-GS-517	SMITH (MOD. USA) Scissors 20 cm, 8"	
523	27	HMI-GS-518	SMITH (MOD. USA) Scissors 23 cm, 9"	
524	28	HMI-GS-519	KNOWLES Scissors 14 cm, 5 ½"	










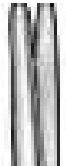
525	28	HMI-GS-520	LISTER Scissors 21.0 cm, 8 1/4"	
526	28	HMI-GS-521	LISTER BANDAGE Scissors 14 cm, 5 1/2"	
527	28	HMI-GS-522	LISTER BANDAGE Scissors 16 cm, 6 1/4"	
528	28	HMI-GS-523	LISTER BANDAGE Scissors 18 cm, 7"	
529	28	HMI-GS-524	LISTER BANDAGE Scissors 20 cm, 8"	
530	28	HMI-GS-525	LORENZ Scissors 23 cm, 9"	
531	28	HMI-GS-526	KNOWLES Scissors 14 cm, 5 1/2"	
532	28	HMI-GS-527	LISTER-EXCENTRIC Scissors 16 cm, 6 1/4"	

533	28	HMI-GS-528	LISTER-EXCENTRIC Scissors 19 cm, 7 ½"	
534	28	HMI-GS-529	KNOWLES Scissors 14cm	
535	28	HMI-GS-530	ESMARCH Scissors 20cm	
536	28	HMI-GS-531	SEUTIN Scissors 23cm	
537	28	HMI-GS-532	WIRE & CLOTHING Scissors 20cm	
538	29	HMI-GS-533	STILLE Shear 23cm	
539	29	HMI-GS-534	STILLE Shear 26cm	
540	29	HMI-GS-535	STILLE Shear 37cm	

541	29	HMI-GS-536	ENGEL Shear	
542	29	HMI-GS-537	REINER Shear 18cm	
543	29	HMI-GS-538	FINGER Shear 16cm	
544	29	HMI-GS-539	WOLFF Shear 19cm	
545	29	HMI-GS-540	WOLFF Shear 23cm	
546	29	HMI-GS-541	WOLFF Shear 26cm	
547	29	HMI-GS-542	HENING Shear 28cm	
548	29	HMI-GS-543	BEESON Shear 30cm	




549	30	HMI-GS-544	STANDARD OPERATING SCISSORS T/C INSERTED 14.5 cm, 5 3/4" Straight	
550	30	HMI-GS-545	STANDARD OPERATING SCISSORS T/C INSERTED 14.5 cm, 5 3/4" Curved	
551	30	HMI-GS-546	STANDARD OPERATING SCISSORS T/C INSERTED 16.5 cm, 6 1/2" Straight	
552	30	HMI-GS-547	STANDARD OPERATING SCISSORS T/C INSERTED 16.5 cm, 6 1/2" Curved	
553	30	HMI-GS-548	STANDARD OPERATING SCISSORS T/C INSERTED 18.5 cm, 7 1/4" Straight	
554	30	HMI-GS-549	STANDARD OPERATING SCISSORS T/C INSERTED 18.5 cm, 7 1/4" Curved	
555	30	HMI-GS-550	STANDARD OPERATING SCISSORS T/C INSERTED 14.5 cm, 5 3/4" Straight	
556	30	HMI-GS-551	STANDARD OPERATING SCISSORS T/C INSERTED 14.5 cm, 5 3/4" Curved	
557	30	HMI-GS-552	STANDARD OPERATING SCISSORS T/C INSERTED 16.5 cm, 6 1/2" Straight	
558	30	HMI-GS-553	STANDARD OPERATING SCISSORS T/C INSERTED 16.5 cm, 6 1/2" Curved	
559	30	HMI-GS-554	STANDARD OPERATING SCISSORS T/C INSERTED 18.5 cm, 7 1/4" Straight	
560	30	HMI-GS-555	STANDARD OPERATING SCISSORS T/C INSERTED 18.5 cm, 7 1/4" Curved	
561	30	HMI-GS-556	MAYO OPERATING SCISSORS T/C INSERTED blunt/blunt 14 cm, 5 1/2"	
562	30	HMI-GS-557	MAYO OPERATING SCISSORS T/C INSERTED blunt/blunt 17 cm, 6 3/4"	

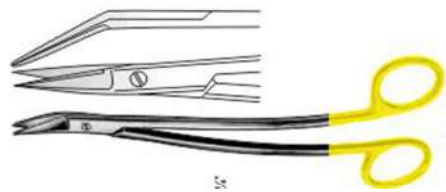
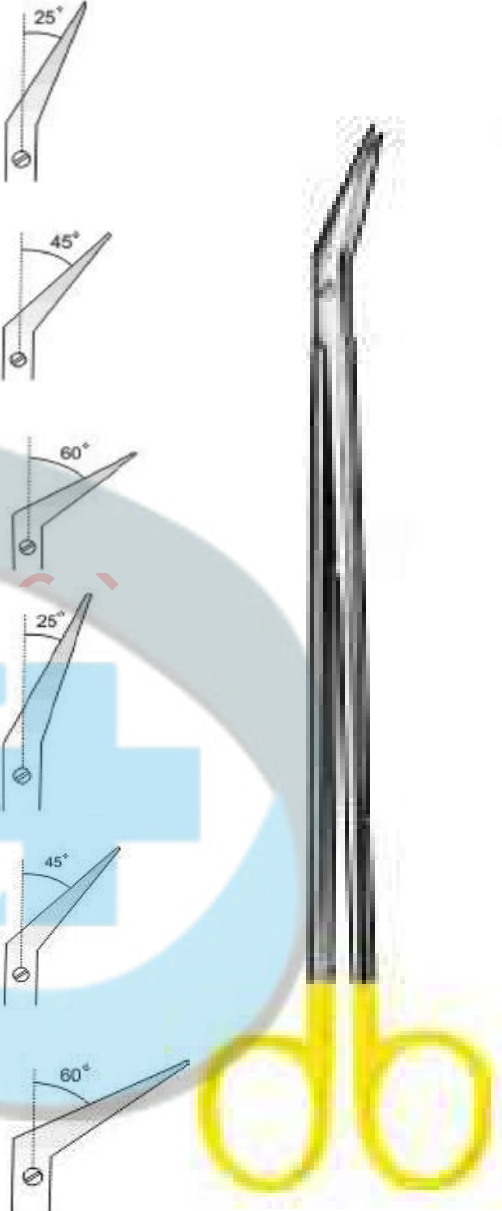

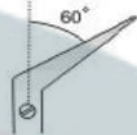

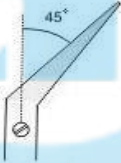
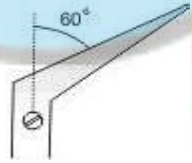

563	30	HMI-GS-558	MAYO OPERATING SCISSORS T/C INSERTED blunt/blunt 23 cm, 9"	
564	30	HMI-GS-559	STANDARD OPERATING SCISSORS T/C INSERTED 14.5 cm, 5 3/4" Straight	
565	30	HMI-GS-560	STANDARD OPERATING SCISSORS T/C INSERTED 14.5 cm, 5 3/4" Curved	
566	30	HMI-GS-561	STANDARD OPERATING SCISSORS T/C INSERTED 16.5 cm, 6 1/2" Straight	
567	30	HMI-GS-562	STANDARD OPERATING SCISSORS T/C INSERTED 16.5 cm, 6 1/2" Curved	
568	30	HMI-GS-563	STANDARD OPERATING SCISSORS T/C INSERTED 18.5 cm, 7 1/4" Straight	
569	30	HMI-GS-564	STANDARD OPERATING SCISSORS T/C INSERTED 18.5 cm, 7 1/4" Curved	
570	30	HMI-GS-565	MAYO-STILLE OPERATING SCISSORS T/C INSERTED blunt/blunt, Str. 15 cm, 6"	
571	30	HMI-GS-566	MAYO-STILLE OPERATING SCISSORS T/C INSERTED blunt/blunt, Str. 17 cm, 6 3/4"	
572	30	HMI-GS-567	MAYO-STILLE OPERATING SCISSORS T/C INSERTED blunt/blunt, cvd. 15 cm, 6"	
573	30	HMI-GS-568	MAYO-STILLE OPERATING SCISSORS T/C INSERTED blunt/blunt, cvd. 17 cm, 6 3/4"	
574	30	HMI-GS-569	LEXER OPERATING SCISSORS T/C INSERTED blunt/blunt, Str. 16 cm, 6 1/4"	
575	30	HMI-GS-570	LEXER OPERATING SCISSORS T/C INSERTED blunt/blunt, Str. 21.5 cm, 8 1/2"	
576	30	HMI-GS-571	LEXER OPERATING SCISSORS T/C INSERTED 16 cm, 6 1/4" blunt/blunt, Cvd.	



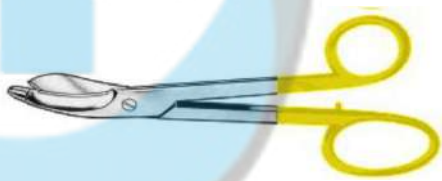


577	30	HMI-GS-572	LEXER OPERATING SCISSORS T/C INSERTED 21.5 cm, 8 ½" blunt/blunt, Cvd.	
578	31	HMI-GS-573	PARAMETRIUM SCISSORS T/C INSERTED 23 cm, 9" blunt/blunt Str.	
579	31	HMI-GS-574	PARAMETRIUM SCISSORS T/C INSERTED blunt/blunt Cvd.	
580	31	HMI-GS-575	PARAMETRIUM SCISSORS T/C INSERTED blunt/blunt Full Cvd.	 
581	31	HMI-GS-576	GOLDMAN-FOX SCISSORS T/C INSERTED 13.0 cm, 5"	 
582	31	HMI-GS-577	CARDINALE SCISSORS T/C INSERTED 28.0 cm, 11"	
583	31	HMI-GS-578	SIMS SCISSORS T/C INSERTED 23.0 cm, 9" Curved	 
584	31	HMI-GS-579	METZENBAUM DELICATE SCISSORS T/C INSERTED 14.5 cm, 5 ¾" Blunt / Blunt Curved	
585	31	HMI-GS-580	METZENBAUM DELICATE SCISSORS T/C INSERTED 18.0 cm, 7" Blunt / Blunt Curved	
586	31	HMI-GS-581	METZENBAUM DELICATE SCISSORS T/C INSERTED 20.0 cm, 8" Blunt / Blunt Curved	




587	31	HMI-GS-582	METZENBAUM DELICATE SCISSORS T/C INSERTED 23.0 cm, 9" Blunt / Blunt Curved
588	31	HMI-GS-583	METZENBAUM DELICATE SCISSORS T/C INSERTED 25.0 cm, 10" Blunt / Blunt Curved
589	31	HMI-GS-584	METZENBAUM DELICATE SCISSORS T/C INSERTED 28.0 cm, 11" Blunt / Blunt Curved
590	31	HMI-GS-585	METZENBAUM DELICATE SCISSORS T/C INSERTED 14.5 cm, 5 3/4" Blunt / Blunt Straight
591	31	HMI-GS-586	METZENBAUM DELICATE SCISSORS T/C INSERTED 18.0 cm, 7" Blunt / Blunt Straight
592	31	HMI-GS-587	METZENBAUM DELICATE SCISSORS T/C INSERTED 20.0 cm, 8" Blunt / Blunt Straight
593	31	HMI-GS-588	METZENBAUM DELICATE SCISSORS T/C INSERTED 23.0 cm, 9" Blunt / Blunt Straight
594	31	HMI-GS-589	METZENBAUM DELICATE SCISSORS T/C INSERTED 25.0 cm, 10" Blunt / Blunt Straight
595	31	HMI-GS-590	METZENBAUM DELICATE SCISSORS T/C INSERTED 28.0 cm, 11" Blunt / Blunt Straight
596	31	HMI-GS-591	METZENBAUM DELICATE SCISSORS T/C INSERTED 14.5 cm, 5 3/4" Sharp / Sharp Curved
597	31	HMI-GS-592	METZENBAUM DELICATE SCISSORS T/C INSERTED 18.0 cm, 7" Sharp / Sharp Curved
598	31	HMI-GS-593	METZENBAUM DELICATE SCISSORS T/C INSERTED 20.0 cm, 8" Sharp / Sharp Curved
599	31	HMI-GS-594	METZENBAUM DELICATE SCISSORS T/C INSERTED 23.0 cm, 9" Sharp / Sharp Curved
600	31	HMI-GS-595	METZENBAUM DELICATE SCISSORS T/C INSERTED 25.0 cm, 10" Sharp / Sharp Curved








601	31	HMI-GS-596	METZENBAUM DELICATE SCISSORS T/C INSERTED 28.0 cm, 11" Sharp / Sharp Curved	
602	31	HMI-GS-597	METZENBAUM DELICATE SCISSORS T/C INSERTED 14.5 cm, 5 3/4" Sharp / Sharp Straight	
603	31	HMI-GS-598	METZENBAUM DELICATE SCISSORS T/C INSERTED 18.0 cm, 7" Sharp / Sharp Straight	
604	31	HMI-GS-599	METZENBAUM DELICATE SCISSORS T/C INSERTED 20.0 cm, 8" Sharp / Sharp Straight	
605	31	HMI-GS-600	METZENBAUM DELICATE SCISSORS T/C INSERTED 23.0 cm, 9" Sharp / Sharp Straight	
606	31	HMI-GS-601	METZENBAUM DELICATE SCISSORS T/C INSERTED 25.0 cm, 10" Sharp / Sharp Straight	
607	31	HMI-GS-602	METZENBAUM DELICATE SCISSORS T/C INSERTED 28.0 cm, 11" Sharp / Sharp Straight	
608	32	HMI-GS-603	KELLY SCISSORS T/C INSERTED 16 cm, 6 1/4" Straight	
609	32	HMI-GS-604	KELLY SCISSORS T/C INSERTED 16 cm, 6 1/4" Curved	
610	32	HMI-GS-605	GUM SCISSORS T/C INSERTED Locklin 16 cm, 6 1/4"	
611	32	HMI-GS-606	GUM SCISSORS T/C INSERTED 16 cm, 6 1/4" Locklin	

612	32	HMI-GS-607	DEAN SCISSORS T/C INSERTED 17.5 cm, 6 ¾"	
613	32	HMI-GS-608	DEBAKEY SCISSORS T/C INSERTED 16.5 cm 6 ½" Angle 25o	
614	32	HMI-GS-609	DEBAKEY SCISSORS T/C INSERTED 18.0 cm 7" Angle 45o	
615	32	HMI-GS-610	DEBAKEY SCISSORS T/C INSERTED 18.5cm 7 ¼" Angle 60o	
616	32	HMI-GS-611	DEBAKEY SCISSORS T/C INSERTED 19.0 cm 7 ½" Angle 25o	
617	32	HMI-GS-612	DEBAKEY SCISSORS T/C INSERTED 22.0 cm 8 ¾" Angle 45o	
618	32	HMI-GS-613	DEBAKEY SCISSORS T/C INSERTED 23.0 cm 9" Angle 60o	
619	32	HMI-GS-614	IRIS SCISSORS T/C INSERTED 11cm 4 ½"	

620	32	HMI-GS-615	IRIS SCISSORS T/C INSERTED 11.5cm 4 ½"	
621	32	HMI-GS-616	LISTER BANDAGE SCISSORS T/C INSERTED 14 cm, 5 ½"	
622	32	HMI-GS-617	LISTER BANDAGE SCISSORS T/C INSERTED 16 cm, 6 ¼"	
623	32	HMI-GS-618	LISTER BANDAGE SCISSORS T/C INSERTED 18 cm, 7"	
624	32	HMI-GS-619	LISTER BANDAGE SCISSORS T/C INSERTED 20 cm, 8"	
625	32	HMI-GS-620	BRUNS SCISSORS T/C INSERTED 21 cm, 8 ¼" For heavy duty use Longlife cutting edge	
626	32	HMI-GS-621	WIRE CUTTING SCISSORS T/C INSERTED 11.5 cm, 4 ½"	
DRESSING AND TISSUE FORCEPS				
629	33	HMI-GS-622	STANDARD 10.5 cm, 4"	
630	33	HMI-GS-623	STANDARD 11.5 cm, 4 ½"	
631	33	HMI-GS-624	STANDARD 12.5 cm, 5"	







632	33	HMI-GS-625	STANDARD 14.0 cm, 5 ½"	
633	33	HMI-GS-626	STANDARD 16.0 cm 6 ¼ "	
634	33	HMI-GS-627	STANDARD 18.0 cm, 7"	
635	33	HMI-GS-628	STANDARD 20.0 cm, 8"	
636	33	HMI-GS-629	STANDARD 25.0 cm, 10"	
637	33	HMI-GS-630	STANDARD 30.0 cm, 12"	
638	33	HMI-GS-631	STANDARD 1:2 10.5 cm, 4"	
639	33	HMI-GS-632	STANDARD 1:2 11.5 cm 4 ½"	
640	33	HMI-GS-633	STANDARD 1:2 12.5 cm 5"	
641	33	HMI-GS-634	STANDARD 1:2 14.0 cm, 5 ½"	
642	33	HMI-GS-635	STANDARD 1:2 16.0 cm 6 ¼ "	
643	33	HMI-GS-636	STANDARD 1:2 18.0 cm, 7"	
644	33	HMI-GS-637	STANDARD 1:2 20.0 cm, 8"	
645	33	HMI-GS-638	STANDARD 1:2 25.0 cm. 10"	
646	33	HMI-GS-639	STANDARD 1:2 30.0 cm, 12"	
647	33	HMI-GS-640	SEMKEN 12.5 cm, 5"	
648	33	HMI-GS-641	SEMKEN 15.5 cm, 6"	
649	33	HMI-GS-642	SEMKEN 1:2 12.5 cm, 5"	







650	33	HMI-GS-643	SEMKEN 1:2 15.0 cm, 6"	
651	33	HMI-GS-644	SEMKEN 1:2 12.5 cm, 5"	
652	33	HMI-GS-645	SEMKEN 1:2 15.0 cm, 6"	
653	33	HMI-GS-646	BROPHY 20 cm, 8"	
654	33	HMI-GS-647	BROPHY 20 cm, 8"	
655	33	HMI-GS-648	BROPHY 1:2 20 cm, 8"	
656	33	HMI-GS-649	BROPHY 1:2 20 cm, 8"	
657	33	HMI-GS-650	POOTS-SMITH 18 cm, 7"	





658	33	HMI-GS-651	POOTS-SMITH 21 cm, 8.5"
659	33	HMI-GS-652	POOTS-SMITH 25 cm, 10"
660	33	HMI-GS-653	POOTS-SMITH 18 cm, 7"
661	33	HMI-GS-654	POOTS-SMITH 21 cm, 8.5"
662	33	HMI-GS-655	POOTS-SMITH 25 cm, 10"
663	33	HMI-GS-656	POTTS-SMITH 1:2 18 cm, 7"
664	33	HMI-GS-657	POTTS-SMITH 1:2 21 cm, 8"
665	33	HMI-GS-658	POTTS-SMITH 1:2 25 cm, 10"












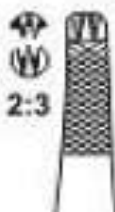
HEALERMED INSTUMENTS


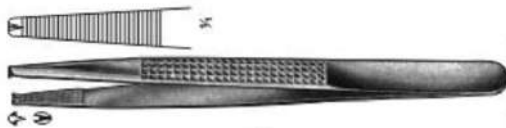

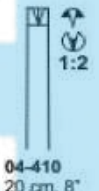



666	33	HMI-GS-659	POTTS-SMITH 1:2 18 cm, 7"	
667	33	HMI-GS-660	POTTS-SMITH 1:2 21 cm, 8"	
668	33	HMI-GS-661	POTTS-SMITH 1:2 25 cm, 10"	
669	33	HMI-GS-662	GERALD 18 cm, 7"	
670	33	HMI-GS-663	GERALD 1:2 17 cm, 6.75"	
671	33	HMI-GS-664	GERALD 1:2 17 cm, 6.75"	
672	33	HMI-GS-665	CUSHING 17.5 cm, 7"	
673	33	HMI-GS-666	CUSHING 1:2 17.5 cm, 7"	


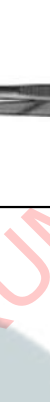






674	33	HMI-GS-667	CUSHING 1:2 17.5 cm, 7"	
675	33	HMI-GS-668	WANGENSTEEN 23 cm, 9"	
676	34	HMI-GS-669	TAYLOR 1:2 17.5 cm, 7"	
677	34	HMI-GS-670	TAYLOR 1:2 17.5 cm, 7"	
678	34	HMI-GS-671	GILLIES 1:2 15 cm, 6"	
679	34	HMI-GS-672	11.5 cm 4 1/2"	
680	34	HMI-GS-673	13.0 cm 5"	
681	34	HMI-GS-674	14.5 cm 5 1/2"	
682	34	HMI-GS-675	16.0 cm 6 1/4"	
683	34	HMI-GS-676	18.0 cm 7"	
684	34	HMI-GS-677	20.0 cm 8"	
685	34	HMI-GS-678	25.0 cm 10"	
686	34	HMI-GS-679	30.0 cm 12"	

687	34	HMI-GS-680	13 cm, 5"	
688	34	HMI-GS-681	14.5 cm, 5 1/2"	
689	34	HMI-GS-682	16 cm, 6 1/4"	
690	34	HMI-GS-683	13 cm, 5"	
691	34	HMI-GS-684	14.5 cm, 5 1/2"	
692	34	HMI-GS-685	16 cm, 6 1/4"	
693	34	HMI-GS-686	STILLE 1:2 15 cm, 6"	
694	34	HMI-GS-687	STILLE 2:3 15 cm, 6"	

695	34	HMI-GS-688	MCINDOE 15.0 cm, 6" Dissecting Forceps non-toothed, serrated jaws.	
696	34	HMI-GS-689	JEAN 1:2 14.0 cm, 5 1/2" Dissecting Forceps one into two teeth on serrated jaws.	
697	34	HMI-GS-690	JEAN 1:2 18.0 cm, 7" Dissecting Forceps one into two teeth on serrated jaws.	
698	34	HMI-GS-691	TREVES 1:2 12.5 cm, 5" Dissecting Forceps teeth, on smooth jaws.	
699	34	HMI-GS-692	TREVES 1:2 15.0 cm, 6" Dissecting Forceps teeth, on smooth jaws.	
700	34	HMI-GS-693	TREVES 1:2 18.0 cm, 7" Dissecting Forceps teeth, on smooth jaws.	
701	34	HMI-GS-694	RAMSAY 1:2 18.0 cm, 7" Dissecting Forceps one into teeth on serrated jaws. As above but into three teeth.	
702	34	HMI-GS-695	12.5 cm, 5" Dissecting Forceps turn over end, serrated jaws.	

703	34	HMI-GS-696	15.0 cm, 6" Dissecting Forceps turn over end, serrated jaws.	
704	34	HMI-GS-697	18.0 cm, 7" Dissecting Forceps turn over end, serrated jaws.	
705	34	HMI-GS-698	FERRIS-SMITH 1:2 18 cm, 7"	
706	35	HMI-GS-699	FERRIS-SMITH 1:2 18 cm, 7"	
707	35	HMI-GS-700	FERRIS-SMITH 1:2 18 cm, 7"	
708	35	HMI-GS-701	LANE 1:2 12.5cm, 5 1/2"	
709	35	HMI-GS-702	LANE 1:2 15 cm, 6"	
710	35	HMI-GS-703	LANE 1:2 17 cm, 6 3/4"	
711	35	HMI-GS-704	LANE 1:2 18 cm, 7"	
712	35	HMI-GS-705	LANE 1:2 20 cm, 8"	
713	35	HMI-GS-706	LANE 1:2 12.5cm, 5 1/2"	
714	35	HMI-GS-707	LANE 1:2 15.0cm, 6"	
715	35	HMI-GS-708	LANE 1:2 17.0cm, 6 3/4"	
716	35	HMI-GS-709	LANE 1:2 18.0cm, 7"	

717	35	HMI-GS-710	LANE 1:2 20.0cm, 8"	
718	35	HMI-GS-711	BONNEY 1:2 18 cm, 7"	
719	35	HMI-GS-712	RUSSIAN-MODELL 15 cm, 5 3/4" Grasping, Serrated	 Grasping, Serrated
720	35	HMI-GS-713	RUSSIAN-MODELL 20 cm, 8" Grasping, Serrated	
721	35	HMI-GS-714	RUSSIAN-MODELL 25 cm, 10" Grasping, Serrated	
722	35	HMI-GS-715	DUEHRSEN 1:2 20 cm, 8"	 04-410 20 cm, 8"
723	35	HMI-GS-716	DUEHRSEN 2:3 20 cm, 8"	 04-411 20 cm, 8"
724	35	HMI-GS-717	DUEHRSEN 3:4 20 cm, 8"	 04-412 20 cm, 8"
725	35	HMI-GS-718	DUEHRSEN 20 cm, 8"	

726	35	HMI-GS-719	MAYO-RUSSIAN 15.5cm, 6" Grasping, serrated	
727	35	HMI-GS-720	MAYO-RUSSIAN 23.0cm, 9" Grasping, serrated	
728	35	HMI-GS-721	DAVIS 25 cm, 10"	
729	35	HMI-GS-722	COLLIN-DUVAL 20 cm, 8"	
730	35	HMI-GS-723	COLLIN-DUVAL 20 cm, 8"	
731	35	HMI-GS-724	COLLIN-DUVAL 20 cm, 8"	
732	35	HMI-GS-725	YASARGIL-SAMI Jaws Spoon-Shaped 24 cm, 9 1/4" 3mm	
733	35	HMI-GS-726	YASARGIL-SAMI Jaws Spoon-Shaped 24 cm, 9 1/4" 5mm	



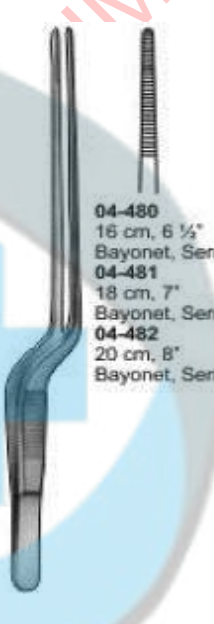
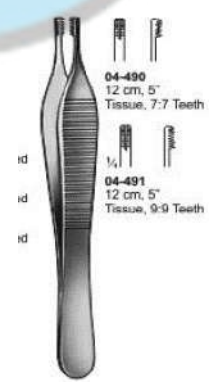
Grasping,
serrated



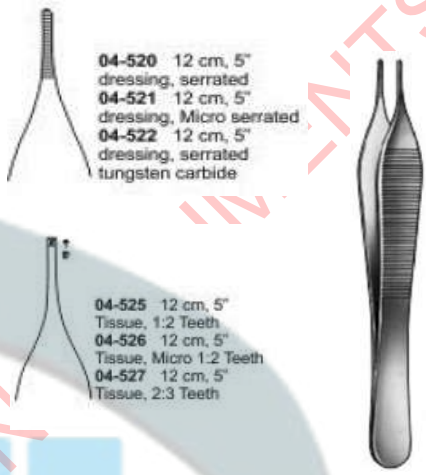
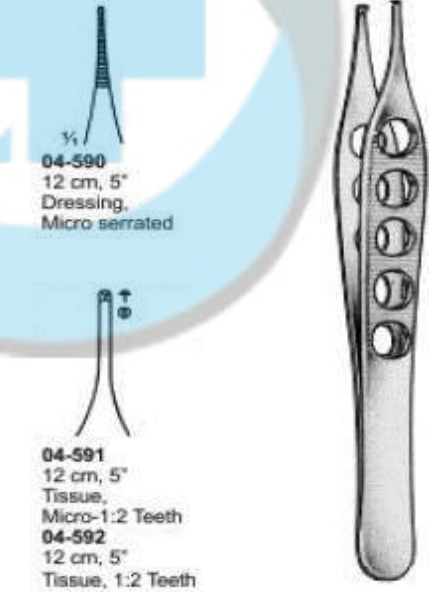
04-450
20 cm, 8"

04-451
20 cm, 8"

04-452
20 cm, 8"

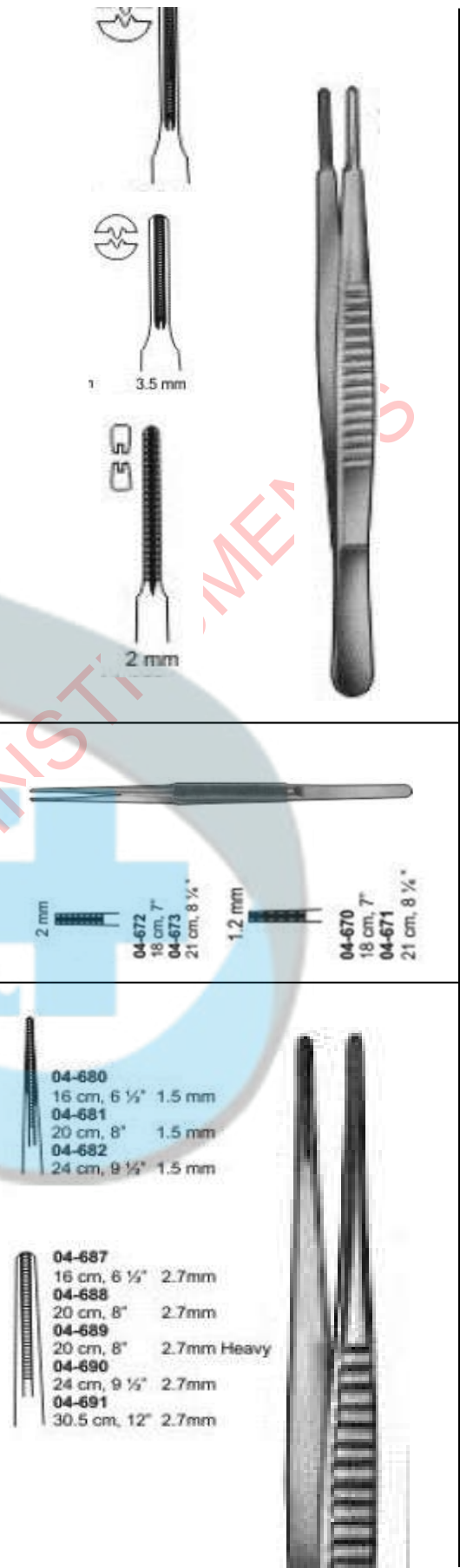
04-460 3mm
04-461 5mm
04-462 7mm

734	35	HMI-GS-727	YASARGIL-SAMI Jaws Spoon-Shaped 24 cm, 9 1/4" 7mm	
735	35	HMI-GS-728	LUCAE / ENT 14 cm, 5 1/2" Dressing, Serrated	 <p>04-470 14 cm, 5 1/2" Dressing, Serrated</p> <p>04-471 16 cm, 6 1/2" Dressing, Serrated</p>
736	35	HMI-GS-729	LUCAE / ENT 16 cm, 6 1/2" Dressing, Serrated	
737	36	HMI-GS-730	JANSEN-GRUENWALD 16 cm, 6 1/2" Bayonet, Serrated	 <p>04-480 16 cm, 6 1/2" Bayonet, Serrated</p> <p>04-481 18 cm, 7" Bayonet, Serrated</p> <p>04-482 20 cm, 8" Bayonet, Serrated</p>
738	36	HMI-GS-731	JANSEN-GRUENWALD 18 cm, 7" Bayonet, Serrated	
739	36	HMI-GS-732	JANSEN-GRUENWALD 20 cm, 8" Bayonet, Serrated	
740	36	HMI-GS-733	ADSON-BROWN 12 cm, 5" Tissue, 7:7 Teeth	 <p>04-490 12 cm, 5" Tissue, 7:7 Teeth</p> <p>04-491 12 cm, 5" Tissue, 9:9 Teeth</p>
741	36	HMI-GS-734	ADSON-BROWN 12 cm, 5" Tissue, 9:9 Teeth	

742	36	HMI-GS-735	ADSON-BROWN 12 cm, 5"	
743	36	HMI-GS-736	BROWN 15 cm, 6" Straight, 9:9 Teeth	
744	36	HMI-GS-737	ADSON / MICRO-ADSON 12 cm, 5" dressing, serrated tungsten carbide	 <p>04-520 12 cm, 5" dressing, serrated 04-521 12 cm, 5" dressing, Micro serrated 04-522 12 cm, 5" dressing, serrated tungsten carbide</p> <p>04-525 12 cm, 5" Tissue, 1:2 Teeth 04-526 12 cm, 5" Tissue, Micro 1:2 Teeth 04-527 12 cm, 5" Tissue, 2:3 Teeth</p>
745	36	HMI-GS-738	ADSON / MICRO-ADSON 12 cm, 5" dressing, Micro serrated tungsten carbide	
746	36	HMI-GS-739	ADSON / MICRO-ADSON 12 cm, 5" dressing, serrated tungsten carbide	
747	36	HMI-GS-740	ADSON / MICRO-ADSON 12 cm, 5" Tissue, 1:2 Teeth	
748	36	HMI-GS-741	ADSON / MICRO-ADSON 12 cm, 5" Tissue, Micro 1:2 Teeth	
749	36	HMI-GS-742	ADSON / MICRO-ADSON 12 cm, 5" Tissue, 2:3 Teeth	
750	36	HMI-GS-743	LIGHTWEIGHT-ADSON 12 cm, 5" Dressing, Micro serrated	 <p>04-590 12 cm, 5" Dressing, Micro serrated</p> <p>04-591 12 cm, 5" Tissue, Micro-1:2 Teeth 04-592 12 cm, 5" Tissue, 1:2 Teeth</p>
751	36	HMI-GS-744	LIGHTWEIGHT-ADSON 12 cm, 5" Tissue, Micro-1:2 Teeth	
752	36	HMI-GS-745	LIGHTWEIGHT-ADSON 12 cm, 5" Tissue, 1:2 Teeth	

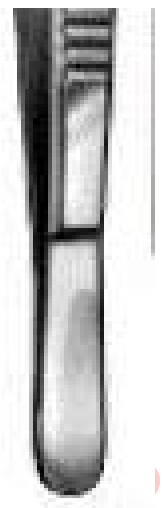
753	36	HMI-GS-746	DE BAKEY / LIGHTWEIGHT 16 cm, 6 1/2"	
754	36	HMI-GS-747	DE BAKEY 1.5mm 16 cm, 6 1/2"	 04-610 1.5mm 04-611 2.0mm 16 cm, 6 1/2"
755	36	HMI-GS-748	DE BAKEY 2.0mm 16 cm, 6 1/2"	
756	36	HMI-GS-749	DE BAKEY 2.0mm 16 cm, 6 1/2"	
757	36	HMI-GS-750	MODELL USA 14.5 cm, 6"	 1/4 04-620 14.5 cm, 6"
758	36	HMI-GS-751	MODELL USA 14.5 cm, 6" 1:2 teeth	 1/4 04-630 14.5 cm, 6" 1:2 teeth
759	36	HMI-GS-752	MCINDOE 15 cm, 6"	 1/4 MCINDOE 04-640 15 cm, 6"
760	36	HMI-GS-753	GILLIES 15 cm, 6" 1:2 teeth	
761	37	HMI-GS-754	DEBAKEY 15cm, 6" 2.7 mm	

762	37	HMI-GS-755	DEBAKEY 20cm, 8" 2.7 mm
763	37	HMI-GS-756	DEBAKEY 24cm, 9 1/2" 2.7 mm
764	37	HMI-GS-757	DEBAKEY 30cm, 12" 2.7 mm
765	37	HMI-GS-758	DEBAKEY 15cm, 6" 3.5 mm
766	37	HMI-GS-759	DEBAKEY 20cm, 8" 3.5 mm
767	37	HMI-GS-760	DEBAKEY 24cm, 9 1/2" 3.5 mm
768	37	HMI-GS-761	DEBAKEY 30cm, 12" 3.5 mm
769	37	HMI-GS-762	DEBAKEY 15cm, 6" 2 mm
770	37	HMI-GS-763	DEBAKEY 20cm, 8" 2 mm
771	37	HMI-GS-764	DEBAKEY 24cm, 9 1/2" 2 mm
772	37	HMI-GS-765	DEBAKEY 30cm, 12" 2 mm
773	37	HMI-GS-766	DEBAKEY 18 cm, 7" 1.2 mm
774	37	HMI-GS-767	DEBAKEY 21 cm, 8 1/4" 1.2 mm
775	37	HMI-GS-768	DEBAKEY 18 cm, 7" 2 mm
776	37	HMI-GS-769	DEBAKEY 21 cm, 8 1/4" 2 mm
777	37	HMI-GS-770	DEBAKEY 16 cm, 6 1/2" 1.5 mm
778	37	HMI-GS-771	DEBAKEY 20 cm, 8" 1.5 mm
779	37	HMI-GS-772	DEBAKEY 24 cm, 9 1/2" 1.5 mm
780	37	HMI-GS-773	DEBAKEY 16 cm, 6 1/2" 2.0mm
781	37	HMI-GS-774	DEBAKEY 20 cm, 8" 2.0mm
782	37	HMI-GS-775	DEBAKEY 24 cm, 9 1/2" 2.0mm
783	37	HMI-GS-776	DEBAKEY 30.5 cm, 12" 2.0mm
784	37	HMI-GS-777	DEBAKEY 16 cm, 6 1/2" 2.7mm
785	37	HMI-GS-778	DEBAKEY 20 cm, 8" 2.7mm



786	37	HMI-GS-779	DEBAKEY 20 cm, 8" 2.7mm Heavy
787	37	HMI-GS-780	DEBAKEY 24 cm, 9 1/2" 2.7mm
788	37	HMI-GS-781	DEBAKEY 30.5 cm, 12" 2.7mm
789	37	HMI-GS-782	DEBAKEY 16 cm, 6 1/2" 3.5mm
790	37	HMI-GS-783	DEBAKEY 20 cm, 8" 3.5mm
791	37	HMI-GS-784	DEBAKEY 24 cm, 9 1/2" 3.5mm
792	37	HMI-GS-785	DEBAKEY 30.5 cm, 12" 3.5mm
793	37	HMI-GS-786	DE BAKEY 16 cm, 6 1/2" 2.0mm
794	37	HMI-GS-787	DE BAKEY 20 cm, 8" 2.0mm
795	37	HMI-GS-788	DE BAKEY 24 cm, 9 1/2" 2.0mm
796	37	HMI-GS-789	DE BAKEY 30 cm, 12" 2.0mm
797	37	HMI-GS-790	KUEHNE 10.5cm, 4"





- 04-692
16 cm, 6 1/2" 3.5mm
- 04-693
20 cm, 8" 3.5mm
- 04-694
24 cm, 9 1/2" 3.5mm
- 04-695
30.5 cm, 12" 3.5mm








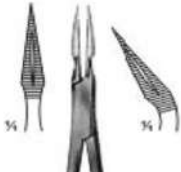




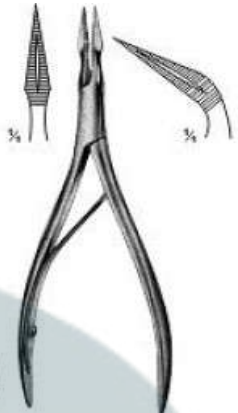
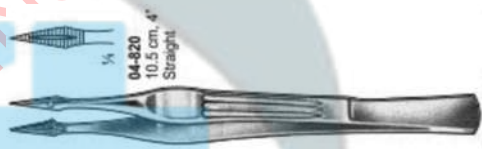

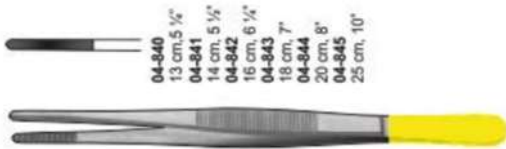
- 04-700
16 cm, 6 1/2"
- 04-701
20 cm, 8"
- 04-702
24 cm, 9 1/2"
- 04-703
30 cm, 12"








04-711
10.5cm, 4"






798	37	HMI-GS-791	KUEHNE 10.5cm, 4"	
799	37	HMI-GS-792	FEILCHENFELD 7.5 cm, 3" Straight	 <p>04-720 7.5 cm, 3" 04-721 9 cm, 3 1/2" 04-722 11 cm, 4" Straight</p>
800	37	HMI-GS-793	FEILCHENFELD 9 cm, 3 1/2" Straight	
801	37	HMI-GS-794	FEILCHENFELD 11 cm, 4" Straight	
802	37	HMI-GS-795	HUNTER 10.5 cm, 4" Straight	
803	37	HMI-GS-796	HUNTER 10.5 cm, 4" Curved	
804	37	HMI-GS-797	STIEGLITZ FORCEPS 12.5 cm, 5"	
805	38	HMI-GS-798	Jewelers Forceps	













806	38	HMI-GS-799	Jewelers Forceps	
807	38	HMI-GS-800	Jewelers Forceps	
808	38	HMI-GS-801	Jewelers Forceps	
809	38	HMI-GS-802	Jewelers Forceps	
810	38	HMI-GS-803	Jewelers Forceps	
811	38	HMI-GS-804	Jewelers Forceps	
812	38	HMI-GS-805	Jewelers Forceps	
813	38	HMI-GS-806	STIEGLITZ 14 cm, 5 1/2" Str.	











814	38	HMI-GS-807	STIEGLITZ 14 cm, 5 ½" Cvd.	
815	38	HMI-GS-808	PEET 11.5 cm, 4 ½"	
816	38	HMI-GS-809	RALK 15 cm, 6" Str.	
817	38	HMI-GS-810	RALK 15 cm, 6" Cvd.	
818	38	HMI-GS-811	CARMALT 10.5 cm, 4" Straight	
819	38	HMI-GS-812	CARMALT 10.5 cm, 4" Curved	
820	39	HMI-GS-813	STANDARD 13 cm, 5 ¼"	
821	39	HMI-GS-814	STANDARD 14 cm, 5 ½"	
822	39	HMI-GS-815	STANDARD 16 cm, 6 ¼"	
823	39	HMI-GS-816	STANDARD 18 cm, 7"	
824	39	HMI-GS-817	STANDARD 20 cm, 8"	
825	39	HMI-GS-818	STANDARD 25 cm, 10"	

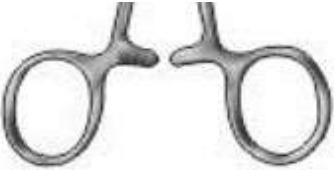
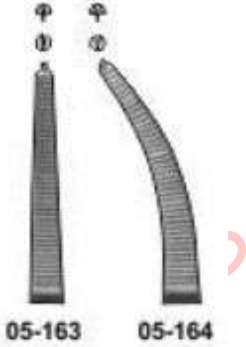



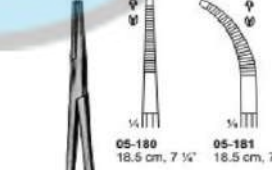

826	39	HMI-GS-819	STANDARD 14 cm, 5 1/2"	
827	39	HMI-GS-820	STANDARD 16 cm, 6 1/4"	
828	39	HMI-GS-821	STANDARD 18 cm, 7"	
829	39	HMI-GS-822	STANDARD 20 cm, 8"	
830	39	HMI-GS-823	STANDARD 25 cm, 20"	
831	39	HMI-GS-824	STANDARD 30 cm, 12"	
832	39	HMI-GS-825	ADSON 12 cm, 5" cross serration	
833	39	HMI-GS-826	ADSON 12 cm, 5" cross serration-1:2 Teeth	
834	39	HMI-GS-827	ADSON 15.0 cm, 6" cross serration-1:2 Teeth	
835	39	HMI-GS-828	ADSON 12 cm, 5" Dressing, cross serration	
836	39	HMI-GS-829	ADSON 12 cm, 5" Tissue, cross serration-1:2 Teeth	
837	39	HMI-GS-830	ADSON 12 cm, 5"	
838	39	HMI-GS-831	WANGENSTEEN TISSUE FORCEPS 15.2 cm, 6"	
839	39	HMI-GS-832	WANGENSTEEN TISSUE FORCEPS 22.9 cm, 9"	

840	39	HMI-GS-833	WANGENSTEEN TISSUE FORCEPS 25.4 cm, 10"	
841	39	HMI-GS-834	WANGENSTEEN 15 cm, 6"	
842	39	HMI-GS-835	WANGENSTEEN 23 cm, 9"	
843	39	HMI-GS-836	WANGENSTEEN 25 cm, 10"	
844	39	HMI-GS-837	BONNEY DISSECTING 18 cm Straight X-Serrations 1:2 Teeth	
845	39	HMI-GS-838	BONNEY DISSECTING 18 cm Straight, Serrated 1:2 Teeth	
846	39	HMI-GS-839	BONNEY DISSECTING 18 cm Straight, Serrated 2:3 Teeth	
847	39	HMI-GS-840	POTTS-SMITH FORCEPS 15 cm, 6"	



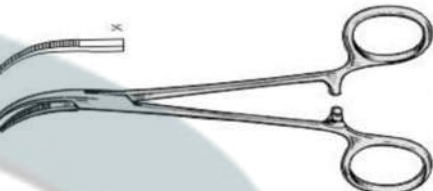

848	39	HMI-GS-841	POTTS-SMITH FORCEPS 18 cm, 7"	
849	39	HMI-GS-842	POTTS-SMITH FORCEPS 20 cm, 8"	
850	39	HMI-GS-843	POTTS-SMITH FORCEPS 23 cm, 9"	
851	39	HMI-GS-844	POTTS-SMITH FORCEPS 25 cm, 10"	
852	HAEMOSTATIC FORCEPS			
853				
854	40	HMI-GS-845	CARREL 8.5 cm, 3 1/4"	
855	40	HMI-GS-846	BABY-MOSQUITO (HARTMANN) 10.0 cm, 4"	
856	40	HMI-GS-847	BABY-MOSQUITO (HARTMANN) 10.0 cm, 4"	
857	40	HMI-GS-848	BABY-MOSQUITO (HARTMANN) 10.0 cm, 4"	

858	40	HMI-GS-849	BABY-MOSQUITO (HARTMANN) 10.0 cm, 4"	 05-113
859	40	HMI-GS-850	BABY-MOSQUITO (HARTMANN) 10.0 cm, 4"	 05-114
860	40	HMI-GS-851	MICRO-HALSTED 12.5 cm, 5"	
861	40	HMI-GS-852	MICRO-HALSTED 12.5 cm, 5"	 05-121
862	40	HMI-GS-853	MICRO-HALSTED 12.5 cm, 5"	 05-122
863	40	HMI-GS-854	MICRO-HALSTED 12.5 cm, 5"	 05-123
864	40	HMI-GS-855	MICRO-HALSTED 12.5 cm, 5"	 05-124
865	40	HMI-GS-856	HALSTED-MOSQUITO 12.5 cm, 5"	  05-131  05-132  05-133  05-134
866	40	HMI-GS-857	HALSTED-MOSQUITO 12.5 cm, 5"	
867	40	HMI-GS-858	HALSTED-MOSQUITO 12.5 cm, 5"	
868	40	HMI-GS-859	HALSTED-MOSQUITO 12.5 cm, 5"	

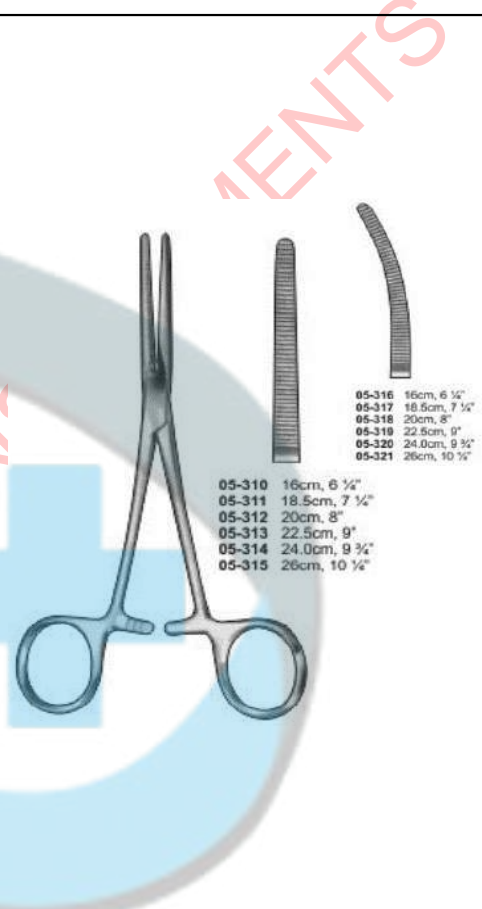
869	40	HMI-GS-860	HALSTED-MOSQUITO 12.5 cm, 5"	
870	40	HMI-GS-861	PROVIDENCE-HOSPITAL 14.0 cm, 5 1/2"	  05-141  05-142
871	40	HMI-GS-862	PROVIDENCE-HOSPITAL 14.0 cm, 5 1/2"	
872	40	HMI-GS-863	PROVIDENCE-HOSPITAL 14.0 cm, 5 1/2"	
873	40	HMI-GS-864	KELLY 14.0 cm, 5 1/2"	
874	40	HMI-GS-865	KELLY 14.0 cm, 5 1/2"	  05-151  05-152
875	40	HMI-GS-866	KELLY 14.0 cm, 5 1/2"	
876	41	HMI-GS-867	CRILE 14.0 cm, 5 1/2"	  05-161  05-162
877	41	HMI-GS-868	CRILE 14.0 cm, 5 1/2"	


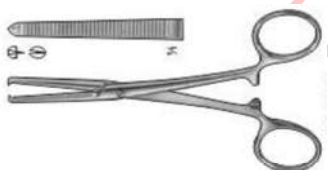
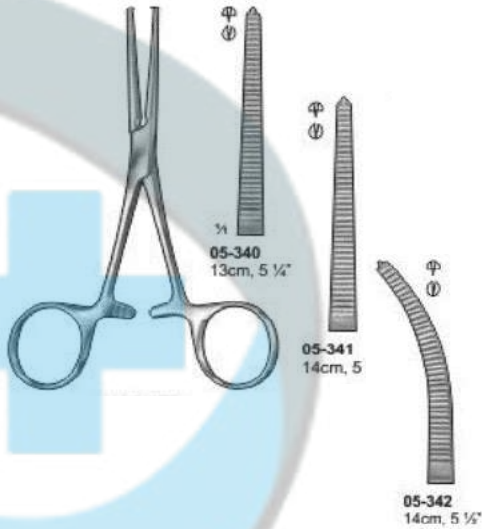

878	41	HMI-GS-869	CRILE 14.0 cm, 5 1/2"	
879	41	HMI-GS-870	CRILE 14.0 cm, 5 1/2"	
880	41	HMI-GS-871	CRILE 14.0 cm, 5 1/2"	
881	41	HMI-GS-872	ADSON 18.5 cm, 7 1/4"	
882	41	HMI-GS-873	ADSON 18.5 cm, 7 1/4"	
883	41	HMI-GS-874	ADSON 18.5 cm, 7 1/4"	
884	41	HMI-GS-875	ADSON 1:2 18.5 cm, 7 1/4"	
885	41	HMI-GS-876	ADSON 1:2 18.5 cm, 7 1/4"	

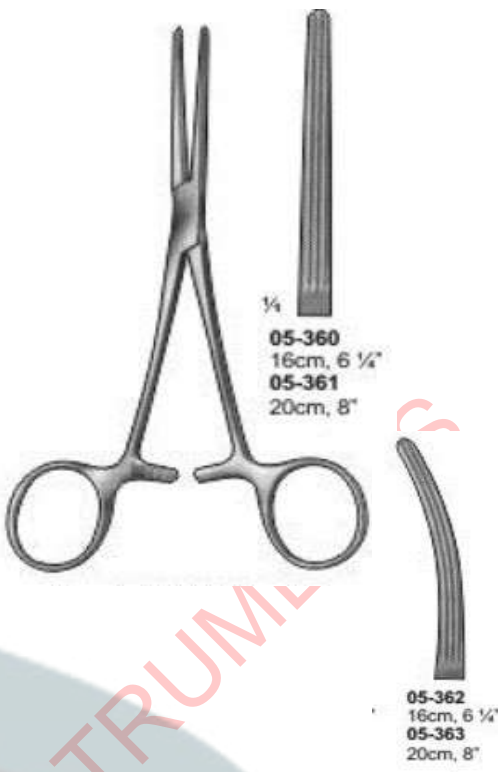
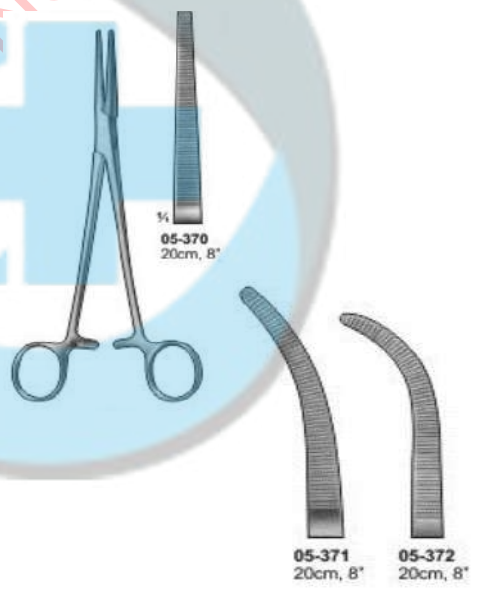
886	41	HMI-GS-877	RANKIN 16.0 cm, 6 ¼"	
887	41	HMI-GS-878	RANKIN 16.0 cm, 6 ¼"	
888	41	HMI-GS-879	RANKIN 16.0 cm, 6 ¼"	
889	41	HMI-GS-880	RANKIN 16.0 cm	
890	41	HMI-GS-881	RANKIN 16.0 cm	
891	41	HMI-GS-882	RANKIN 16.0 cm	
892	41	HMI-GS-883	RANKIN 16.0 cm	
893	41	HMI-GS-884	RANKIN 16.0 cm	


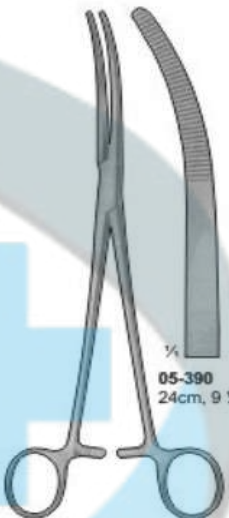
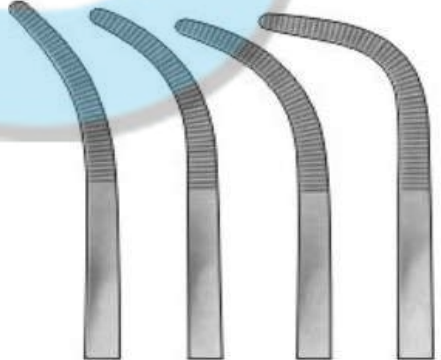
894	41	HMI-GS-885	GREY TURNER 14.5 cm, 5 3/4" Straight Joint.	 <p>05-210 14.5 cm, 5 3/4" 05-211 18 cm, 7" Straight Joint.</p>
895	41	HMI-GS-886	GREY TURNER 18 cm, 7" Straight Joint.	
896	42	HMI-GS-887	CAIRNS 14.5 cm, 5 3/4" Straight, box joint, as above but curved on flat.	
897	42	HMI-GS-888	CAIRNS 14.5 cm, 5 3/4" curved laterally, joint	
898	42	HMI-GS-889	SPENCER-WELLS Slender Type 13.0 cm	 <p>05-240 13.0 cm 05-241 15.0 cm 05-242 17.5 cm 05-243 20 cm 05-244 13.0 cm 05-245 15.0 cm 05-246 17.5 cm 05-247 20 cm</p>
899	42	HMI-GS-890	SPENCER-WELLS Slender Type 15.0 cm	
900	42	HMI-GS-891	SPENCER-WELLS Slender Type 17.5 cm	
901	42	HMI-GS-892	SPENCER-WELLS Slender Type 20 cm	
902	42	HMI-GS-893	SPENCER-WELLS Slender Type 13.0 cm	
903	42	HMI-GS-894	SPENCER-WELLS Slender Type 15.0 cm	
904	42	HMI-GS-895	SPENCER-WELLS Slender Type 17.5 cm	
905	42	HMI-GS-896	SPENCER-WELLS Slender Type 20 cm	
906	42	HMI-GS-897	PEAN 24cm, 9 3/4"	
907	42	HMI-GS-898	PEAN 26cm, 10 1/4"	
908	42	HMI-GS-899	PEAN 28cm, 11"	
909	42	HMI-GS-900	PEAN 24cm, 9 3/4"	

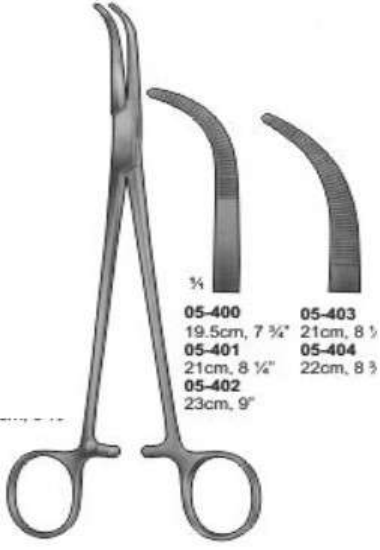


910	42	HMI-GS-901	PEAN 26cm, 10 1/4"
911	42	HMI-GS-902	PEAN 28cm, 11"
912	42	HMI-GS-903	PEAN Slender Type 13.0 cm
913	42	HMI-GS-904	PEAN Slender Type 14.0 cm
914	42	HMI-GS-905	PEAN Slender Type 13.0 cm
915	42	HMI-GS-906	PEAN Slender Type 14.0 cm
916	43	HMI-GS-907	ROCHESTER-PEAN 16cm, 6 1/4"
917	43	HMI-GS-908	ROCHESTER-PEAN 18.5cm, 7 1/4"
918	43	HMI-GS-909	ROCHESTER-PEAN 20cm, 8"
919	43	HMI-GS-910	ROCHESTER-PEAN 22.5cm, 9"
920	43	HMI-GS-911	ROCHESTER-PEAN 24.0cm, 9 3/4"
921	43	HMI-GS-912	ROCHESTER-PEAN 26cm, 10 1/4"
922	43	HMI-GS-913	ROCHESTER-PEAN 16cm, 6 1/4"
923	43	HMI-GS-914	ROCHESTER-PEAN 18.5cm, 7 1/4"
924	43	HMI-GS-915	ROCHESTER-PEAN 20cm, 8"
925	43	HMI-GS-916	ROCHESTER-PEAN 22.5cm, 9"
926	43	HMI-GS-917	ROCHESTER-PEAN 24.0cm, 9 3/4"
927	43	HMI-GS-918	ROCHESTER-PEAN 26cm, 10 1/4"
928	43	HMI-GS-919	KOCHER-OCHSNER 16cm, 6 1/4"
929	43	HMI-GS-920	KOCHER-OCHSNER 18.5cm, 7 1/4"
930	43	HMI-GS-921	KOCHER-OCHSNER 20cm, 8"
931	43	HMI-GS-922	KOCHER-OCHSNER 22.5cm, 9"
932	43	HMI-GS-923	KOCHER-OCHSNER 24.0cm, 9 3/4"
933	43	HMI-GS-924	KOCHER-OCHSNER 26cm, 10 1/4"








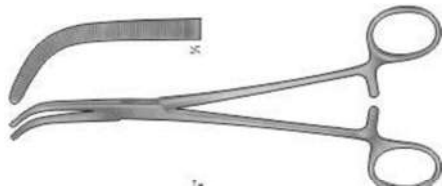
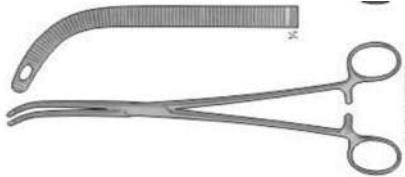



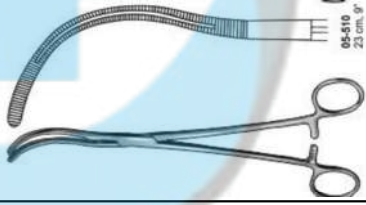


934	43	HMI-GS-925	KOCHER-OCHSNER 16cm, 6 1/4"	 <p>05-291 18.5cm, 7 1/4" 05-292 20cm, 8" 05-293 22.5cm, 9" 05-294 24.0cm, 9 3/4" 05-295 26cm, 10 1/4"</p>
935	43	HMI-GS-926	KOCHER-OCHSNER 18.5cm, 7 1/4"	
936	43	HMI-GS-927	KOCHER-OCHSNER 20cm, 8"	
937	43	HMI-GS-928	KOCHER-OCHSNER 22.5cm, 9"	
938	43	HMI-GS-929	KOCHER-OCHSNER 24.0cm, 9 3/4"	
939	43	HMI-GS-930	KOCHER-OCHSNER 26cm, 10 1/4"	
940	43	HMI-GS-931	KOCHER Strong Pattern 14.5cm, 5 3/4"	
941	43	HMI-GS-932	KOCHER 13cm, 5 1/4"	 <p>05-340 13cm, 5 1/4" 05-341 14cm, 5" 05-342 14cm, 5 1/2"</p>
942	43	HMI-GS-933	KOCHER 14cm, 5 1/2"	
943	43	HMI-GS-934	KOCHER 14cm, 5 1/2"	
944	43	HMI-GS-935	ROCHESTER-OCHSNER 14cm, 5 1/2"	
945	43	HMI-GS-936	ROCHESTER-OCHSNER 14cm, 5 1/2"	 <p>05-350 14cm, 5 1/2" 05-351 14cm, 5 1/2"</p>

946	44	HMI-GS-937	ROCHESTER-CARMALT 16cm, 6 1/4"	 <p> 05-360 16cm, 6 1/4" 05-361 20cm, 8" 05-362 16cm, 6 1/4" 05-363 20cm, 8" </p>
947	44	HMI-GS-938	ROCHESTER-CARMALT 20cm, 8"	
948	44	HMI-GS-939	ROCHESTER-CARMALT 16cm, 6 1/4"	
949	44	HMI-GS-940	ROCHESTER-CARMALT 20cm, 8"	
950	44	HMI-GS-941	HEISS 20cm, 8"	 <p> 05-370 20cm, 8" 05-371 20cm, 8" 05-372 20cm, 8" </p>
951	44	HMI-GS-942	HEISS 20cm, 8"	
952	44	HMI-GS-943	HEISS 20cm, 8"	
953	44	HMI-GS-944	BAINBRIDGE 15 cm, 5 3/4"	

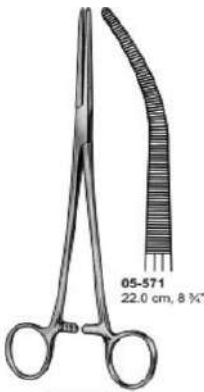
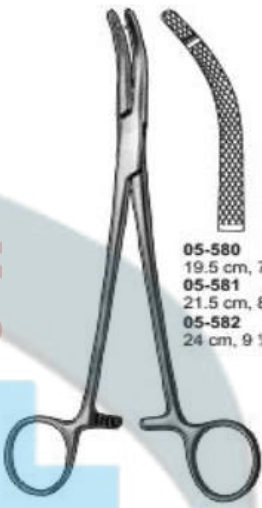

954	44	HMI-GS-945	BAINBRIDGE 18.5 cm, 7 ¼"	 <p>05-382 15 cm, 5 ¾" 05-383 18.5 cm, 7 ¼"</p>
955	44	HMI-GS-946	BAINBRIDGE 15 cm, 5 ¾"	
956	44	HMI-GS-947	BAINBRIDGE 18.5 cm, 7 ¼"	
957	44	HMI-GS-948	RUMEL 24cm, 9 ½"	 <p>05-390 24cm, 9 ½"</p>  <p>05-391 05-392 05-393 05-394 24cm, 9 ½" 24cm, 9 ½" 24cm, 9 ½" 24cm, 9 ½"</p>
958	44	HMI-GS-949	RUMEL 24cm, 9 ½"	
959	44	HMI-GS-950	RUMEL 24cm, 9 ½"	
960	44	HMI-GS-951	RUMEL 24cm, 9 ½"	
961	44	HMI-GS-952	RUMEL 24cm, 9 ½"	









962	44	HMI-GS-953	OVERHOLT-GEISSENDOERFER 19.5cm, 7 3/4"	 <p> 05-400 19.5cm, 7 3/4" 05-401 21cm, 8 1/4" 05-402 23cm, 9" 05-403 21cm, 8 1/4" 05-404 22cm, 8 3/4" </p>
963	44	HMI-GS-954	OVERHOLT-GEISSENDOERFER 21cm, 8 1/4"	
964	44	HMI-GS-955	OVERHOLT-GEISSENDOERFER 23cm, 9"	
965	44	HMI-GS-956	OVERHOLT-GEISSENDOERFER 21cm, 8 1/4"	
966	44	HMI-GS-957	OVERHOLT-GEISSENDOERFER 22cm, 8 3/4"	
967	44	HMI-GS-958	OVERHOLT-GEISSENDOERFER 22.5cm, 9"	
968	44	HMI-GS-959	OVERHOLT-GEISSENDOERFER 22.5cm, 9"	 <p> 05-405 22.5cm, 9" 05-406 22.5cm, 9" 05-407 26cm, 10 1/4" 05-408 27cm, 10 3/4" 05-409 27.5cm, 10 3/4" 05-410 27cm, 10 3/4" 05-411 </p>
969	44	HMI-GS-960	OVERHOLT-GEISSENDOERFER 26cm, 10 1/4"	
970	44	HMI-GS-961	OVERHOLT-GEISSENDOERFER 27cm, 10 3/4"	
971	44	HMI-GS-962	OVERHOLT-GEISSENDOERFER 27.5cm, 10 3/4"	
972	44	HMI-GS-963	OVERHOLT-GEISSENDOERFER 27cm, 10 3/4"	


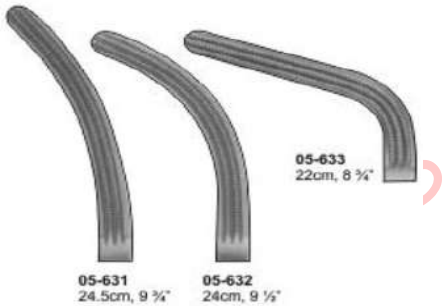
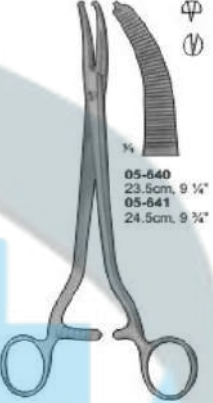
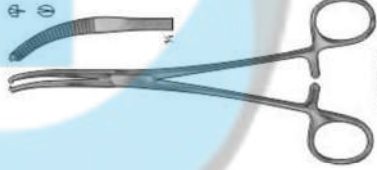

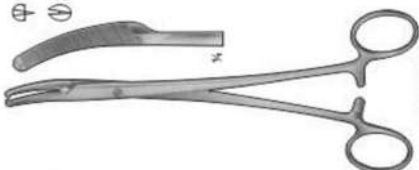
973	44	HMI-GS-964	OVERHOLT-GEISSENDOERFER 28cm, 11	28cm, 11
974	45	HMI-GS-965	MIXTER 23cm, 9"	
975	45	HMI-GS-966	LOWER 18cm, 7"	
976	45	HMI-GS-967	LAHEY (SWEET) 19cm, 1/2"	 1/4 05-440 19cm, 3/4" 05-441 22cm, 8 3/4"
977	45	HMI-GS-968	LAHEY (SWEET) 22cm, 8 3/4"	
978	45	HMI-GS-969	MIXTER 22cm, 8 3/4"	 1/4 05-450 22cm, 8 3/4" 05-451 25cm, 10"
979	45	HMI-GS-970	MIXTER 25cm, 10"	
980	45	HMI-GS-971	DESJARDINS 22cm, 8 3/4"	 1/4 05-460 22cm, 8 3/4"




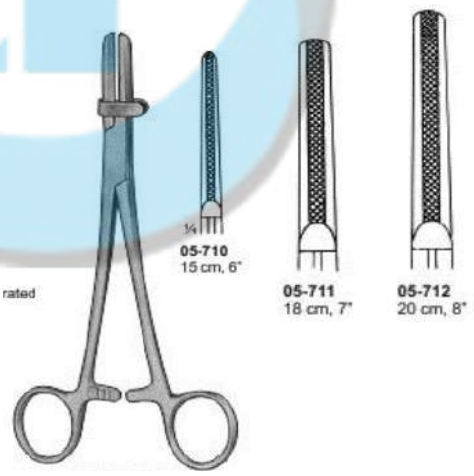
981	45	HMI-GS-972	MIXTER-O'SHAUGNESSY 19cm, 7 1/2"	
982	45	HMI-GS-973	FINOCHIETTO 24.5cm, 9 1/2"	
983	45	HMI-GS-974	CRAFOORD 24.5cm, 9 3/4"	
984	46	HMI-GS-975	BABY-MIXTER 14.0 cm	
985	46	HMI-GS-976	BABY-MIXTER 18.0 cm	
986	46	HMI-GS-977	STILLE 23 cm, 9"	
987	46	HMI-GS-978	MAYO-GUYON 23 cm, 9"	
988	46	HMI-GS-979	MAYO-GUYON 24 cm, 9 1/2"	







989	46	HMI-GS-980	GUYON 23 cm, 9"	
990	46	HMI-GS-981	GRAY 22 cm, 8 1/2"	
991	46	HMI-GS-982	GRAY 23 cm, 9"	
992	46	HMI-GS-983	GRAY 22 cm, 8 1/2"	
993	46	HMI-GS-984	GRAY 23 cm, 9"	
994	46	HMI-GS-985	PHANEUF 1:2 21.5 cm, 8 1/2"	
995	46	HMI-GS-986	PHANEUF 1:2 21.5 cm, 8 1/2"	
996	46	HMI-GS-987	DEAN-SHALLCROSS 18 cm, 7" S Curve, Coarse serration	





997	46	HMI-GS-988	ROBERTS 22.0 cm, 8 3/4"	 <p>05-571 22.0 cm, 8 3/4"</p>
998	46	HMI-GS-989	ROBERTS 22.0 cm, 8 3/4"	
999	47	HMI-GS-990	HEANEY 19.5 cm, 7 1/2"	 <p>05-580 19.5 cm, 7 1/2" 05-581 21.5 cm, 8 1/2" 05-582 24 cm, 9 1/2"</p>
1000	47	HMI-GS-991	HEANEY 21.5 cm, 8 1/2"	
1001	47	HMI-GS-992	HEANEY 24 cm, 9 1/2"	
1002	47	HMI-GS-993	HEANEY 19.5 cm, 7 1/2"	
1003	47	HMI-GS-994	HEANEY 21.5 cm, 8 1/2"	 <p>05-583 1 1/2" 19.5 cm, 7 1/2" 05-584 1 1/2" 21.5 cm, 8 1/2" 05-585 1 1/2" 24 cm, 9 1/2"</p>
1004	47	HMI-GS-995	HEANEY 24 cm, 9 1/2"	


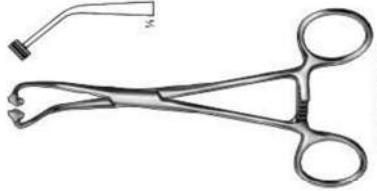


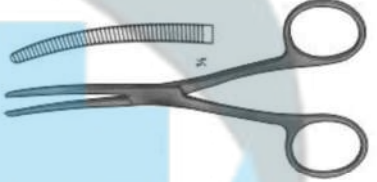

1005	47	HMI-GS-996	MOYNIHAN 23cm, 9"	 <p> <small>3/4</small> 05-590 23cm, 9" 05-591 24cm, 9 3/4" </p>
1006	47	HMI-GS-997	MOYNIHAN 24cm, 9 3/4"	
1007	47	HMI-GS-998	NEGUS 19.5cm, 7 3/4"	 <p> <small>3/4</small> 05-600 19.5cm, 7 3/4" </p>
1008	47	HMI-GS-999	NEGUS 19.5cm, 7 3/4"	 <p> 05-601 1, 7 3/4" 19.5cm, 7 3/4" </p>
1009	47	HMI-GS-1000	WERTHEIM-CULLEN 60mm 23cm, 9"	
1010	47	HMI-GS-1001	WERTHEIM-CULLEN 80mm 23cm, 9"	
1011	47	HMI-GS-1002	WERTHEIM 25cm, 10"	
1012	47	HMI-GS-1003	WERTHEIM Parametrium Clamps 25cm, 10"	

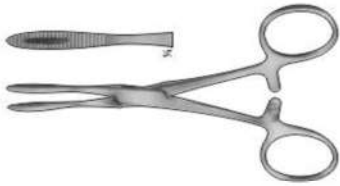
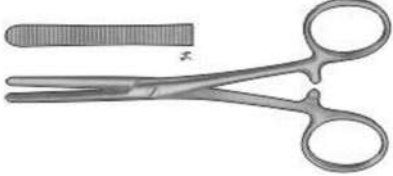

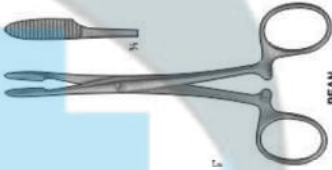
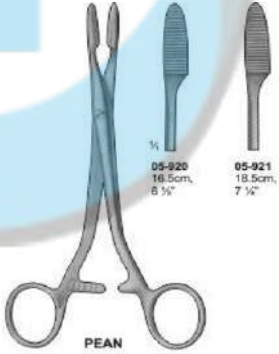

1013	47	HMI-GS-1004	WERTHEIM Parametrium Clamps 24.5cm, 9 3/4"	
1014	47	HMI-GS-1005	WERTHEIM Parametrium Clamps 24cm, 9 1/2"	
1015	47	HMI-GS-1006	WERTHEIM Parametrium Clamps 22cm, 8 3/4"	
1016	47	HMI-GS-1007	WERTHEIM 23.5cm, 9 1/4"	
1017	47	HMI-GS-1008	WERTHEIM 24.5cm, 9 3/4"	
1018	48	HMI-GS-1009	MIKULICZ 18.5cm, 7 1/4"	
1019	48	HMI-GS-1010	MIKULICZ 20.5cm, 8"	
1020	48	HMI-GS-1011	MIKULICZ 20cm, 8"	

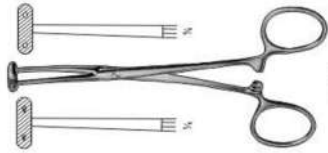


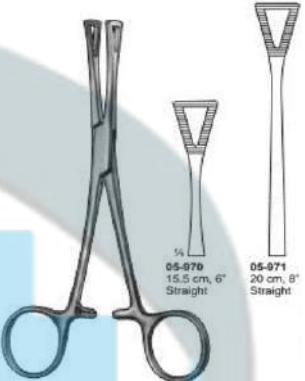
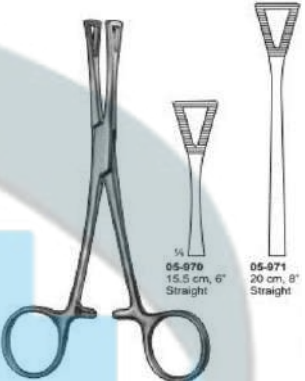



1021	48	HMI-GS-1012	MIKULICZ 20.5cm, 8"	
1022	48	HMI-GS-1013	PRESBYTERIAN 16.5 cm, 6 1/2" Straight, Smooth	 05-690 16.5 cm, 6 1/2" 05-691 18 cm, 7" Straight, Smooth
1023	48	HMI-GS-1014	PRESBYTERIAN 18 cm, 7" Straight, Smooth	
1024	48	HMI-GS-1015	TUBING 18 cm, 7" Cross Serrated	 05-700 18 cm, 7" 05-701 20 cm, 8" Cross Serrated
1025	48	HMI-GS-1016	TUBING 20 cm, 8" Cross Serrated	
1026	48	HMI-GS-1017	TUBING CLUMP with Protector, Cross Serrated 15 cm, 6"	 05-710 15 cm, 6" 05-711 18 cm, 7" 05-712 20 cm, 8"
1027	48	HMI-GS-1018	TUBING CLUMP with Protector, Cross Serrated 18 cm, 7"	
1028	48	HMI-GS-1019	TUBING CLUMP with Protector, Cross Serrated 20 cm, 8"	

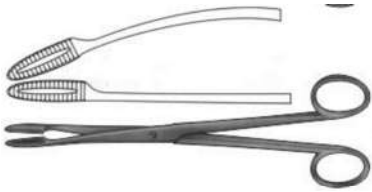
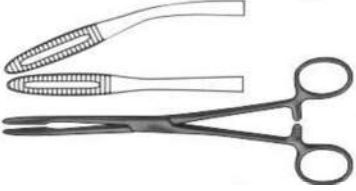
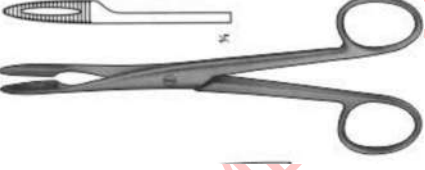
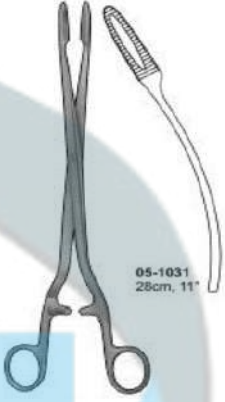
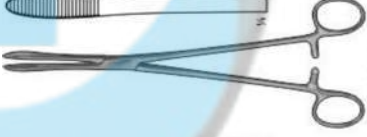
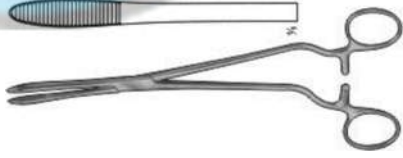
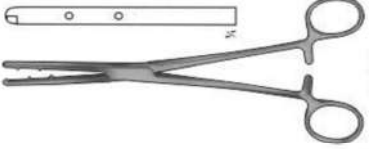
1029	49	HMI-GS-1020	JONES / PERFORATING 9 cm, 3 1/2" Slight Curve	
1030	49	HMI-GS-1021	ENGL. MODELL 9 cm, 3 1/2"	
1031	49	HMI-GS-1022	SCHAEDEL 9 cm, 3 1/2"	
1032	49	HMI-GS-1023	DOYEN 18 cm, 7"	
1033	49	HMI-GS-1024	BACKHAUS 8 cm, 3" Curved	
1034	49	HMI-GS-1025	BACKHAUS 11 cm, 4 1/2" Curved	
1035	49	HMI-GS-1026	BACKHAUS 13 cm, 5" Curved	
1036	49	HMI-GS-1027	BACKHAUS 15 cm, 5 3/4" Curved	
1037	49	HMI-GS-1028	ROEDER 13 cm, 5" Curved, Serrated	
1038	49	HMI-GS-1029	ROEDER 15 cm, 6" Curved, Serrated	


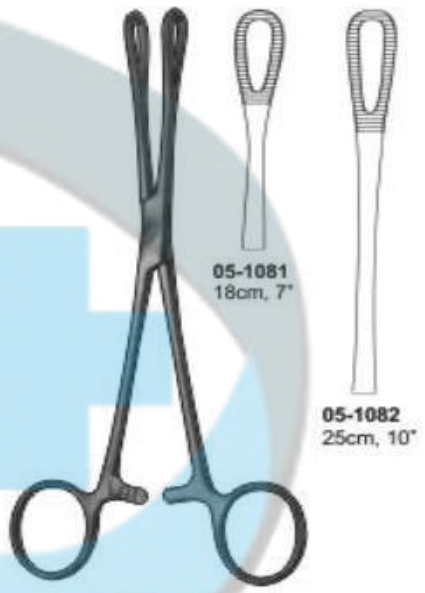
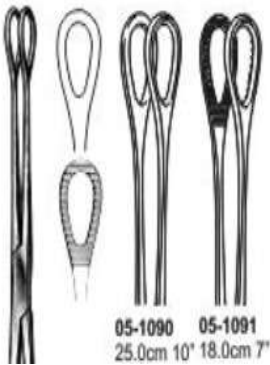
1039	49	HMI-GS-1030	NON-PERFORATING 11 cm, 4 ½"	
1040	49	HMI-GS-1031	NON-PERFORATING 13 cm, 5"	
1041	50	HMI-GS-1032	LORNA 10 cm, 4"	
1042	50	HMI-GS-1033	LORNA 11 cm, 4 ½"	
1043	50	HMI-GS-1034	LORNA 13 cm, 5"	
1044	50	HMI-GS-1035	BACKHAUS CLIP 11 cm, 4 ½" with clip for tubing or cable	
1045	50	HMI-GS-1036	BALL & SOCKET 13 cm, 5" Non-perforating	
1046	50	HMI-GS-1037	TOHOKU 10cm, 4" Non-Perforating	

1047	50	HMI-GS-1038	TOHOKU 13cm, 5" Non-Perforating	
1048	50	HMI-GS-1039	PEERS-BERTMAN 14.5 cm, 5 3/4" Serrated	
1049	50	HMI-GS-1040	BERNHARD 16.5 cm, 6 1/2"	
1050	51	HMI-GS-1041	FRICKE Artery Forceps 13cm, 5 1/4"	
1051	51	HMI-GS-1042	BRYANT 13cm, 5 1/4"	
1052	51	HMI-GS-1043	LISTER Sinus Forceps 13cm 5 1/4"	 <p>05-870 05-871 05-872 13cm 15.5cm 17.5cm 5 1/4" 6" 7"</p>
1053	51	HMI-GS-1044	LISTER Sinus Forceps 15.5cm 6"	
1054	51	HMI-GS-1045	LISTER Sinus Forceps 17.5cm 7"	

1055	51	HMI-GS-1046	KRONLENIN 13cm, 5 ¼"	
1056	51	HMI-GS-1047	PEAN 12.5cm, 4 ¾"	
1057	51	HMI-GS-1048	PEAN 12.5cm, 4 ¾"	
1058	51	HMI-GS-1049	PEAN 14cm, 5 ½"	
1059	51	HMI-GS-1050	PEAN	
1060	51	HMI-GS-1051	PEAN 16.5cm, 6 ½"	
1061	51	HMI-GS-1052	PEAN 18.5cm, 7 ¼"	
1062	52	HMI-GS-1053	TUFFIER 13.0 cm, 5"	

1063	52	HMI-GS-1054	MARTEL 14.0 cm, 5 ½"	
1064	52	HMI-GS-1055	WILLET-MARTEL 19.0 cm, 7 ½"	
1065	52	HMI-GS-1056	PRATT 15 cm, 4 ¾" Slight Curve	
1066	52	HMI-GS-1057	PENNINGTON / SIEZING 15.5 cm, 6" Straight	
1067	52	HMI-GS-1058	PENNINGTON / SIEZING 20 cm, 8" Straight	
1068	52	HMI-GS-1059	CHAPUT 13.0 cm, 5"	
1069	53	HMI-GS-1060	GROSS 18cm, 7" With Ratchet	
1070	53	HMI-GS-1061	GROSS 20cm, 8" With Ratchet	

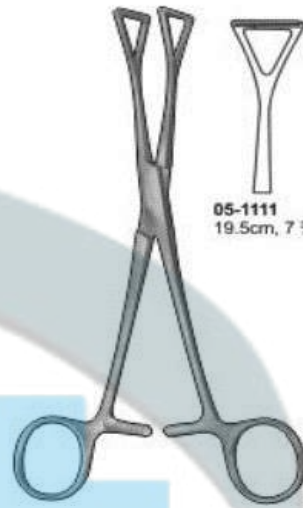
1071	53	HMI-GS-1062	GROSS Without Ratchet 20cm, 8"	
1072	53	HMI-GS-1063	GROSS With Ratchet 20cm, 8"	
1073	53	HMI-GS-1064	With Ratchet 14.5cm, 5 3/4"	
1074	53	HMI-GS-1065	SIMS-MAIER 28cm, 11"	
1075	53	HMI-GS-1066	SIMS-MAIER 28cm, 11"	
1076	53	HMI-GS-1067	COLLIN 24cm, 9 1/2"	
1077	53	HMI-GS-1068	CHERON Handles Laterally Angled 24cm, 9 1/2"	
1078	53	HMI-GS-1069	EMMET 21cm, 8 1/4"	

1079	54	HMI-GS-1070	FOERSTER-BALLENGER 18cm, 7"	
1080	54	HMI-GS-1071	FOERSTER-BALLENGER 18cm, 7"	
1081	54	HMI-GS-1072	FOERSTER-BALLENGER 18cm, 7"	
1082	54	HMI-GS-1073	RAMPLEY	
1083	54	HMI-GS-1074	RAMPLEY 18cm, 7"	
1084	54	HMI-GS-1075	RAMPLEY 25cm, 10"	
1085	54	HMI-GS-1076	FOERSTER 25.0cm 10" Round	
1086	54	HMI-GS-1077	FOERSTER 18.0cm 7" Round	
1087	54	HMI-GS-1078	FOERSTER 20.0cm 8" Round	
1088	54	HMI-GS-1079	FOERSTER 25.0cm 10" Round	

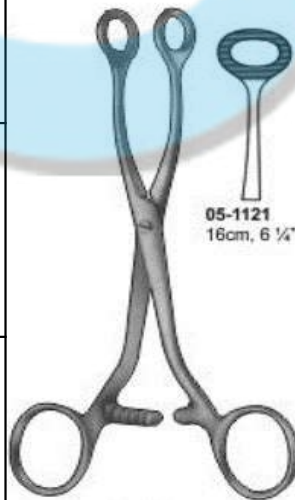
1089	54	HMI-GS-1080	FOERSTER 25.0cm 10" Round
1090	54	HMI-GS-1081	FOERSTER 18.0cm 7" Round
1091	54	HMI-GS-1082	FOERSTER 20.0cm 8" Round
1092	54	HMI-GS-1083	FOERSTER 25.0cm 10" Round
1093	54	HMI-GS-1084	COLLIN
1094	54	HMI-GS-1085	COLLIN 19.5cm, 7 3/4"
1095	54	HMI-GS-1086	COLLIN 23cm, 9"
1096	54	HMI-GS-1087	COLLIN
1097	54	HMI-GS-1088	COLLIN 16cm, 6 1/4"
1098	54	HMI-GS-1089	COLLIN 16cm, 6 1/4"



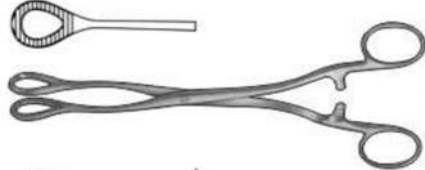
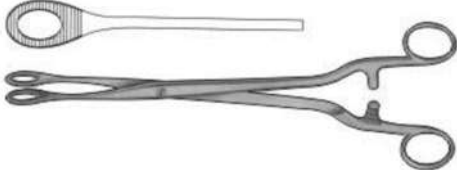
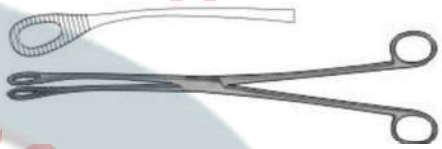
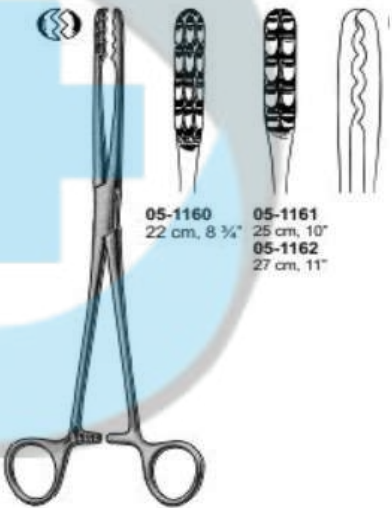
Round
05-109*
 20.0cm
05-109
 25.0cm
 Round
 05-1094
 25.0cm 10"
 Round
 05-1095
 18.0cm 7"
 05-1096
 20.0cm 8"
 05-1097
 25.0cm 10"
 Round



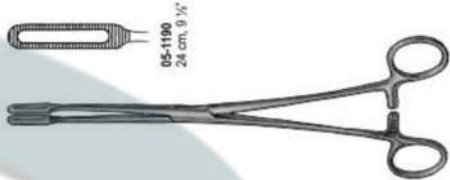
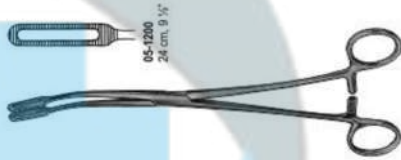














05-1111
 19.5cm, 7 3/4"
05-1112
 23cm, 9"















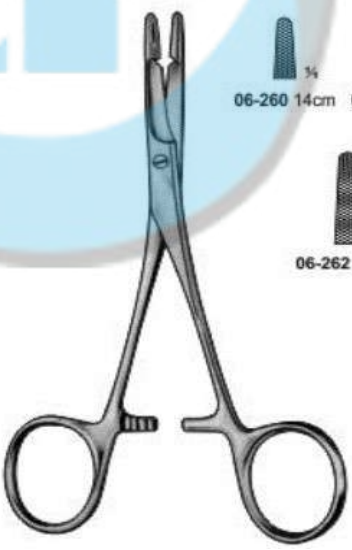
05-1121
 16cm, 6 1/4"
05-1122
 16cm, 6 1/4"
05-1123
 17cm, 6 3/4"

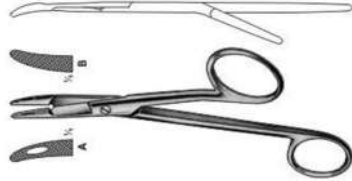


1099	54	HMI-GS-1090	COLLIN 17cm, 6 ¾"	
1100	54	HMI-GS-1091	HEYWOOD-SMITH 20cm, 8"	
1101	55	HMI-GS-1092	NOTO 28cm, 11"	
1102	55	HMI-GS-1093	KELLY 32cm, 12 ½"	
1103	55	HMI-GS-1094	ULRICH 22 cm, 8 ¾"	 <p>05-1160 22 cm, 8 ¾"</p> <p>05-1161 25 cm, 10"</p> <p>05-1162 27 cm, 11"</p>
1104	55	HMI-GS-1095	ULRICH 25 cm, 10"	
1105	55	HMI-GS-1096	ULRICH 27 cm, 11"	
1106	55	HMI-GS-1097	ULRICH 22 cm, 8 ¾"	



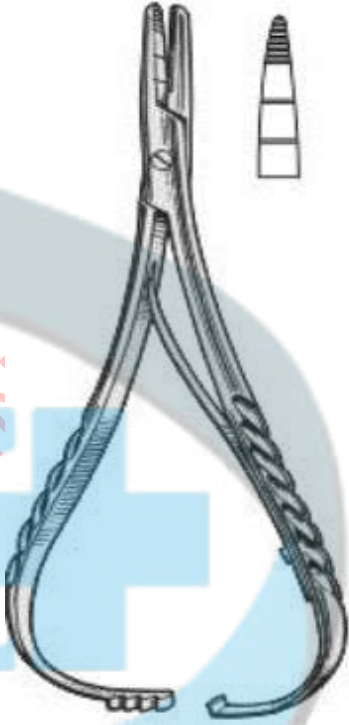
1107	55	HMI-GS-1098	ULRICH 25 cm, 10"	 <p>05-1170 22 cm, 8 1/2" 05-1171 25 cm, 10" 05-1172 27 cm, 11"</p>
1108	55	HMI-GS-1099	ULRICH 27 cm, 11"	
1109	55	HMI-GS-1100	HEYWOOD SMITH 25 cm, 10"	
1110	55	HMI-GS-1101	FLETCHER 24 cm, 9 1/2"	 <p>05-1190 24 cm, 9 1/2"</p>
1111	55	HMI-GS-1102	FLETCHER 24 cm, 9 1/2"	 <p>05-1200 24 cm, 9 1/2"</p>
1112				NEEDLE HOLDERS
1113				
1114	56	HMI-GS-1103	DERF Needle Holder 12 cm, 5"	 <p>A 3/4" B 1/2"</p>
1115	56	HMI-GS-1104	DERF Needle Holder 12 cm, 5"	
1116	56	HMI-GS-1105	COLLIER Needle Holder 12.5 cm	








1117	56	HMI-GS-1106	WEBSTER Needle Holder 13cm		
1118	56	HMI-GS-1107	M.G. HOSPITAL Needle Holder 17.5 cm Heavy pattern		
1119	56	HMI-GS-1108	MAYO-HEGAR Needle Holder 14cm	   06-130 14cm 06-131 16cm 06-132 18cm 	
1120	56	HMI-GS-1109	MAYO-HEGAR Needle Holder 16cm		
1121	56	HMI-GS-1110	MAYO-HEGAR Needle Holder 18cm		
1122	56	HMI-GS-1111	MAYO-HEGAR Needle Holder 20cm		
1123	56	HMI-GS-1112	MAYO-HEGAR Needle Holder 24cm		
1124	56	HMI-GS-1113	MAYO-HEGAR Needle Holder 26cm		   

				06-133 20cm	06-134 24cm	06-135 26cm	06-136 30cm
1125	56	HMI-GS-1114	MAYO-HEGAR Needle Holder 30cm				
1126	56	HMI-GS-1115	CRILE-WOOD Needle Holder 150cm				
1127	56	HMI-GS-1116	CRILE-MURRAY Needle Holder 15 cm				
1128	57	HMI-GS-1117	WRIGHT NEEDLE HOLDERS 13cm				
1129	57	HMI-GS-1118	BRUCE-CLARKE NEEDLE HOLDERS 12.5cm				
1130	57	HMI-GS-1119	KILNER NEEDLE HOLDERS 13.5 cm				
1131	57	HMI-GS-1120	THOMSON WALKER NEEDLE HOLDERS 20cm				
1132	57	HMI-GS-1121	BOZEMANN NEEDLE HOLDERS 20cm				

1133	57	HMI-GS-1122	METZENBAUM NEEDLE HOLDERS 18cm	
1134	57	HMI-GS-1123	FINOCCHIETTO NEEDLE HOLDERS 27cm	
1135	57	HMI-GS-1124	WANGENSTEEN NEEDLE HOLDERS 27cm	
1136	58	HMI-GS-1125	MASSON NEEDLE HOLDERS 27 cm, 10 3/4"	
1137	58	HMI-GS-1126	SAROT NEEDLE HOLDERS 27cm	
1138	58	HMI-GS-1127	OLSEN NEEDLE HOLDERS 14cm	 <p>06-260 14cm 06-261 16.5 cm</p> <p>06-262 19 cm</p>
1139	58	HMI-GS-1128	OLSEN NEEDLE HOLDERS 16.5 cm	
1140	58	HMI-GS-1129	OLSEN NEEDLE HOLDERS 19 cm	

1141	58	HMI-GS-1130	GILLIES NEEDLE HOLDERS 16 cm	
1142	58	HMI-GS-1131	MATHIEU NEEDLE HOLDERS 11cm	 <p>06-280 11cm 06-281 14cm 06-282 17cm</p>
1143	58	HMI-GS-1132	MATHIEU NEEDLE HOLDERS 14cm	
1144	58	HMI-GS-1133	MATHIEU NEEDLE HOLDERS 17cm	
1145	58	HMI-GS-1134	MATHIEU NEEDLE HOLDERS 14cm	
1146	58	HMI-GS-1135	MATHIEU NEEDLE HOLDERS 17cm	 <p>06-290 14cm 06-291 17cm 06-292 20cm 06-293 24cm</p>
1147	58	HMI-GS-1136	MATHIEU NEEDLE HOLDERS 20cm	
1148	58	HMI-GS-1137	MATHIEU NEEDLE HOLDERS 24cm	

1149	58	HMI-GS-1138	LANGENBECK NEEDLE HOLDERS 18.5cm	
1150	59	HMI-GS-1139	CRILE NEEDLE HOLDERS 15 cm, 6"	
1151	59	HMI-GS-1140	MACPHHAIL NEEDLE HOLDERS 14 cm	
1152	59	HMI-GS-1141	MACPHHAIL NEEDLE HOLDERS 16 cm	
1153	59	HMI-GS-1142	MACPHHAIL NEEDLE HOLDERS 18 cm	
1154	59	HMI-GS-1143	MACPHHAIL NEEDLE HOLDERS 20 cm	
1155	59	HMI-GS-1144	HALSTEAD NEEDLE HOLDERS 16.5cm	
1156	59	HMI-GS-1145	HALSTEAD NEEDLE HOLDERS 21cm	

1157	59	HMI-GS-1146	HALSTEAD NEEDLE HOLDERS 24cm	
1158	59	HMI-GS-1147	ROCHESTER-MAYO NEEDLE HOLDERS 18 cm, 8" button release, screw joint.	
1159	59	HMI-GS-1148	ROCHESTER-MAYO NEEDLE HOLDERS 23 cm, 9" button release, screw joint.	
1160	59	HMI-GS-1149	STEVENS NEEDLE HOLDERS 13cm	
1161	59	HMI-GS-1150	KALT-ARRUGA NEEDLE HOLDERS 14cm	
1162	59	HMI-GS-1151	KALT NEEDLE HOLDERS 14cm	
1163	59	HMI-GS-1152	CASTROVIEJO NEEDLE HOLDERS 14cm	
1164	59	HMI-GS-1153	DESCHAMPS NEEDLE HOLDERS 21cm L	











1165	59	HMI-GS-1154	DESCHAMPS NEEDLE HOLDERS 21cm R	
1166	59	HMI-GS-1155	DESCHAMPS NEEDLE HOLDERS 21cm L	
1167	59	HMI-GS-1156	DESCHAMPS NEEDLE HOLDERS 21cm R	
1168	60	HMI-GS-1157	REVERDIN NEEDLES Fig. 1 14.5cm	      
1169	60	HMI-GS-1158	REVERDIN NEEDLES Fig. 2 14.5cm	
1170	60	HMI-GS-1159	REVERDIN NEEDLES Fig. 3 14.5cm	
1171	60	HMI-GS-1160	REVERDIN NEEDLES Fig. 4 14.5cm	
1172	60	HMI-GS-1161	REVERDIN NEEDLES	

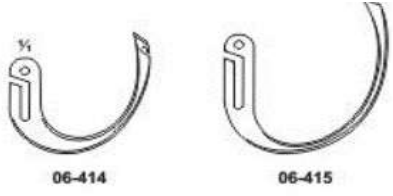

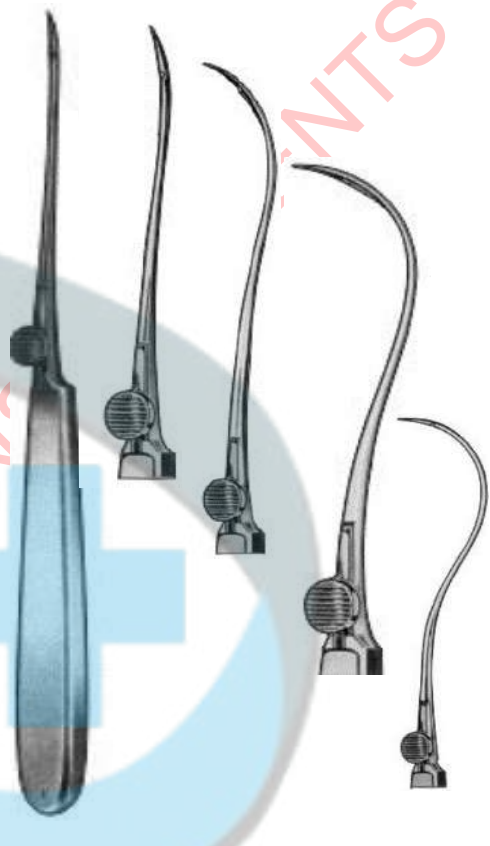

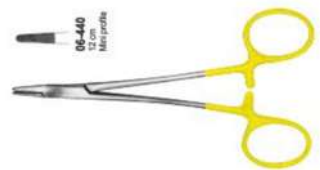



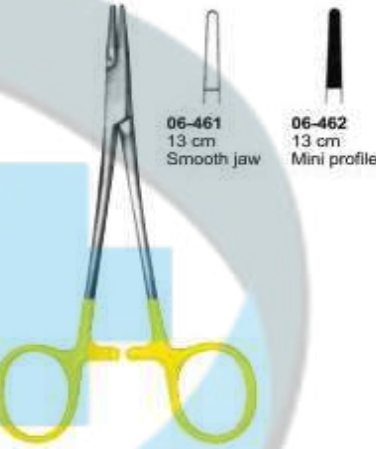
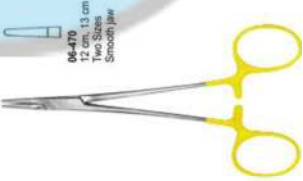
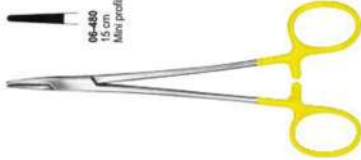
Fig. 2 06-411 14.5cm

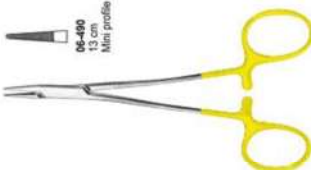



Fig. 3 06-412 14.5cm


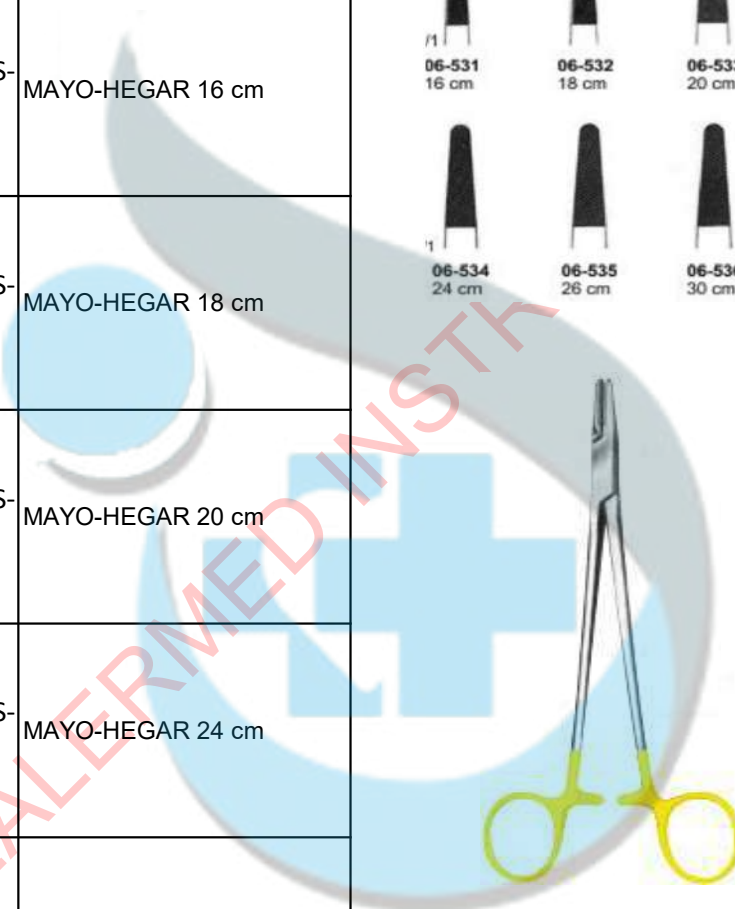
Fig. 4 06-413 14.5cm

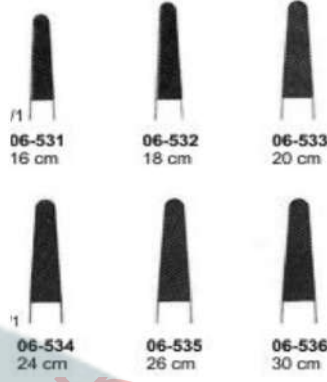
Fig. 1 06-410 14.5cm


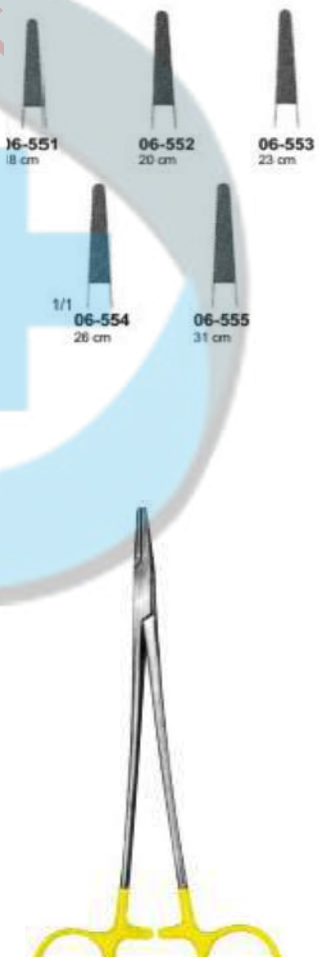
1173	60	HMI-GS-1162	REVERDIN NEEDLES	
1174	60	HMI-GS-1163	REVERDIN NEEDLES	
1175	60	HMI-GS-1164	REVERDIN NEEDLES Fig. 1	
1176	60	HMI-GS-1165	REVERDIN NEEDLES Fig. 2	
1177	60	HMI-GS-1166	REVERDIN NEEDLES Fig. 3	
1178	60	HMI-GS-1167	REVERDIN NEEDLES Fig. 4	
1179	60	HMI-GS-1168	YOUNG BOOMRANG NEEDLES 25cm	
1180	61	HMI-GS-1169	DERF NEEDLE HOLDERS T.C. 12 cm Mini profile	





1181	61	HMI-GS-1170	HEGAR-BAUMGARTNER NEEDLE HOLDERS T.C.	
1182	61	HMI-GS-1171	HEGAR-BAUMGARTNER NEEDLE HOLDERS T.C.13 cm Mini profile	
1183	61	HMI-GS-1172	HEGAR-BAUMGARTNER NEEDLE HOLDERS T.C.14.5 cm Mini profile	
1184	61	HMI-GS-1173	HALSEY NEEDLE HOLDERS T.C.	
1185	61	HMI-GS-1174	HALSEY NEEDLE HOLDERS T.C. 13 cm Smooth jaw	
1186	61	HMI-GS-1175	HALSEY NEEDLE HOLDERS T.C. 13 cm Mini profile	
1187	61	HMI-GS-1176	WEBSTER NEEDLE HOLDERS T.C. 12 cm, 13 cm Two Sizes Smooth jaw	
1188	61	HMI-GS-1177	CRILE-WOOD NEEDLE HOLDERS T.C. 15 cm Mini profile	

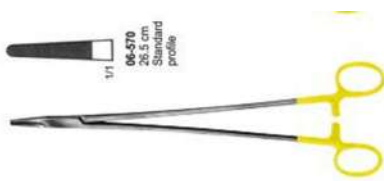



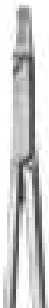
1189	61	HMI-GS-1178	KILNER NEEDLE HOLDERS T.C. 13 cm Mini profile	
1190	62	HMI-GS-1179	WEBSTER 13 cm	 1/1 WEBSTER 06-501 13 cm Mini profile CRILE-WOOD 06-502 15 cm
1191	62	HMI-GS-1180	WEBSTER 13 cm Mini profile	
1192	62	HMI-GS-1181	CRILE-WOOD 15 cm	
1193	62	HMI-GS-1182	CRILE-WOOD 20.5 cm Mini profile	 1/1 06-510 20.5 cm Mini profile
1194	62	HMI-GS-1183	SAROT 18 cm Standard profile	 1/1 06-521 18 cm Standard profile 06-522 20 cm Standard profile 06-523 26 cm Standard profile
1195	62	HMI-GS-1184	SAROT 18 cm Standard profile	
1196	62	HMI-GS-1185	SAROT 20 cm Standard profile	


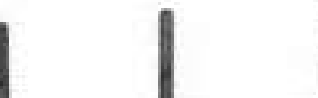

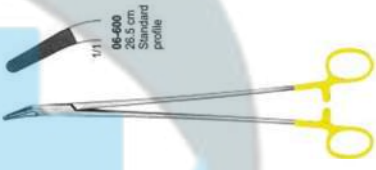
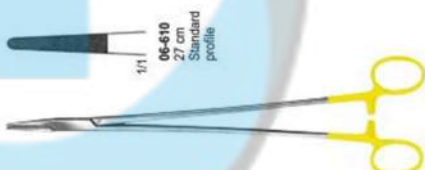


1197	62	HMI-GS-1186	SAROT 26 cm Standard profile	
1198	62	HMI-GS-1187	MAYO-HEGAR Standard Profile	
1199	62	HMI-GS-1188	MAYO-HEGAR 16 cm	
1200	62	HMI-GS-1189	MAYO-HEGAR 18 cm	
1201	62	HMI-GS-1190	MAYO-HEGAR 20 cm	
1202	62	HMI-GS-1191	MAYO-HEGAR 24 cm	
1203	62	HMI-GS-1192	MAYO-HEGAR 26 cm	
1204	62	HMI-GS-1193	MAYO-HEGAR 30 cm	




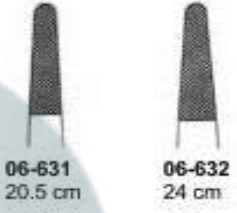




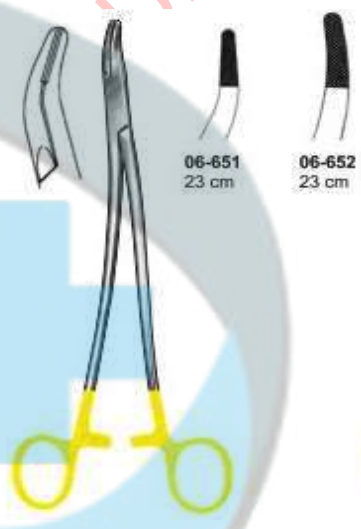
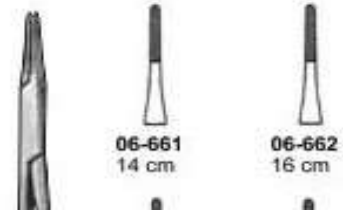
1205	62	HMI-GS-1194	HEANEY 20 cm	 <p>06-541 20 cm</p> <p>06-542 24 cm</p> <p>06-543 26 cm</p>
1206	62	HMI-GS-1195	HEANEY 24 cm	
1207	62	HMI-GS-1196	HEANEY 26 cm	
1208	62	HMI-GS-1197	DeBakey Delicate pattern mini profile	 <p>06-551 18 cm</p> <p>06-552 20 cm</p> <p>06-553 23 cm</p> <p>06-554 26 cm</p> <p>06-555 31 cm</p>
1209	62	HMI-GS-1198	DeBakey Delicate pattern 18 cm	
1210	62	HMI-GS-1199	DeBakey Delicate pattern 20 cm	
1211	62	HMI-GS-1200	DeBakey Delicate pattern 23 cm	
1212	62	HMI-GS-1201	DeBakey Delicate pattern 26 cm	




1213	62	HMI-GS-1202	DeBaKey Delicate pattern 31 cm		
1214	63	HMI-GS-1203	RAYDER NEEDLE HOLDERS T.C. Mini profile		
1215	63	HMI-GS-1204	RAYDER NEEDLE HOLDERS T.C. 12.5 cm		
1216	63	HMI-GS-1205	RAYDER NEEDLE HOLDERS T.C. 15 cm		
1217	63	HMI-GS-1206	RAYDER NEEDLE HOLDERS T.C. 18 cm		
1218	63	HMI-GS-1207	RAYDER NEEDLE HOLDERS T.C. 20 cm		
1219	63	HMI-GS-1208	RAYDER NEEDLE HOLDERS T.C. 23 cm		
1220	63	HMI-GS-1209	RAYDER NEEDLE HOLDERS T.C. 26 cm		

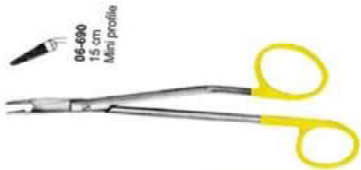
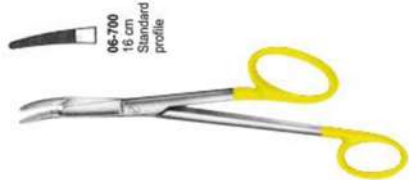
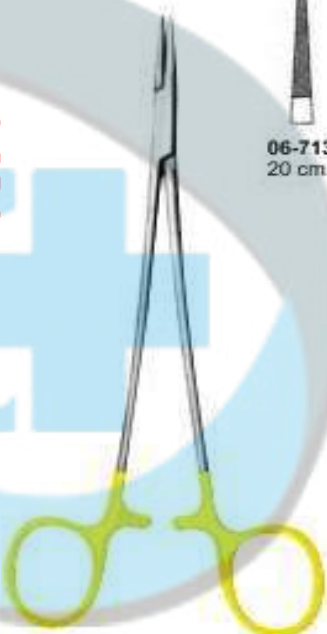






1221	63	HMI-GS-1210	MASSON NEEDLE HOLDERS T.C. 26.5 cm Standard profile	
1222	63	HMI-GS-1211	MASSON NEEDLE HOLDERS T.C. mini profile elastic type	
1223	63	HMI-GS-1212	MASSON NEEDLE HOLDERS T.C. 15 cm	
1224	63	HMI-GS-1213	MASSON NEEDLE HOLDERS T.C. 17 cm	
1225	63	HMI-GS-1214	MASSON NEEDLE HOLDERS T.C. 20 cm	
1226	63	HMI-GS-1215	RYDER-VASCULAR NEEDLE HOLDERS T.C. Slender pattern micro profile	
1227	63	HMI-GS-1216	RYDER-VASCULAR NEEDLE HOLDERS T.C.12.5 cm	
1228	63	HMI-GS-1217	RYDER-VASCULAR NEEDLE HOLDERS T.C.15.5 cm	





1229	63	HMI-GS-1218	RYDER-VASCULAR NEEDLE HOLDERS T.C.17.5 cm	
1230	63	HMI-GS-1219	RYDER-VASCULAR NEEDLE HOLDERS T.C.20 cm	
1231	63	HMI-GS-1220	RYDER-VASCULAR NEEDLE HOLDERS T.C.22.5 cm	
1232	63	HMI-GS-1221	RYDER-VASCULAR NEEDLE HOLDERS T.C.26 cm	 <p>1/1 06-594 20 cm 06-595 22.5 cm 06-596 26 cm</p>
1233	63	HMI-GS-1222	FINOCHIETTO NEEDLE HOLDERS T.C. 26.5 cm Standard profile	 <p>1/1 06-600 26.5 cm Standard profile</p>
1234	63	HMI-GS-1223	WANGENSTEEN NEEDLE HOLDERS T.C. 27 cm Standard profile	 <p>1/1 06-610 27 cm Standard profile</p>
1235	64	HMI-GS-1224	HEGAR-VASCULAR NEEDLE HOLDERS T.C. Micro profile	 <p>06-621 14 cm 06-622 18.5 cm</p>
1236	64	HMI-GS-1225	HEGAR-VASCULAR NEEDLE HOLDERS T.C. 14 cm	







1237	64	HMI-GS-1226	HEGAR-VASCULAR NEEDLE HOLDERS T.C. 18.5 cm		
1238	64	HMI-GS-1227	HEGAR-VASCULAR NEEDLE HOLDERS T.C. 20.5 cm		
1239	64	HMI-GS-1228	HEGAR-VASCULAR NEEDLE HOLDERS T.C. 23 cm		
1240	64	HMI-GS-1229	HEGAR-VASCULAR NEEDLE HOLDERS T.C. Micro profile		
1241	64	HMI-GS-1230	HEGAR-VASCULAR NEEDLE HOLDERS T.C. 20.5 cm		
1242	64	HMI-GS-1231	HEGAR-VASCULAR NEEDLE HOLDERS T.C. 24 cm		
1243	64	HMI-GS-1232	HEGAR-VASCULAR NEEDLE HOLDERS T.C. 26.5 cm		
1244	64	HMI-GS-1233	HEGAR-VASCULAR NEEDLE HOLDERS T.C. 29 cm		










1245	64	HMI-GS-1234	HEGAR NEEDLE HOLDERS T.C. Standard profile	
1246	64	HMI-GS-1235	HEGAR NEEDLE HOLDERS T.C. 20 cm	
1247	64	HMI-GS-1236	HEGAR NEEDLE HOLDERS T.C. 23.5 cm	
1248	64	HMI-GS-1237	STRATTE NEEDLE HOLDERS T.C. Standard profile	
1249	64	HMI-GS-1238	STRATTE NEEDLE HOLDERS T.C. 23 cm	
1250	64	HMI-GS-1239	STRATTE NEEDLE HOLDERS T.C. 23 cm	
1251	64	HMI-GS-1240	MARTINI NEEDLE HOLDERS T.C. Slender pattern, micro profile	
1252	64	HMI-GS-1241	MARTINI NEEDLE HOLDERS T.C. 14 cm	


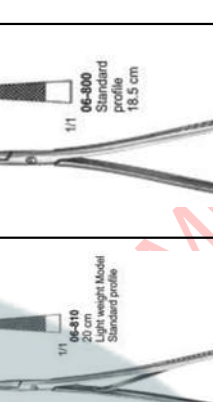

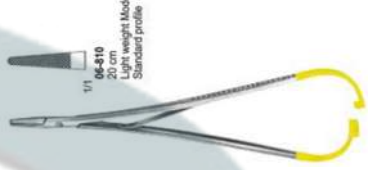



1253	64	HMI-GS-1242	MARTINI NEEDLE HOLDERS T.C. 16 cm	
1254	64	HMI-GS-1243	MARTINI NEEDLE HOLDERS T.C. 17.5 cm	
1255	64	HMI-GS-1244	MARTINI NEEDLE HOLDERS T.C. 20 cm	
1256	64	HMI-GS-1245	OLSEN-HEGAR NEEDLE HOLDERS T.C. Standard profile	
1257	64	HMI-GS-1246	OLSEN-HEGAR NEEDLE HOLDERS T.C. 14.5 cm	
1258	64	HMI-GS-1247	OLSEN-HEGAR NEEDLE HOLDERS T.C. 17 cm	
1259	64	HMI-GS-1248	OLSEN-HEGAR NEEDLE HOLDERS T.C. 19 cm	
1260	65	HMI-GS-1249	FOSTER-GILLIES NEEDLE HOLDERS T.C. 11 cm Smooth jaw	
				

1261	65	HMI-GS-1250	GILLIES-MINI NEEDLE HOLDERS T.C. 15 cm Mini profile		
1262	65	HMI-GS-1251	GILLIES NEEDLE HOLDERS T.C. 16 cm Standard profile		
1263	65	HMI-GS-1252	MICROVASCULAR Slender pattern, micro profile	 <div style="display: flex; flex-wrap: wrap; justify-content: space-around;"> <div style="text-align: center;">  06-711 14 cm </div> <div style="text-align: center;">  06-712 17.5 cm </div> <div style="text-align: center;">  06-713 20 cm </div> <div style="text-align: center;">  06-714 23 cm </div> </div>	
1264	65	HMI-GS-1253	MICROVASCULAR Slender pattern, micro profile 14 cm		
1265	65	HMI-GS-1254	MICROVASCULAR Slender pattern, micro profile 17.5 cm		
1266	65	HMI-GS-1255	MICROVASCULAR Slender pattern, micro profile 20 cm		
1267	65	HMI-GS-1256	MICROVASCULAR Slender pattern, micro profile 23 cm		
1268	65	HMI-GS-1257	MARTINI NEEDLE HOLDERS T.C. Slender pattern, smooth jaw		<div style="display: flex; justify-content: space-around;"> <div style="text-align: center;">  06-721 14 cm </div> <div style="text-align: center;">  06-722 16 cm </div> </div>

1269	65	HMI-GS-1258	MARTINI NEEDLE HOLDERS T.C. 14 cm	 06-723 17.5 cm  06-724 20 cm
1270	65	HMI-GS-1259	MARTINI NEEDLE HOLDERS T.C. 16 cm	
1271	65	HMI-GS-1260	MARTINI NEEDLE HOLDERS T.C. 17.5 cm	
1272	65	HMI-GS-1261	MARTINI NEEDLE HOLDERS T.C. 20 cm	
1273	66	HMI-GS-1262	ARRUGA NEEDLE HOLDERS T.C.	
1274	66	HMI-GS-1263	ARRUGA NEEDLE HOLDERS T.C. 16 cm Mini profile	
1275	66	HMI-GS-1264	ARRUGA NEEDLE HOLDERS T.C. 16 cm	
1276	66	HMI-GS-1265	CASTROVIEJO NEEDLE HOLDERS T.C. 12.5 cm With lock, smooth jaw	





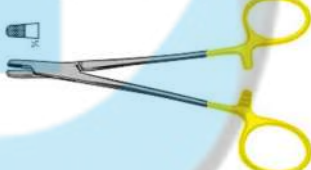


1277	66	HMI-GS-1266	BARRAQUER NEEDLE HOLDERS T.C. 13 cm With lock, smooth jaw	 <p>06-750 13 cm With lock, smooth jaw</p>
1278	66	HMI-GS-1267	BARRAQUER NEEDLE HOLDERS T.C. 13 cm Smooth jaw	 <p>06-760 13 cm Smooth jaw</p>
1279	66	HMI-GS-1268	CASTROVIEJO NEEDLE HOLDERS T.C.	 <p>06-771 With lock 14.5 cm</p>  <p>06-772 With lock 14.5 cm</p>  <p>06-773 14.5 cm Smooth jaw</p>
1280	66	HMI-GS-1269	CASTROVIEJO NEEDLE HOLDERS T.C. With lock 14.5 cm	
1281	66	HMI-GS-1270	CASTROVIEJO NEEDLE HOLDERS T.C. With lock 14.5 cm	
1282	66	HMI-GS-1271	CASTROVIEJO NEEDLE HOLDERS T.C. 14.5 cm Smooth jaw	
1283	66	HMI-GS-1272	CASTROVIEJO NEEDLE HOLDERS T.C. 18 cm With lock	
1284	66	HMI-GS-1273	CASTROVIEJO NEEDLE HOLDERS T.C. 21.5 cm With lock	


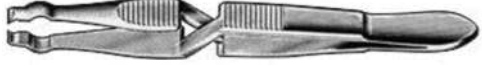



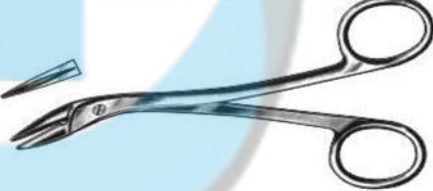


1285	66	HMI-GS-1274	CASTROVIEJO NEEDLE HOLDERS T.C. 14.5 cm Smooth	 06-776 14.5 cm Smooth	 06-777 18 cm With lock	 06-778 With lock 21.5 cm
1286	66	HMI-GS-1275	CASTROVIEJO NEEDLE HOLDERS T.C. 18 cm With lock			
1287	66	HMI-GS-1276	CASTROVIEJO NEEDLE HOLDERS T.C. With lock 21.5 cm			
1288	67	HMI-GS-1277	NEEDLE HOLDERS T.C. Standard profile		 1/1 06-781 18 cm	 06-782 20.5 cm
1289	67	HMI-GS-1278	NEEDLE HOLDERS T.C. 18 cm			
1290	67	HMI-GS-1279	NEEDLE HOLDERS T.C. 20.5 cm			
1291	67	HMI-GS-1280	NEEDLE HOLDERS T.C. 23 cm		 06-783 23 cm	
1292	67	HMI-GS-1281	ZWEIFEL NEEDLE HOLDERS T.C. Standard profile			




1293	67	HMI-GS-1282	ZWEIFEL NEEDLE HOLDERS T.C. 20.5 cm	
1294	67	HMI-GS-1283	ZWEIFEL NEEDLE HOLDERS T.C. 23 cm	
1295	67	HMI-GS-1284	TOENNIS NEEDLE HOLDERS T.C. Standard profile 18.5 cm	
1296	67	HMI-GS-1285	LICHTENBERG NEEDLE HOLDERS T.C. 20 cm Light weight Model Standard profile	
1297	67	HMI-GS-1286	MATHIEU NEEDLE HOLDERS T.C. Standard profile	  
1298	67	HMI-GS-1287	MATHIEU NEEDLE HOLDERS T.C. 14 cm	
1299	67	HMI-GS-1288	MATHIEU NEEDLE HOLDERS T.C. 17 cm	
1300	67	HMI-GS-1289	MATHIEU NEEDLE HOLDERS T.C. 20 cm	




1301	67	HMI-GS-1290	MATHIEU NEEDLE HOLDERS T.C. Standard profile	
1302	67	HMI-GS-1291	MATHIEU NEEDLE HOLDERS T.C. 14 cm	
1303	67	HMI-GS-1292	MATHIEU NEEDLE HOLDERS T.C. 17 cm	
1304	67	HMI-GS-1293	MATHIEU NEEDLE HOLDERS T.C. 20 cm	
1305	67	HMI-GS-1294	MATHIEU NEEDLE HOLDERS T.C. Standard profile	
1306	67	HMI-GS-1295	MATHIEU NEEDLE HOLDERS T.C. 17 cm	
1307	67	HMI-GS-1296	MATHIEU NEEDLE HOLDERS T.C. 20 cm	
1308	67	HMI-GS-1297	MATHIEU NEEDLE HOLDERS T.C. 23 cm	


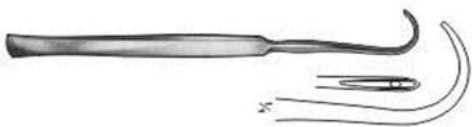




1309	68	HMI-GS-1298	BABCOCK NEEDLE HOLDERS T.C. 16.5 cm, 6 1/2"	
1310	68	HMI-GS-1299	BABCOCK NEEDLE HOLDERS T.C. 20.3 cm, 8"	
1311	68	HMI-GS-1300	BABCOCK NEEDLE HOLDERS T.C. 17.5 cm, 7"	
1312	68	HMI-GS-1301	BABCOCK NEEDLE HOLDERS T.C. 19.5 cm, 8"	
1313	68	HMI-GS-1302	DUVAL NEEDLE HOLDERS T.C. 13 cm, 5 1/4"	
1314	68	HMI-GS-1303	DUVAL NEEDLE HOLDERS T.C. 18 cm, 7"	
1315	68	HMI-GS-1304	WIRE TWISTERS NEEDLE HOLDERS T.C. 15.2 cm, 6" Delicate.	
1316	68	HMI-GS-1305	WIRE TWISTERS NEEDLE HOLDERS T.C. 15.2 cm, 6"	









1317	68	HMI-GS-1306	WIRE TWISTERS NEEDLE HOLDERS T.C. 18 cm, 7"	 <p>18 cm, 7" 06-873 20 cm, 8" Heavy</p>
1318	68	HMI-GS-1307	WIRE TWISTERS NEEDLE HOLDERS T.C. 20 cm, 8" Heavy	
1319	68	HMI-GS-1308	STERNUM NEEDLE HOLDERS T.C. 17.5 cm, 7" Wire Twister	
1320	68	HMI-GS-1309	WIRE TIGHTENING PLIERS 18 cm, 7"	
1321	68	HMI-GS-1310	COOLEY-BAUMGAFTEN WIRE TWISTER 20.3 cm, 8" Extra heavy needle holder designed for twisting of wire and placement of retention suture. Heavy, blunt jaws.	
1322	68	HMI-GS-1311	RUBIO WIRE TWISTER 12.7 cm, 5 1/4"	
1323	69	HMI-GS-1312	MICHEL 12cm	
1324	69	HMI-GS-1313	MICHEL 12cm	






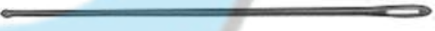


1325	69	HMI-GS-1314	WACHENFELDT 12.5cm	
1326	69	HMI-GS-1315	WACHENFELDT 12.5cm	
1327	69	HMI-GS-1316	HEGENBARTH 12.5cm	
1328	69	HMI-GS-1317	CHILDE 18cm	
1329	69	HMI-GS-1318	CHILDE 18cm	
1330	69	HMI-GS-1319	RICHTER-HEATH 14cm	
1331	69	HMI-GS-1320	COLLIN 13cm	
1332	69	HMI-GS-1321	MICHEL 12cm	






1333	70	HMI-GS-1322	PROBES 11.5cm		
1334	70	HMI-GS-1323	PROBES 12.5cm		
1335	70	HMI-GS-1324	PROBES 14 cm		
1336	70	HMI-GS-1325	PROBES 16 cm		
1337	70	HMI-GS-1326	PROBES 18 cm		
1338	70	HMI-GS-1327	PROBES 20 cm		
1339	70	HMI-GS-1328	PROBES 25 cm		
1340	70	HMI-GS-1329	PROBES		
1341	70	HMI-GS-1330	PROBES		
1342	70	HMI-GS-1331	PROBES		
1343	70	HMI-GS-1332	PROBES		
1344	70	HMI-GS-1333	PROBES		
1345	70	HMI-GS-1334	PROBES		
1346	70	HMI-GS-1335	PROBES		
1347	70	HMI-GS-1336	PROBES 12.5cm		
1348	70	HMI-GS-1337	PROBES 14 cm		






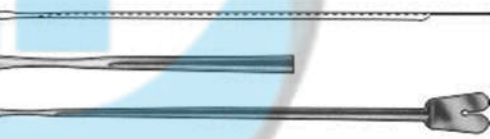


1349	70	HMI-GS-1338	PROBES 16 cm	
1350	70	HMI-GS-1339	DIRECTOR 12.5cm	
1351	70	HMI-GS-1340	DIRECTOR 14 cm	
1352	70	HMI-GS-1341	DIRECTOR 16 cm	
1353	70	HMI-GS-1342	DIRECTOR	
1354	70	HMI-GS-1343	DIRECTOR	
1355	70	HMI-GS-1344	DIRECTOR	
1356	70	HMI-GS-1345	MAYO 14cm	
1357	70	HMI-GS-1346	PLASTER 13cm	
1358	70	HMI-GS-1347	PLASTER 16cm	

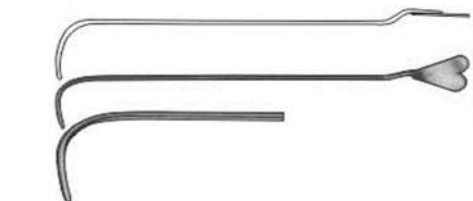
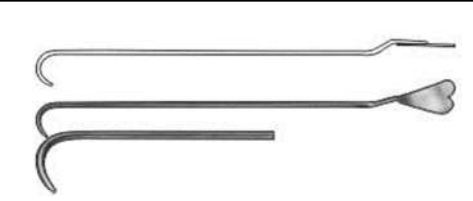
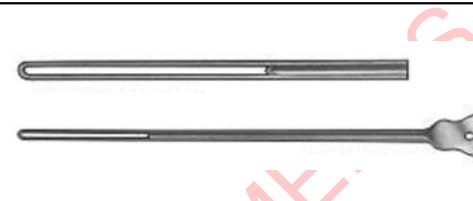
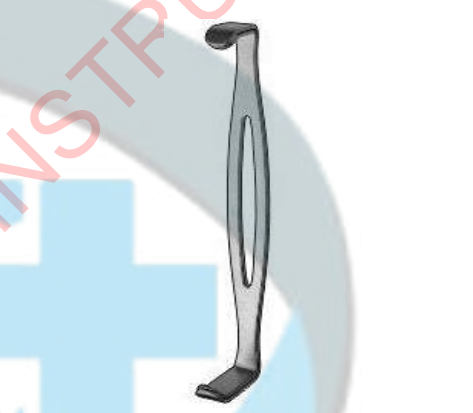
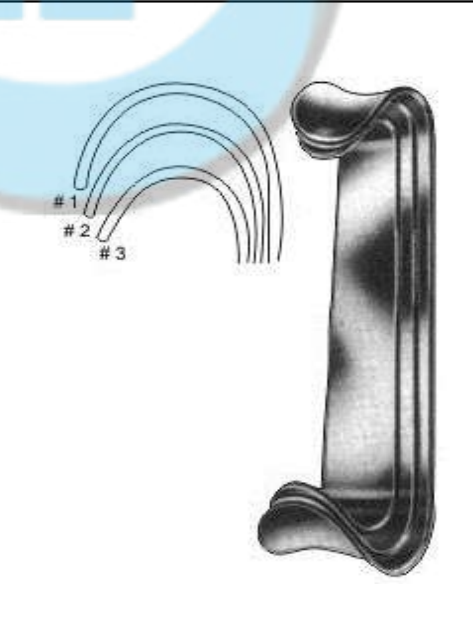
1359	70	HMI-GS-1348	PLASTER 13cm	
1360	70	HMI-GS-1349	SYME	
1361	70	HMI-GS-1350	McDONALD 19cm	
1362	70	HMI-GS-1351	CHEYNE 12.5cm	
1363	70	HMI-GS-1352	CHEYNE 17.5cm	
1364	70	HMI-GS-1353	FARRELL APPLICATORS 12cm	
1365	70	HMI-GS-1354	FARRELL APPLICATORS 14cm	
1366	70	HMI-GS-1355	FARRELL APPLICATORS 16cm	
1367	70	HMI-GS-1356	FARRELL APPLICATORS 18cm	
1368	70	HMI-GS-1357	FARRELL APPLICATORS	
1369	70	HMI-GS-1358	FARRELL APPLICATORS	
1370	70	HMI-GS-1359	FARRELL APPLICATORS	
1371	70	HMI-GS-1360	FARRELL APPLICATORS	




1372	70	HMI-GS-1361	JOBSON-HORNE 12.5cm	
1373	70	HMI-GS-1362	JOBSON-HORNE 18 cm	
1374	71	HMI-GS-1363	BOWMAN LACRIMAL PROBES Double Ended, Sterling Silver Bowman Probe, 000-0000	
1375	71	HMI-GS-1364	BOWMAN LACRIMAL PROBES Double Ended, Sterling Silver Bowman Probe, 00-0	
1376	71	HMI-GS-1365	BOWMAN LACRIMAL PROBES Double Ended, Sterling Silver Bowman Probe, 1-2	
1377	71	HMI-GS-1366	BOWMAN LACRIMAL PROBES Double Ended, Sterling Silver Bowman Probe, 3-4	
1378	71	HMI-GS-1367	BOWMAN LACRIMAL PROBES Double Ended, Sterling Silver Bowman Probe, 5-6	
1379	71	HMI-GS-1368	BOWMAN LACRIMAL PROBES Double Ended, Sterling Silver Bowman Probe, 7-8	
1380	71	HMI-GS-1369	WILLIAM LACRIMAL PROBES Double Ended, Sterling Silver William Probe, 000-0000	












1381	71	HMI-GS-1370	WILLIAM LACRIMAL PROBES Double Ended, Sterling Silver William Probe, 00-0	
1382	71	HMI-GS-1371	WILLIAM LACRIMAL PROBES Double Ended, Sterling Silver William Probe, 1-2	
1383	71	HMI-GS-1372	WILLIAM LACRIMAL PROBES Double Ended, Sterling Silver William Probe, 3-4	
1384	71	HMI-GS-1373	WILLIAM LACRIMAL PROBES Double Ended, Sterling Silver William Probe, 5-6	
1385	71	HMI-GS-1374	WILLIAM LACRIMAL PROBES Double Ended, Sterling Silver William Probe, 7-8	
1386	71	HMI-GS-1375	Probe 14.5 cm, 5 3/4" probes with eye	
1387	71	HMI-GS-1376	Probe 16.0 cm, 6 1/4" probes with eye	
1388	71	HMI-GS-1377	Probe 20.0 cm, 8" probes with eye	
1389	71	HMI-GS-1378	Myrtle leaf probe 14.5 cm, 5 3/4"	
1390	71	HMI-GS-1379	Probe 13.0 cm, 5"	






















1391	71	HMI-GS-1380	Probe 14.5 cm, 5 ¾"	
1392	71	HMI-GS-1381	Probe 16.0 cm, 6 ¼"	
1393	71	HMI-GS-1382	Probe 18.5 cm, 7"	
1394	71	HMI-GS-1383	Probe 20.0 cm, 8"	
1395	71	HMI-GS-1384	probe	
1396	71	HMI-GS-1385	probe 19.0 cm, 8 ¼" Double ended probe, malleable, diam, of tips 3 mm with hole	
1397	71	HMI-GS-1386	probe 1.5 mm 30.0 cm, 12"	
1398	71	HMI-GS-1387	probe 2.0 mm 30.0 cm, 12"	
1399	71	HMI-GS-1388	probe 2.5 mm 30.0 cm, 12"	
1400	72	HMI-GS-1389	DIRECTORS 13 cm, 5"	




1401	72	HMI-GS-1390	DIRECTORS 14.5 cm, 5 3/4"	
1402	72	HMI-GS-1391	DIRECTORS 16 cm, 6"	
1403	72	HMI-GS-1392	DOYEN 14.5 cm, 5 3/4"	
1404	72	HMI-GS-1393	NELATON 16 cm, 6"	
1405	72	HMI-GS-1394	NELATON 14 cm, 5 1/2" Director with tip Diam. Of tip 3.3 mm	
1406	72	HMI-GS-1395	BRODIE 20 cm, 8" Director with tip Diam. Of tip 3.5 mm	
1407	72	HMI-GS-1396	LOCKHART-MUMMERY 16.5 cm, 6 1/2"	
1408	72	HMI-GS-1397	LOCKHART-MUMMERY 16.5 cm, 6 1/2"	



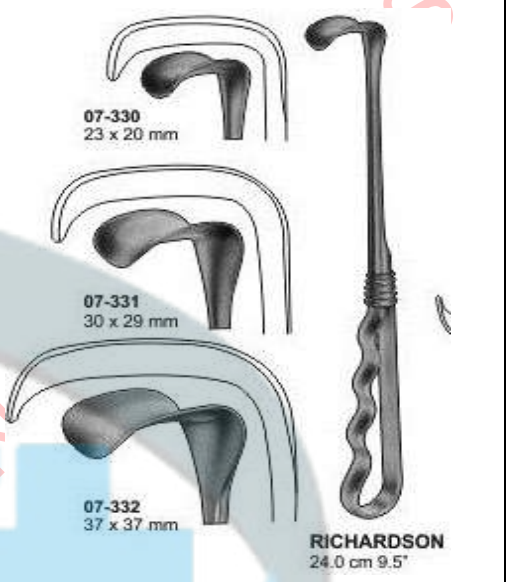

1409	72	HMI-GS-1398	LOCKHART-MUMMERY 16.5 cm, 6 1/2"	
1410	72	HMI-GS-1399	LOCKHART-MUMMERY 16.5 cm, 6 1/2"	
1411	72	HMI-GS-1400	LOCKHART-MUMMERY 19 cm, 7 1/4" director with wire loop, malleable	
1412	RETRACTORS			
1413				
1414	73	HMI-GS-1401	US-ARMY Set 2 pcs. 21.5 cm, 8 1/2" 28 x 15 / 42 x 15 mm	
1415	73	HMI-GS-1402	US-ARMY Set 2 pcs. 21.5 cm, 8 1/2" 25 x 15 / 38 x 15 mm	
1416	73	HMI-GS-1403	ROUX Set 3 pcs. consisting of # 1 14 cm, 5 1/2" 24 x 20 / 30 x 28 mm	
1417	73	HMI-GS-1404	ROUX Set 3 pcs. consisting of # 2 15 cm, 6" 29 x 26 / 36 x 36 mm	
1418	73	HMI-GS-1405	ROUX Set 3 pcs. consisting of # 3 17 cm, 6 3/4" 33 x 29 / 38 x 43 mm	

1419	73	HMI-GS-1406	FARABEU F Set 2 Pcs. 15 cm, 6" 27 x 16 / 30 x 16 mm	
1420	73	HMI-GS-1407	FARABEU F Set 2 Pcs. 15 cm, 6" 23 x 16 / 26 x 16 mm	
1421	73	HMI-GS-1408	PARKER 13.5 cm, 5 1/4" 18 x 15 mm / 19 x 15 mm	
1422	73	HMI-GS-1409	DEAVER 18 cm, 7" 19 mm	
1423	73	HMI-GS-1410	DEAVER 21.5 cm, 8 1/2" 22 mm	
1424	73	HMI-GS-1411	DEAVER 23 cm, 9" 25 mm	
1425	73	HMI-GS-1412	DEAVER 30 cm, 11 3/4" 25 mm	
1426	73	HMI-GS-1413	DEAVER 33 cm, 13" 25 mm	

1427	73	HMI-GS-1414	DEAVER 36 cm, 13 1/2" 25 mm	
1428	74	HMI-GS-1415	DEAVER 30 cm, 11 3/4" 38 mm	
1429	74	HMI-GS-1416	DEAVER 30 cm, 11 3/4" 50 mm	
1430	74	HMI-GS-1417	DEAVER 30 cm, 11 3/4" 75 mm	
1431	74	HMI-GS-1418	HARRINGTON 32 cm, 12 3/4" 127 x 40 mm	
1432	74	HMI-GS-1419	HARRINGTON 32 cm, 12 3/4" 127 x 62 mm	
1433	74	HMI-GS-1420	16 cm, 6 1/4" flexible	  07-240  07-241  07-242  07-243  
1434	74	HMI-GS-1421	17 cm, 6 1/4" flexible	
1435	74	HMI-GS-1422	18 cm, 6 1/4" flexible	
1436	74	HMI-GS-1423	19 cm, 6 1/4" flexible	

1437	74	HMI-GS-1424	20 cm, 6 1/4" flexible	  07-244  07-245
1438	74	HMI-GS-1425	21 cm, 6 1/4" flexible	
1439	74	HMI-GS-1426	16.5 cm, 6 1/2" flexible sharp	  07-250 sharp   07-251 blunt
1440	74	HMI-GS-1427	16.5 cm, 6 1/2" flexible blunt	
1441	75	HMI-GS-1428	KOCHER Sharp 22 cm, 8 3/4" 15 x 10 mm Fig. 1	  Fig. 0  Fig. 1  Fig. 2  Fig. 3  Fig. 4  Fig. 5 KOCHER Sharp
1442	75	HMI-GS-1429	KOCHER Sharp 22 cm, 8 3/4" 15 x 15 mm Fig. 2	
1443	75	HMI-GS-1430	KOCHER Sharp 22 cm, 8 3/4" 15 x 20 mm Fig. 3	
1444	75	HMI-GS-1431	KOCHER Sharp 22 cm, 8 3/4" 15 x 30 mm Fig. 4	
1445	75	HMI-GS-1432	KOCHER Sharp 22 cm, 8 3/4" 15 x 40 mm Fig. 5	
1446	75	HMI-GS-1433	KOCHER Sharp 22 cm, 8 3/4" 15 x 10 mm Fig. 1	  Fig. 0  Fig. 1  Fig. 2  Fig. 3  Fig. 4  Fig. 5
1447	75	HMI-GS-1434	KOCHER Sharp 22 cm, 8 3/4" 15 x 15 mm Fig. 2	
1448	75	HMI-GS-1435	KOCHER Sharp 22 cm, 8 3/4" 15 x 20 mm Fig. 3	
1449	75	HMI-GS-1436	KOCHER Sharp 22 cm, 8 3/4" 15 x 30 mm Fig. 4	

1450	75	HMI-GS-1437	KOCHER Sharp 22 cm, 8 3/4" 15 x 40 mm Fig. 5	 KOCHER Blunt
1451	75	HMI-GS-1438	SENN-MUELLER 18 x 6 mm 16 cm, 6 1/4" sharp	
1452	75	HMI-GS-1439	MEYERDING 18 cm, 7" 18 x 7 mm Blunt	 <p>MEYERDING 18 cm, 7"</p> <p>07-290 18 x 7 mm Blunt</p> <p>07-291 16 x 5 mm Toothed</p> <p>07-292 7 x 4 mm Toothed</p> <p>07-293 10 x 3 mm Blunt</p> <p>07-294 7 x 4 mm Saddle Shaped</p> <p>07-295 10 x 4 mm Sharp</p>
1453	75	HMI-GS-1440	MEYERDING 18 cm, 7" 16 x 5 mm Toothed	
1454	75	HMI-GS-1441	MEYERDING 18 cm, 7" 7 x 4 mm Toothed	
1455	75	HMI-GS-1442	MEYERDING 18 cm, 7" 10 x 3 mm Blunt	
1456	75	HMI-GS-1443	MEYERDING 18 cm, 7" 7 x 4 mm Saddle Shaped	
1457	75	HMI-GS-1444	MEYERDING 18 cm, 7" 10 x 4 mm Sharp	
1458	75	HMI-GS-1445	LANGENBECK 22 cm, 8 1/2"	
1459	75	HMI-GS-1446	LANGENBECK 25 x 6 mm	
1460	75	HMI-GS-1447	LANGENBECK 25 x 6 mm	
1461	75	HMI-GS-1448	LANGENBECK 35 x 11 mm	
1462	75	HMI-GS-1449	LANGENBECK 35 x 11 mm	
1463	75	HMI-GS-1450	LANGENBECK 41 x 11 mm	
1464	75	HMI-GS-1451	LANGENBECK 41 x 11 mm	







1465	75	HMI-GS-1452	LANGENBECK 70 x 14 mm	
1466	75	HMI-GS-1453	LANGENBECK 70 x 14 mm	
1467	75	HMI-GS-1454	LANGENBECK 22 cm, 8 1/2"	
1468	76	HMI-GS-1455	RICHARDSON 24.0 cm 9.5" 23 x 20 mm	 <p>07-330 23 x 20 mm</p> <p>07-331 30 x 29 mm</p> <p>07-332 37 x 37 mm</p> <p>RICHARDSON 24.0 cm 9.5"</p>
1469	76	HMI-GS-1456	RICHARDSON 24.0 cm 9.5" 30 x 29 mm	
1470	76	HMI-GS-1457	RICHARDSON 24.0 cm 9.5" 37 x 37 mm	
1471	76	HMI-GS-1458	RICHARDSON-EASTMAN 38 x 37 mm	
1472	76	HMI-GS-1459	RICHARDSON-EASTMAN 22 x 21 mm	 <p>07-340 38 x 37 mm</p> <p>07-341 22 x 21 mm</p> <p>07-342 39 x 30 mm</p> <p>07-343 64 x 43 mm</p>
1473	76	HMI-GS-1460	RICHARDSON-EASTMAN 39 x 30 mm	

1474	76	HMI-GS-1461	RICHARDSON-EASTMAN 64 x 43 mm
1475	76	HMI-GS-1462	RICHARDSON-EASTMAN 25.0 cm 10", Set of 2 piece
1476	76	HMI-GS-1463	KOCHER 40 x 10 mm 22 cm, 8 3/4"
1477	76	HMI-GS-1464	KOCHER 40 x 15 mm 22 cm, 8 3/4"
1478	76	HMI-GS-1465	KOCHER 40 x 20 mm 22 cm, 8 1/2"
1479	76	HMI-GS-1466	FRITSCH 35 x 40 mm 24 cm, 9 1/2"
1480	76	HMI-GS-1467	MORRIS 90mm
1481	76	HMI-GS-1468	MORRIS 100mm











RICHARDSON-EASTMAN
07-344
25.0 cm 10", Set of 2 piece















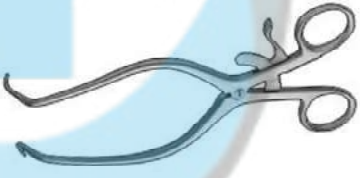


1482	76	HMI-GS-1469	MORRIS 115mm	
1483	76	HMI-GS-1470	MORRIS 48mm	
1484	76	HMI-GS-1471	LANGENBECK 22 x 6 mm	
1485	76	HMI-GS-1472	LANGENBECK 44 x 13 mm	
1486	76	HMI-GS-1473	DURHAM 13 mm	
1487	76	HMI-GS-1474	DURHAM 19 mm	
1488	76	HMI-GS-1475	CZERNY 20 mm	
1489	77	HMI-GS-1476	MEYERDING 50 x 16mm 22.5 cm, 9"	


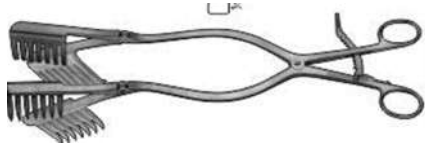

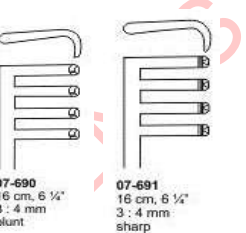




1490	77	HMI-GS-1477	MEYERDING 75 x 15mm 22.5 cm, 9"	
1491	77	HMI-GS-1478	MEYERDING 75 x 25mm 22.5 cm, 9"	
1492	77	HMI-GS-1479	SAUERBRUCH 22.5 cm, 9" 50 x 15 mm	
1493	77	HMI-GS-1480	SAUERBRUCH 22.5 cm, 9" 63 x 23 mm	
1494	77	HMI-GS-1481	SAUERBRUCH 22.5 cm, 9" 80 x 20 mm	
1495	77	HMI-GS-1482	DOYEN 50 x 85 mm 25 cm, 10"	
1496	77	HMI-GS-1483	KELLY 190 x 38 mm 27 cm, 10 1/2"	
1497	77	HMI-GS-1484	KELLY 190 x 57 mm 27 cm, 10 1/2"	

1498	77	HMI-GS-1485	MIKULICZ 26 cm, 10 ¼" 95 x 35 mm	
1499	77	HMI-GS-1486	DARTIGUS 65 x 45 mm	
1500	78	HMI-GS-1487	COOLEY 25 cm, 10" Right	
1501	78	HMI-GS-1488	COOLEY 27 cm, 10 ½" Left	
1502	78	HMI-GS-1489	COOLEY 25 cm, 10" Right - Serrated	
1503	78	HMI-GS-1490	MAYO ABDOMINAL RETRACTOR 25 cm, 10" 69 x 254 mm	
1504	78	HMI-GS-1491	C.W. MAYO ABDOMINAL RETRACTOR 25.7 cm, 10 ¼" Blade 70 mm wide.	
1505	78	HMI-GS-1492	C.W. MAYO ABDOMINAL RETRACTOR 24.8 cm, 10" Blade 79 mm wide.	

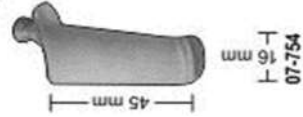

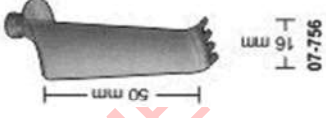





1506	78	HMI-GS-1493	BREWSTER RETRACTOR 24 cm, 9 1/2" Style A 19 x 38 mm	
1507	78	HMI-GS-1494	BREWSTER RETRACTOR 24 cm, 9 1/2" Style B 45 x 25 mm	
1508	78	HMI-GS-1495	BREWSTER RETRACTOR 24 cm, 9 1/2" Style C 50 x 45 mm	
1509	78	HMI-GS-1496	BREWSTER RETRACTOR 24 cm, 9 1/2" Style D 57 x 45 mm	
1510	78	HMI-GS-1497	BREWSTER RETRACTOR 24 cm, 9 1/2" Style E 64 x 45 mm	
1511	78	HMI-GS-1498	KELLY RETRACTOR 23 cm, 9" 38 x 50 mm	
1512	78	HMI-GS-1499	KELLY RETRACTOR 24 cm, 9 1/2" 50 x 64 mm	
1513	78	HMI-GS-1500	KELLY RETRACTOR 25 cm, 10" 64 x 76 mm	
1514	78	HMI-GS-1501	KELLY RETRACTOR 26 cm, 10 1/4" 69 x 82 mm	
1515	78	HMI-GS-1502	SIMS-KELLY RETRACTOR 57 x 25 mm 24 cm, 9 1/2"	

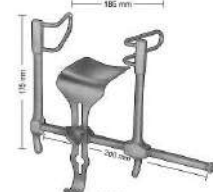
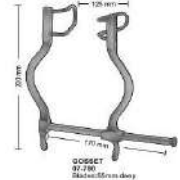

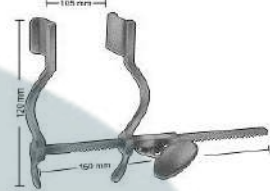
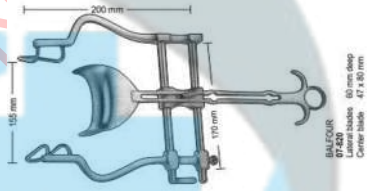
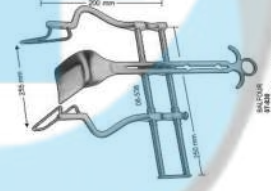

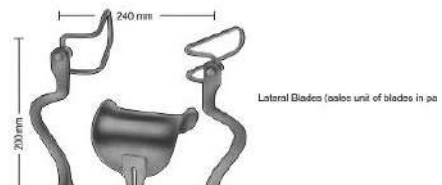
1516	78	HMI-GS-1503	SIMS-KELLY RETRACTOR 69 x 45 mm 24 cm, 9 ½"	
1517	78	HMI-GS-1504	SIMS-KELLY RETRACTOR 76 x 38 mm 24 cm, 9 ½"	
1518	78	HMI-GS-1505	ZAIKIND LUNG RETRACTOR Malleable 50 x 305 mm 25 cm, 10"	
1519	78	HMI-GS-1506	ZAIKIND LUNG RETRACTOR Malleable 76 x 305 mm 25 cm, 10"	
1520	79	HMI-GS-1507	WEITLANER Sharp 11.0 cm	
1521	79	HMI-GS-1508	WEITLANER Semi-Sharp 11.0 cm	
1522	79	HMI-GS-1509	WEITLANER Blunt 11.0 cm	
1523	79	HMI-GS-1510	WEITLANER Sharp 13.0 cm	





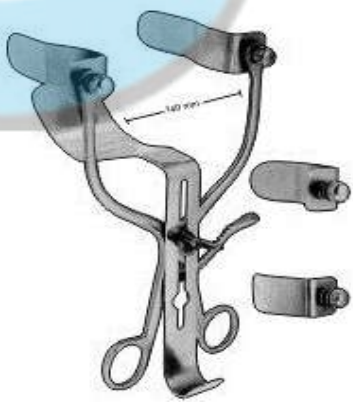
1524	79	HMI-GS-1511	WEITLANER Semi-Sharp 13.0 cm	
1525	79	HMI-GS-1512	WEITLANER Blunt 13.0 cm	
1526	79	HMI-GS-1513	MILLIGAN 18.5 mm x 20 mm Blunt, 3:3 13 cm, 5"	
1527	79	HMI-GS-1514	JANSEN 10 cm, 4" Sharp 3:3	
1528	79	HMI-GS-1515	JANSEN 10 cm, 4" Blunt 3:3	
1529	79	HMI-GS-1516	GELPI-LOKTITE 18 cm, 7"	
1530	80	HMI-GS-1517	BECKMANN-ADSON 31 cm, 12 1/4" Sharp	
1531	80	HMI-GS-1518	BECKMANN-ADSON 31 cm, 12 1/4" Semi-Sharp	



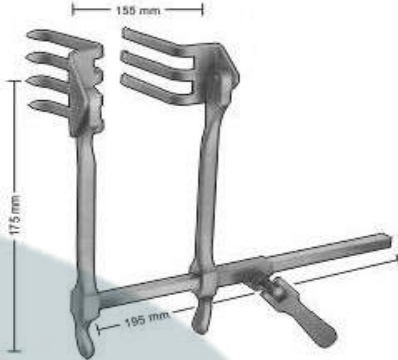




1532	80	HMI-GS-1519	ADSON 32 cm, 12 1/2" Semi-Sharp	
1533	80	HMI-GS-1520	BECKMANN-EATON 32 cm, 12 1/2" Sharp	
1534	80	HMI-GS-1521	HENLEY 16 cm, 6 1/4" 3:4 mm blunt	 <p>07-690 16 cm, 6 1/4" 3 : 4 mm blunt</p>  <p>07-691 16 cm, 6 1/4" 3 : 4 mm sharp</p>
1535	80	HMI-GS-1522	HENLEY 16 cm, 6 1/4" 3:4 mm sharp	
1536	80	HMI-GS-1523	MISKIMON 22 cm, 8 3/4" 33 mm x 38 mm Sharp, 7:7	
1537	80	HMI-GS-1524	ADSON 32 cm, 12 3/4" semi-sharp 4 x 5 teeth 26 mm	 <p>07-710 32 cm, 12 3/4" semi-sharp 4 x 5 teeth 26 mm</p>  <p>ADSON-BABY 07-711 16 cm, 6 1/4" sharp 3 x 4 teeth 13 mm.</p>  <p>ADSON-BABY 07-712 16 cm, 6 1/4" blunt 3 x 4 teeth 13 mm</p>
1538	80	HMI-GS-1525	ADSON-BABY 16 cm, 6 1/4" sharp 3 x 4 teeth 13 mm	
1539	80	HMI-GS-1526	ADSON-BABY 16 cm, 6 1/4" blunt 3 x 4 teeth 13 mm	

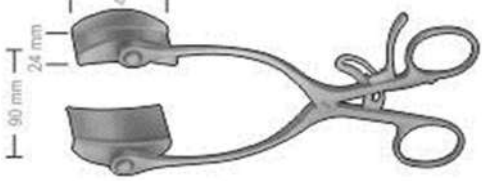
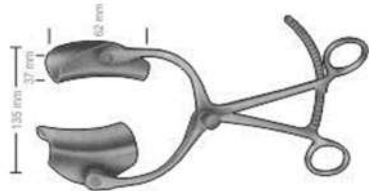


1540	81	HMI-GS-1527	PLESTER 11 cm, 4 ½" Fig. 1 Blunt	<p>07-720 11 cm, 4 ½" fig. 1 Blunt</p>
1541	81	HMI-GS-1528	PLESTER 11 cm, 4 ½" Fig. 2 Blunt	
1542	81	HMI-GS-1529	GELPI Vaginal Retractor 13.5 cm, 5"	
1543	81	HMI-GS-1530	GELPI Skin- and Vaginal Retractor 17.5 cm, 7"	
1544	81	HMI-GS-1531	CLOWARD modif. Spreader Only	<p>110 mm</p>
1545	81	HMI-GS-1532	CLOWARD modif.	<p>40 mm 16 mm 07-751</p>
1546	81	HMI-GS-1533	CLOWARD modif.	<p>45 mm 16 mm 07-752</p>
1547	81	HMI-GS-1534	CLOWARD modif.	<p>40 mm 16 mm 07-753</p>







1548	81	HMI-GS-1535	CLOWARD modif.	
1549	81	HMI-GS-1536	CLOWARD modif.	
1550	81	HMI-GS-1537	CLOWARD modif.	
1551	81	HMI-GS-1538	CLOWARD modif.	
1552	81	HMI-GS-1539	CLOWARD modif.	
1553	81	HMI-GS-1540	CLOWARD modif.	
1554	81	HMI-GS-1541	CLOWARD modif.	
1555	82	HMI-GS-1542	GOSSET Center Blades 40 x 30 mm	

1556	82	HMI-GS-1543	GOSSET Lateral Blades 58 mm deep Center blade 59 x 57 mm	
1557	82	HMI-GS-1544	GOSSET Blades:55mm deep	
1558	82	HMI-GS-1545	GOSSET Blades:38 mm deep	
1559	82	HMI-GS-1546	HERTZLER Blades 20 x 25 mm	
1560	83	HMI-GS-1547	BALFOUR Lateral blades 60 mm deep Center blade 47 x 80 mm	
1561	83	HMI-GS-1548	BALFOUR Lateral blades 105 mm deep Center blade 107 x 59 mm	
1562	83	HMI-GS-1549	Center blade only 54 x 80 mm	
1563	83	HMI-GS-1550	BALFOUR Spreader only	
1564	83	HMI-GS-1551	BALFOUR 50 mm 47 x 80 mm	

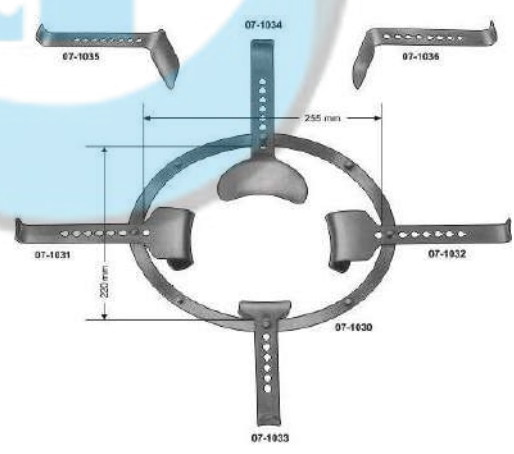
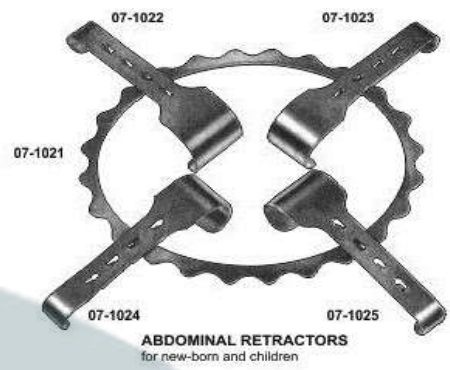
1565	83	HMI-GS-1552	BALFOUR 60 mm 62 x 76 mm	 <p>BALFOUR 07-430 Spreader only</p> <table border="1"> <tr> <td>07-851</td> <td>50 mm</td> <td>07-852</td> <td>60 mm</td> <td>07-853</td> <td>75 mm</td> <td>07-854</td> <td>90 mm</td> </tr> <tr> <td></td> <td>47 x 80 mm</td> <td></td> <td>62 x 76 mm</td> <td></td> <td>80 x 80 mm</td> <td></td> <td>80 x 83 mm</td> </tr> </table>	07-851	50 mm	07-852	60 mm	07-853	75 mm	07-854	90 mm		47 x 80 mm		62 x 76 mm		80 x 80 mm		80 x 83 mm
07-851	50 mm	07-852	60 mm		07-853	75 mm	07-854	90 mm												
	47 x 80 mm		62 x 76 mm			80 x 80 mm		80 x 83 mm												
1566	83	HMI-GS-1553	BALFOUR 75 mm 80 x 80 mm																	
1567	83	HMI-GS-1554	BALFOUR 90 mm 80 x 80 mm																	
1568	84	HMI-GS-1555	O'SULLIVAN/O'CONNOR (Set includes frame & 3 blades)																	
1569	84	HMI-GS-1556	O'SULLIVAN/O'CONNOR Frame Only (not pictured)																	
1570	84	HMI-GS-1557	O'SULLIVAN/O'CONNOR Single Retractor Blade 110 x 70 mm																	
1571	84	HMI-GS-1558	O'SULLIVAN/O'CONNOR Set of 2 Retractor Blade 80 x 45 mm																	
1572	84	HMI-GS-1559	COLLIN Complete																	
1573	84	HMI-GS-1560	COLLIN Spreader only																	
1574	84	HMI-GS-1561	COLLIN Blades 55 x 25 mm																	
1575	84	HMI-GS-1562	COLLIN Blades 80 x 25 mm																	
1576	84	HMI-GS-1563	COLLIN Center Blade 115 x 45 mm																	


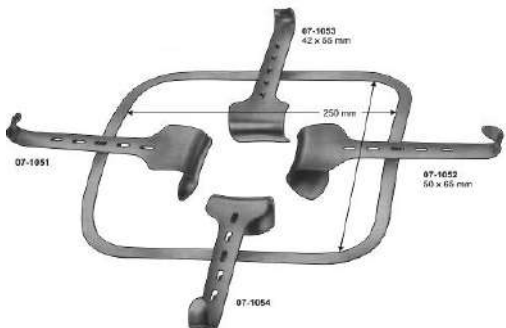



1577	84	HMI-GS-1564	Center Blade 45 x 80 mm 70 x 85 mm	
1578	84	HMI-GS-1565	Center Blade 100 x 60 mm	
1579	84	HMI-GS-1566	SCOVILLE-RICHTER Complete with 1 pair blades.	
1580	84	HMI-GS-1567	SCOVILLE-RICHTER Frame only.	
1581	84	HMI-GS-1568	SCOVILLE-RICHTER 62 x 52 mm, 62 x 37 mm	
1582	84	HMI-GS-1569	SCOVILLE-RICHTER 47 x 51 mm	
1583	84	HMI-GS-1570	SCOVILLE-RICHTER 30 x 40 mm	
1584	84	HMI-GS-1571	SCOVILLE-RICHTER 37 x 62 mm	









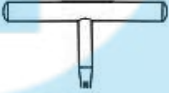

1585	85	HMI-GS-1572	BABY-COLLIN with 2 pair of blades	
1586	85	HMI-GS-1573	COLLIN complete	
1587	85	HMI-GS-1574	COLLIN Spreader Only	
1588	85	HMI-GS-1575	COLLIN Lateral blade 37x62mm	
1589	85	HMI-GS-1576	COLLIN Center blade 54x55mm	
1590	85	HMI-GS-1577	COLLIN Lateral blade 37x80mm	
1591	85	HMI-GS-1578	COLLIN Center blade 54x67mm	
1592	85	HMI-GS-1579	COLLIN Lateral blade 37x98mm	
1593	85	HMI-GS-1580	COLLIN Center blade 52x76mm	
1594	85	HMI-GS-1581	RICARD Complete	
1595	85	HMI-GS-1582	RICARD Spreader only	
1596	85	HMI-GS-1583	Lateral blade 58x80mm	
1597	85	HMI-GS-1584	Center blade 54x70mm	
1598	85	HMI-GS-1585	Lateral blade 72x84mm	






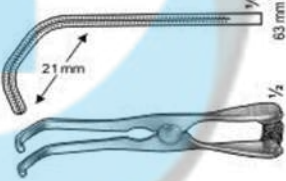
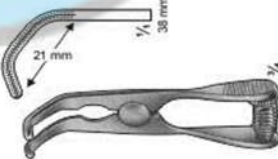


1599	85	HMI-GS-1586	Center blade 72x90mm	
1600	85	HMI-GS-1587	HOLZBACH Complete	
1601	85	HMI-GS-1588	HOLZBACH Spreader only	
1602	85	HMI-GS-1589	HOLZBACH Lateral blade 59x80mm	
1603	85	HMI-GS-1590	HOLZBACH Center blade 74x82mm	
1604	85	HMI-GS-1591	COLLIN 20 cm, 8" complete with 2 lateral blades and central blade	
1605	85	HMI-GS-1592	LEGUEU 17 cm, 6 3/4"	
1606	85	HMI-GS-1593	DOYEN 48 mm x 90 mm 28 cm , 11"	
1607	85	HMI-GS-1594	DOYEN 48 mm x 105 mm 28 cm , 11"	
1608	85	HMI-GS-1595	DOYEN 48 mm x 120 mm 28 cm , 11"	
1609	85	HMI-GS-1596	DOYEN 48 mm x 135 mm 28 cm , 11"	
1610	85	HMI-GS-1597	ROCHARD 48 mm x 90 mm 31 cm, 12"	
1611	85	HMI-GS-1598	ROCHARD 48 mm x 105 mm 31 cm, 12"	
1612	85	HMI-GS-1599	ROCHARD 48 mm x 120 mm 31 cm, 12"	


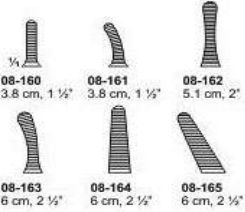

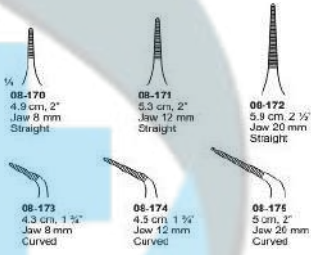

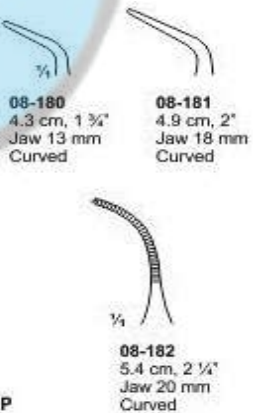
1613	85	HMI-GS-1600	ROCHARD 48 mm x 135 mm 31 cm, 12"
1614	85	HMI-GS-1601	ROCHARD 48 mm x 155 mm 31 cm, 12"
1615	86	HMI-GS-1602	DENIS-BROWNE Complete with 4 blades
1616	86	HMI-GS-1603	DENIS-BROWNE Frame 190 x 160 mm
1617	86	HMI-GS-1604	DENIS-BROWNE 2 blades only 40 x 30 mm
1618	86	HMI-GS-1605	DENIS-BROWNE 2 blades only 40 x 40 mm
1619	86	HMI-GS-1606	DENIS-BROWNE Blades only 20 x 30 mm
1620	86	HMI-GS-1607	DENIS-BROWNE Blades only 20 x 40 mm
1621	86	HMI-GS-1608	SEMM consisting of: 1 frame 225 x 220 mm
1622	86	HMI-GS-1609	SEMM consisting of: 1 blade 46 x 64 mm
1623	86	HMI-GS-1610	SEMM consisting of: 1 blade 46 x 64 mm
1624	86	HMI-GS-1611	SEMM consisting of: 1 blade 53 x 54 mm (for bladder)
1625	86	HMI-GS-1612	SEMM consisting of: 1 blade 82 x 97 mm (for intestine)
1626	86	HMI-GS-1613	SEMM consisting of: 1 blade 98 x 51 mm (for intestine)
1627	86	HMI-GS-1614	SEMM consisting of: 1 blade, narrow 107 x 36 mm









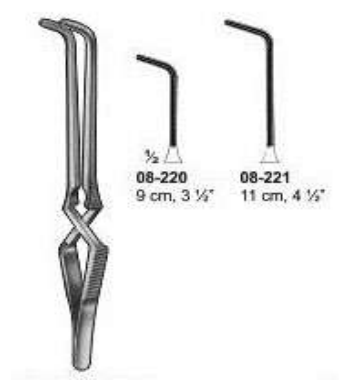
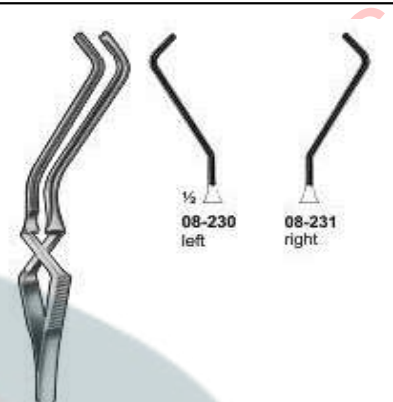
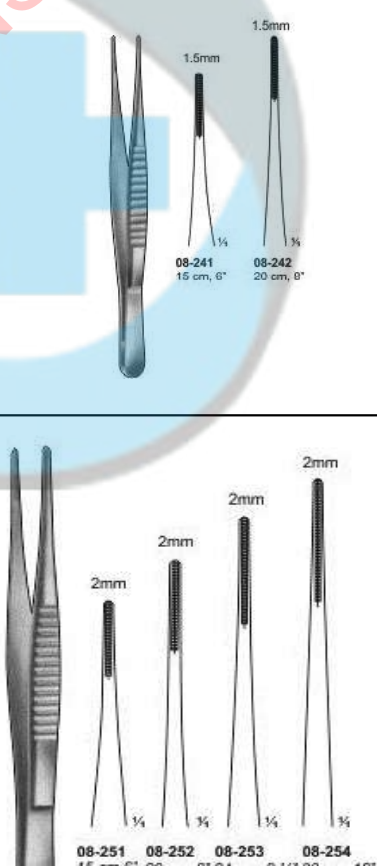
1628	87	HMI-GS-1615	KIRSCHNER with folding frame & 2 blades of each 07-1051, 07-1052 & 07-1053, 07-1054	
1629	87	HMI-GS-1616	KIRSCHNER with vaulted fixed frame & 2 blades of each 07-1051, 07-1052 & 07-1053, 07-1054	
1630	87	HMI-GS-1617	KIRSCHNER 300 x 380 mm Frame only, over-sized	
1631	87	HMI-GS-1618	KIRSCHNER 320 x 300 mm Frame only	
1632	87	HMI-GS-1619	KIRSCHNER 64 x 80 mm	
1633	87	HMI-GS-1620	KIRSCHNER-BALFOUR 80 x 82 mm	
1634	87	HMI-GS-1621	KIRSCHNER 90 x 69 mm	
1635	87	HMI-GS-1622	KIRSCHNER 92 x 95 mm	
1636	87	HMI-GS-1623	KIRSCHNER 78 x 58 mm	
1637	87	HMI-GS-1624	KIRSCHNER 108 x 42 mm	













1638	87	HMI-GS-1625	KIRSCHNER 91 x 55 mm	
1639	87	HMI-GS-1626	KIRSCHNER 121 x 55 mm	
1640	CARDIVASCULAR			
1641				
1642	88	HMI-GS-1627	NABATOFF varicose vein probe set complete	  08-101 Plastic Probe tip  08-102 3 mm Ø Olive  08-103 6 mm Ø Olive  08-104 9 mm Ø Olive  08-105 12 mm Ø Olive  08-106 15 mm Ø Olive  08-107 Handle, T-form  08-108 TRACTION CABLE 90 cm, 36"
1643	88	HMI-GS-1628	NABATOFF Plastic Probe tip	
1644	88	HMI-GS-1629	NABATOFF 3 mm Ø Olive	
1645	88	HMI-GS-1630	NABATOFF 6 mm Ø Olive	
1646	88	HMI-GS-1631	NABATOFF 9 mm Ø Olive	
1647	88	HMI-GS-1632	NABATOFF 12 mm Ø Olive	
1648	88	HMI-GS-1633	NABATOFF 15 mm Ø Olive	
1649	88	HMI-GS-1634	Handle, T-form	
1650	88	HMI-GS-1635	TRACTION CABLE 90 cm, 36"	
1651	88	HMI-GS-1636	COOLEY Atraumatic Bulldog Clamp 5.0 cm, 2"	
1652	88	HMI-GS-1637	COOLEY Atraumatic Bulldog Clamp 5.5 cm, 2 5/8"	





1653	88	HMI-GS-1638	COOLEY Atraumatic Bulldog Clamp 9.5 cm, 3 3/8"	
1654	88	HMI-GS-1639	COOLEY Atraumatic Bulldog Clamp 12.5 cm, 5"	
1655	88	HMI-GS-1640	DE BAKEY ATRAUMATIC MIN 5.0 cm, 2" Jaw Length 27 mm Straight	
1656	88	HMI-GS-1641	DE BAKEY ATRAUMATIC MIN 5.0 cm, 2" Jaw Length 27 mm Curved	
1657	88	HMI-GS-1642	DE BAKEY ATRAUMATIC MIN 10 cm, 4" Jaw Length 54 mm S-Ship	
1658	88	HMI-GS-1643	DE BAKEY ATRAUMATIC MIN 10 cm, 4" Jaw Length 63 mm Multi	
1659	88	HMI-GS-1644	DE BAKEY ATRAUMATIC MIN 7 cm, 2 3/4" Jaw Length 38 mm Multi	
1660	89	HMI-GS-1645	DIEFFENBACH 3.8 cm, 1 1/2"	
1661	89	HMI-GS-1646	DIEFFENBACH 3.8 cm, 1 1/2"	

1662	89	HMI-GS-1647	DIEFFENBACH 5.1 cm, 2"	  08-160 3.8 cm, 1 1/2" 08-161 3.8 cm, 1 1/2" 08-162 5.1 cm, 2" 08-163 6 cm, 2 1/2" 08-164 6 cm, 2 1/2" 08-165 6 cm, 2 1/2"
1663	89	HMI-GS-1648	DIEFFENBACH 6 cm, 2 1/2"	
1664	89	HMI-GS-1649	DIEFFENBACH 6 cm, 2 1/2"	
1665	89	HMI-GS-1650	DIEFFENBACH 6 cm, 2 1/2"	
1666	89	HMI-GS-1651	DIETHRICH 4.9 cm, 2 Jaw 8 mm Straight	
1667	89	HMI-GS-1652	DIETHRICH 5.3 cm, 2" Jaw 12 mm Straight	  08-170 4.9 cm, 2" Jaw 8 mm Straight 08-171 5.3 cm, 2" Jaw 12 mm Straight 08-172 5.3 cm, 2 1/2" Jaw 20 mm Straight 08-173 4.3 cm, 1 3/4" Jaw 8 mm Curved 08-174 4.5 cm, 1 3/4" Jaw 12 mm Curved 08-175 5 cm, 2" Jaw 20 mm Curved
1668	89	HMI-GS-1653	DIETHRICH 5.9 cm, 2 1/2" Jaw 20 mm Straight	
1669	89	HMI-GS-1654	DIETHRICH 4.3 cm, 1 3/4" Jaw 8 mm Curved	
1670	89	HMI-GS-1655	DIETHRICH 4.5 cm, 1 3/4" Jaw 12 mm Curved	
1671	89	HMI-GS-1656	DIETHRICH 5 cm, 2" Jaw 20 mm Curved	
1672	89	HMI-GS-1657	BULLDOG CLAMP 4.3 cm, 1 3/4" Jaw 13 mm Curved	  08-180 4.3 cm, 1 3/4" Jaw 13 mm Curved 08-181 4.9 cm, 2" Jaw 18 mm Curved 08-182 5.4 cm, 2 1/4" Jaw 20 mm Curved
1673	89	HMI-GS-1658	BULLDOG CLAMP 4.9 cm, 2" Jaw 18 mm Curved	
1674	89	HMI-GS-1659	BULLDOG CLAMP 5.4 cm, 2 1/4" Jaw 20 mm Curved	

1675	89	HMI-GS-1660	JOHNS-HOPKINS 3.8 cm, 1 1/2"	
1676	89	HMI-GS-1661	JOHNS-HOPKINS 5.0 cm, 2"	
1677	89	HMI-GS-1662	JOHNS-HOPKINS 5.5 cm, 2 1/8"	
1678	89	HMI-GS-1663	JOHNS-HOPKINS 6.0 cm, 2 1/2"	
1679	89	HMI-GS-1664	JOHNS-HOPKINS 7.0 cm, 2 3/4"	
1680	89	HMI-GS-1665	JOHNS-HOPKINS 8.0 cm, 3 1/8"	
1681	89	HMI-GS-1666	JOHNS-HOPKINS 8.5 cm, 3 1/2"	  08-200 8 cm, 3 1/4" Jaw 20 mm Straight  08-201 9 cm, 3 1/2" Jaw 30 mm Straight  08-202 10.5 cm, 4" Jaw 45 mm Straight  08-203 12.5 cm, 5" Jaw 68 mm Straight DEBAKEY
1682	89	HMI-GS-1667	DEBAKEY 8 cm, 3 1/4" Jaw 20 mm Straight	
1683	89	HMI-GS-1668	DEBAKEY 9 cm, 3 1/2" Jaw 30 mm Straight	
1684	89	HMI-GS-1669	DEBAKEY 10.5 cm, 4" Jaw 45 mm Straight	
1685	89	HMI-GS-1670	DEBAKEY 12.5 cm, 5" Jaw 68 mm Straight	
1686	89	HMI-GS-1671	DEBAKEY 7.5 cm, 3" Jaw 20 mm Curved	
1687	89	HMI-GS-1672	DEBAKEY 8.5 cm, 3 1/2" Jaw 30 mm Curved	
1688	89	HMI-GS-1673	DEBAKEY 9.5 cm, 3 3/4" Jaw 45 mm Curved	
1689	89	HMI-GS-1674	DEBAKEY 11.5 cm, 4 3/4" Jaw 68 mm Curved	

1690	89	HMI-GS-1675	GREGORY-SOFT 9 cm, 3 1/2"	 <p>08-220 9 cm, 3 1/2"</p> <p>08-221 11 cm, 4 1/2"</p>
1691	89	HMI-GS-1676	GREGORY-SOFT 11 cm, 4 1/2"	
1692	89	HMI-GS-1677	GREGORY-SOFT 11 cm, 4 1/2" left	 <p>08-230 left</p> <p>08-231 right</p>
1693	89	HMI-GS-1678	GREGORY-SOFT 11 cm, 4 1/2" right	
1694	90	HMI-GS-1679	DE BAKEY 15 cm, 6"	 <p>1.5mm</p> <p>1.5mm</p> <p>08-241 15 cm, 6"</p> <p>08-242 20 cm, 8"</p> <p>2mm</p> <p>2mm</p> <p>2mm</p> <p>2mm</p> <p>08-251</p> <p>08-252</p> <p>08-253</p> <p>08-254</p>
1695	90	HMI-GS-1680	DE BAKEY 20 cm, 8"	
1696	90	HMI-GS-1681	DE BAKEY	
1697	90	HMI-GS-1682	DE BAKEY 15 cm 6"	
1698	90	HMI-GS-1683	DE BAKEY 20 cm, 8"	
1699	90	HMI-GS-1684	DE BAKEY 24 cm, 9 1/2"	

1700	90	HMI-GS-1685	DE BAKEY 30 cm, 12"		15 cm 6" 20 cm, 8" 24 cm, 9 1/2" 30 cm, 12"
1701	90	HMI-GS-1686	DE BAKEY	    08-261 08-262 08-263 08-264 15 cm 6" 20 cm, 8" 24 cm, 9 1/2" 30 cm, 12"	
1702	90	HMI-GS-1687	DE BAKEY 15 cm 6"		
1703	90	HMI-GS-1688	DE BAKEY 20 cm, 8"		
1704	90	HMI-GS-1689	DE BAKEY 24 cm, 9 1/2"		
1705	90	HMI-GS-1690	DE BAKEY 30 cm, 12"		
1706	90	HMI-GS-1691	DE BAKEY	   08-271 08-272 08-273 20 cm, 8" 24 cm, 9 1/2" 30 cm, 12"	
1707	90	HMI-GS-1692	DE BAKEY 20 cm, 8"		
1708	90	HMI-GS-1693	DE BAKEY 24 cm, 9 1/2"		
1709	90	HMI-GS-1694	DE BAKEY 30 cm, 12"		
1710	90	HMI-GS-1695	DE BAKEY	  08-281 15 cm, 6"	
1711	90	HMI-GS-1696	DE BAKEY 15 cm, 6"		
1712	90	HMI-GS-1697	DE BAKEY	 DE BAKEY 08-300 	

1713	90	HMI-GS-1698	DE BAKEY 20 cm, 8"	
1714	91	HMI-GS-1699	DEBAKEY 15 cm	
1715	91	HMI-GS-1700	DEBAKEY 20 cm	
1716	91	HMI-GS-1701	DEBAKEY 24 cm	
1717	91	HMI-GS-1702	DEBAKEY 30 cm	
1718	91	HMI-GS-1703	DEBAKEY 15 cm	
1719	91	HMI-GS-1704	DEBAKEY 20 cm	
1720	91	HMI-GS-1705	DEBAKEY 24 cm	
1721	91	HMI-GS-1706	DEBAKEY 30 cm	
1722	91	HMI-GS-1707	COOLEY 15 cm	
1723	91	HMI-GS-1708	COOLEY 20 cm	
1724	91	HMI-GS-1709	COOLEY 24 cm	
1725	91	HMI-GS-1710	COOLEY 30 cm	
1726	91	HMI-GS-1711	DE BAKEY 18 cm, 7"	
1727	91	HMI-GS-1712	DE BAKEY 21 cm, 8 1/4"	
1728	91	HMI-GS-1713	DE BAKEY 18 cm, 7"	



2.7 mm
3/4



3.5 mm
3/4



2 mm
3/4

1.2 mm
3/4

08-330 18 cm, 7"
08-301 21 cm, 8 1/4"

2 mm
3/4

1729	91	HMI-GS-1714	DE BAKEY 21 cm, 8 ¼"
1730	91	HMI-GS-1715	DE BAKEY 16 cm, 6 ½" 1.5 mm
1731	91	HMI-GS-1716	DE BAKEY 20 cm, 8" 1.5 mm
1732	91	HMI-GS-1717	DE BAKEY 24 cm, 9 ½" 1.5 mm
1733	91	HMI-GS-1718	DE BAKEY 16 cm, 6 ½" 2.7mm
1734	91	HMI-GS-1719	DE BAKEY 20 cm, 8" 2.7mm
1735	91	HMI-GS-1720	DE BAKEY 20 cm, 8" 2.7mm Heavy
1736	91	HMI-GS-1721	DE BAKEY 24 cm, 9 ½" 2.7mm
1737	91	HMI-GS-1722	DE BAKEY 30.5 cm, 12" 2.7mm
1738	91	HMI-GS-1723	DE BAKEY 16 cm, 6 ½" 2.0mm
1739	91	HMI-GS-1724	DE BAKEY 20 cm, 8" 2.0mm
1740	91	HMI-GS-1725	DE BAKEY 24 cm, 9 ½" 2.0mm
1741	91	HMI-GS-1726	DE BAKEY 30.5 cm, 12" 2.0mm
1742	91	HMI-GS-1727	DE BAKEY 16 cm, 6 ½" 3.5mm
1743	91	HMI-GS-1728	DE BAKEY 20 cm, 8" 3.5mm
1744	91	HMI-GS-1729	DE BAKEY 24 cm, 9 ½" 3.5mm



08-332 18 cm, 7"
08-303 21 cm, 8 ¼"



08-340 16 cm, 6 ½" 1.5 mm
08-341 20 cm, 8" 1.5 mm
08-342 24 cm, 9 ½" 1.5 mm



08-343 16 cm, 6 ½" 2.0mm
08-344 20 cm, 8" 2.0mm
08-345 24 cm, 9 ½" 2.0mm
08-346 30.5 cm, 12" 2.0mm


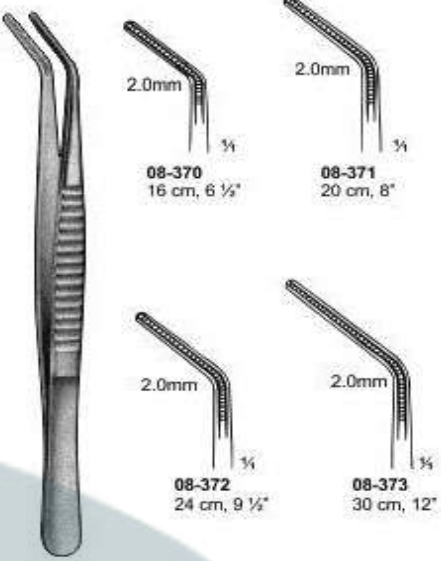
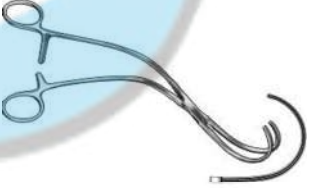
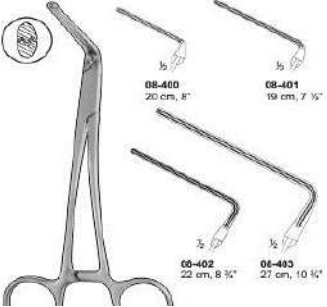




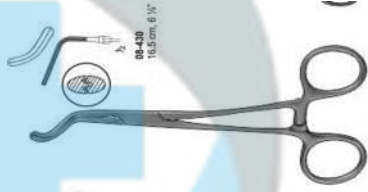
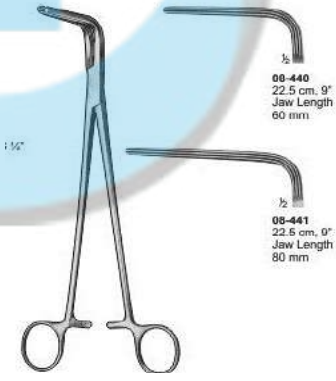

08-347 16 cm, 6 ½" 2.7mm
08-348 20 cm, 8" 2.7mm
08-349 20 cm, 8" 2.7mm
08-350 24 cm, 9 ½" 2.7mm
08-351 30.5 cm, 12" 2.7mm



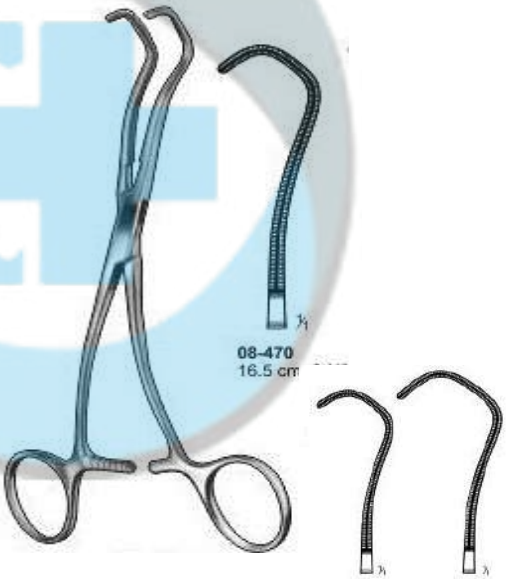








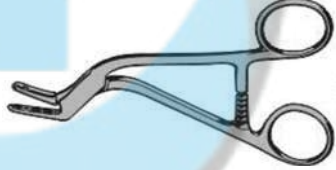

08-352 16 cm, 6 ½" 3.5mm
08-353 20 cm, 8" 3.5mm
08-354 24 cm, 9 ½" 3.5mm
08-355 30.5 cm, 12" 3.5mm







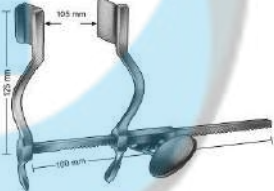












1745	91	HMI-GS-1730	DE BAKEY 30.5 cm, 12" 3.5mm	
1746	91	HMI-GS-1731	DE BAKEY 16 cm, 6 1/2"	
1747	91	HMI-GS-1732	DE BAKEY 20 cm, 8"	
1748	91	HMI-GS-1733	DE BAKEY 24 cm, 9 1/2"	
1749	91	HMI-GS-1734	DE BAKEY 30 cm, 12"	
1750	92	HMI-GS-1735	WEBER 26 cm, 10 1/4" left	
1751	92	HMI-GS-1736	WEBER 26 cm, 10 1/4" right	
1752	92	HMI-GS-1737	DE BAKEY Right Angled Jaws 20 cm, 8"	
1753	92	HMI-GS-1738	DE BAKEY Right Angled Jaws 19 cm, 7 1/2"	
1754	92	HMI-GS-1739	DE BAKEY Right Angled Jaws 22 cm, 8 3/4"	





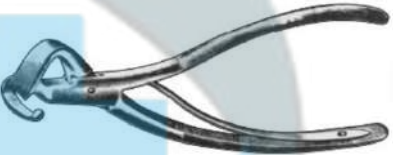



1755	92	HMI-GS-1740	DE BAKEY Right Angled Jaws 27 cm, 10 3/4"	
1756	92	HMI-GS-1741	DE BAKEY 19 cm, 7 1/2"	
1757	92	HMI-GS-1742	DE BAKEY 25 cm, 10"	
1758	92	HMI-GS-1743	DE BAKEY 25 cm, 10"	
1759	92	HMI-GS-1744	DE BAKEY 25 cm, 10"	
1760	92	HMI-GS-1745	DE BAKEY 27 cm, 10 3/4"	
1761	93	HMI-GS-1746	KAY 20 cm, 8"	
1762	93	HMI-GS-1747	SUBRAMANIAN 16.5 cm, 6 1/2"	
1763	93	HMI-GS-1748	BRONCHUS FORCEPS 22.5 cm, 9" Jaw Length 60 mm	
1764	93	HMI-GS-1749	22.5 cm, 9" Jaw Length 80 mm	
1765	93	HMI-GS-1750	SAROT 23cm	


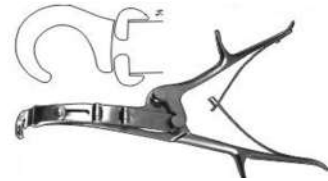

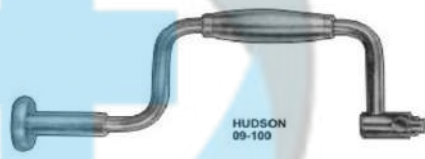



1766	93	HMI-GS-1751	SAROT 23cm	
1767	93	HMI-GS-1752	SATINSKY Fig 1 15cm	
1768	93	HMI-GS-1753	SATINSKY Fig 2 26cm	
1769	93	HMI-GS-1754	SATINSKY Fig 3 26cm	
1770	94	HMI-GS-1755	DERRA 16.5 cm, 6 1/2"	
1771	94	HMI-GS-1756	DERRA 17 cm, 6 3/4"	
1772	94	HMI-GS-1757	DERRA 18 cm, 7"	
1773	94	HMI-GS-1758	PRICE-THOMAS 22cm	








1774	94	HMI-GS-1759	WANGENSTEEN 28cm	
1775	94	HMI-GS-1760	LOVELACE 20cm	
1776	94	HMI-GS-1761	LOVELACE 20cm	
1777	94	HMI-GS-1762	HARRINGTON ROCHESTER 30cm	
1778	95	HMI-GS-1763	DAVIDSON 23cm	
1779	95	HMI-GS-1764	ADSON 15cm	
1780	95	HMI-GS-1765	BLALOCK 15cm	 <p>¼ 08-550</p> <p>08-551</p>
1781	95	HMI-GS-1766	BLALOCK 20cm	









1782	95	HMI-GS-1767	BLALOCK 20cm		 08-552
1783	95	HMI-GS-1768	BAILEY-GIBBON 20 cm, 8" For Adult		 08-561 20 cm, 8" For children
1784	95	HMI-GS-1769	BAILEY-GIBBON 20 cm, 8" For children		
1785	95	HMI-GS-1770	BAILEY-BABY 08-570 15 cm, 6"		
1786	95	HMI-GS-1771	SELLORS RIB CONTRACTOR 20 cm, 8"		
1787	96	HMI-GS-1772	HERTZLER blades 20 x 25 mm, spreading 105 mm		
1788	96	HMI-GS-1773	TUFFIER blades 43 x 53 mm, spreading 130 mm		
1789	96	HMI-GS-1774	FINOCCHIETTO 20 cm, 8"		
1790	96	HMI-GS-1775	FINOCCHIETTO 20 cm, 8" 30 mm x 45 mm spreading 150 mm		





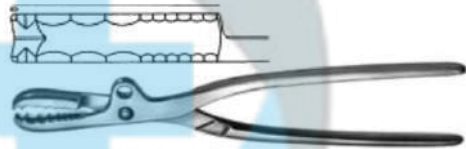



1791	96	HMI-GS-1776	FINOCCHIETTO 20 cm, 8" 46 mm x 62 mm spreading 190 mm	
1792	96	HMI-GS-1777	FINOCCHIETTO 20 cm, 8" 80 mm x 65 mm spreading 190 mm	
1793	96	HMI-GS-1778	TUFFIER RIB RETRACTOR lateral blades 45 x 45 mm, spreading 160 mm	
1794	97	HMI-GS-1779	SAUERBRUCH-FREY for the first rib 37 cm, 14 1/2"	
1795	97	HMI-GS-1780	SCHUMACHER sternum shears 21 cm, 8 1/4"	
1796	97	HMI-GS-1781	SAUERBRUCH 24 cm, 9 1/2" For Children,	
1797	97	HMI-GS-1782	SAUERBRUCH 27 cm, 10 3/4" For Adults,	
1798	97	HMI-GS-1783	SCHUARDT 17 cm, 6 3/4"	
1799	97	HMI-GS-1784	BONE SHEAR 23 cm, 9"	






1800	97	HMI-GS-1785	BONE SHEAR 19 cm, 7 ¼"	
1801	97	HMI-GS-1786	RIB SHEAR 23 cm, 9"	
1802	97	HMI-GS-1787	GLUCK RIB SHEAR 22 cm, 8 ¾"	
1803	97	HMI-GS-1788	COLLIN 19 cm, 7 ¼"	
1804	98	HMI-GS-1789	DOYEN 19 cm, 7 ¼"	
1805	98	HMI-GS-1790	LEBSCHKE STERNUM CHISEL 24.5 cm, 9 ¾"	
1806	98	HMI-GS-1791	SEMB 20 cm, 8"	
1807	98	HMI-GS-1792	SEMB 20 cm, 8"	




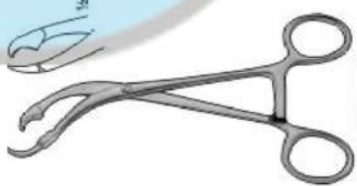

1808	98	HMI-GS-1793	GIERTZ-STILLE 27 cm, 10 1/2"	
1809	98	HMI-GS-1794	BRUNNER 33.5 cm, 13"	
1810	98	HMI-GS-1795	MAURER-COLLIN Hooked Left 23 cm, 9"	
1811	98	HMI-GS-1796	MAURER-COLLIN Hooked Right 23 cm, 9"	
1812 1813	ORTHODONTIC INSTRUMENTS			
1814	99	HMI-GS-1797	HUDSON BONE DRILLS	
1815	99	HMI-GS-1798	Fig. 1	
1816	99	HMI-GS-1799	Fig. 2	
1817	99	HMI-GS-1800	Fig. 3	



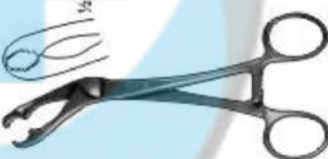

1818	99	HMI-GS-1801	CUSHING	
1819	99	HMI-GS-1802	CUSHING	
1820	99	HMI-GS-1803	GIGLI SAW 30 mm stainless	
1821	99	HMI-GS-1804	GIGLI SAW 40 mm stainless	
1822	99	HMI-GS-1805	GIGLI SAW 50 mm stainless	
1823	99	HMI-GS-1806	GIGLI SAW 70 mm stainless	
1824	99	HMI-GS-1807	GIGLI HANDLE	
1825	99	HMI-GS-1808	ENGEL PLASTER SAW 15.5 cm, 6"	
1826	99	HMI-GS-1809	POST MORTEN 20 cm, 8"	
1827	99	HMI-GS-1810	CHARRIERE Double saw 25 cm, 10"	






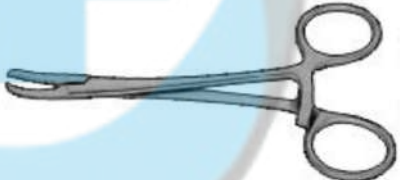

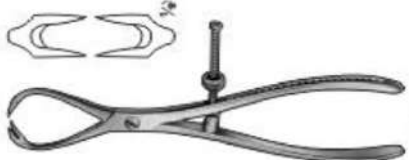
1828	99	HMI-GS-1811	CHARRIERE Double saw 27 cm, 10 3/4"	
1829	99	HMI-GS-1812	CHARRIERE 27 cm, 10 3/4"	
1830	99	HMI-GS-1813	CHARRIERE 30 cm, 12"	
1831	99	HMI-GS-1814	CHARRIERE 35 cm, 13 3/4"	
1832	99	HMI-GS-1815	SATTERLEE 31cm, 12 1/4"	
1833	99	HMI-GS-1816	PERCY RETRACTOR	
1834	100	HMI-GS-1817	SEQUESTRUM 27cm	  
1835	100	HMI-GS-1818	SEQUESTRUM 29cm	


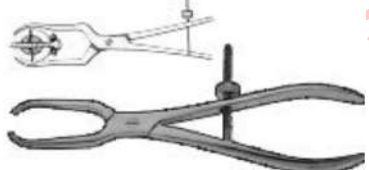



1836	100	HMI-GS-1819	VAN BUREN 27cm	
1837	100	HMI-GS-1820	FERGUSSON BONE HOLDING FORCEPS 21cm heavy pattern	
1838	100	HMI-GS-1821	LANGENBECK BONE HOLDING FORCEPS 21cm	
1839	100	HMI-GS-1822	SEMB BONE HOLDING FORCEPS 19cm curved sideways	
1840	100	HMI-GS-1823	FARABEUF BONE HOLDING FORCEPS 23cm	
1841	100	HMI-GS-1824	FARABEUF BONE HOLDING FORCEPS 26cm	
1842	100	HMI-GS-1825	FARABEUF BONE HOLDING FORCEPS 26cm	
1843	101	HMI-GS-1826	Lane Bone Holding Forceps 31.5cm	

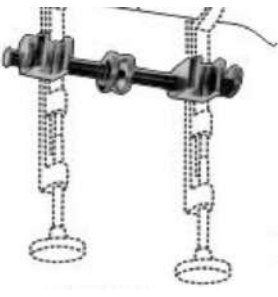
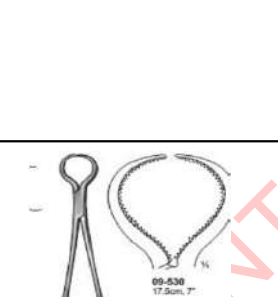
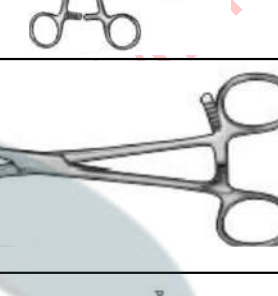
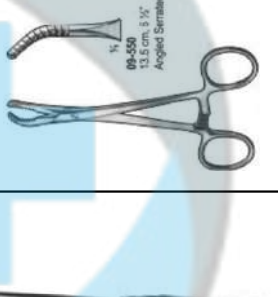



1844	101	HMI-GS-1827	Lane Bone Holding Forceps 39cm	
1845	101	HMI-GS-1828	Lane Bone Holding Forceps 33cm	
1846	101	HMI-GS-1829	Lane Bone Holding Forceps 45cm	
1847	101	HMI-GS-1830	Kern Bone Holding Forceps 17cm	
1848	101	HMI-GS-1831	Kern Bone Holding Forceps 21cm	
1849	101	HMI-GS-1832	Kern Bone Holding Forceps 17cm	
1850	101	HMI-GS-1833	Kern Bone Holding Forceps 21cm	
1851	101	HMI-GS-1834	Lambotte Bone Holding Forceps 19cm	








1852	101	HMI-GS-1835	Lambotte Bone Holding Forceps 23cm	
1853	101	HMI-GS-1836	Lambotte Bone Holding Forceps 26cm	
1854	101	HMI-GS-1837	Lambotte Bone Holding Forceps 22cm	
1855	101	HMI-GS-1838	Lambotte Bone Holding Forceps 26cm	
1856	101	HMI-GS-1839	Lambotte Bone Holding Forceps 33cm	
1857	101	HMI-GS-1840	VERBRUGGE 18 cm, 7"	
1858	101	HMI-GS-1841	VERBRUGGE 18 cm, 7"	
1859	101	HMI-GS-1842	VERBRUGGE 25 cm, 10"	


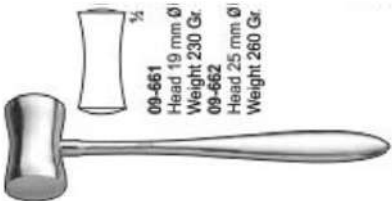



1860	101	HMI-GS-1843	VERBRUGGE 26 cm, 10 ¼ "	
1861	101	HMI-GS-1844	VERBRUGGE 27 cm, 10 ½"	
1862	101	HMI-GS-1845	VERBRUGGE 25 cm, 10"	
1863	101	HMI-GS-1846	VERBRUGGE 26 cm, 10 ¼ "	
1864	101	HMI-GS-1847	VERBRUGGE 27 cm, 10 ½"	
1865	101	HMI-GS-1848	VERBRUGGE 18 cm, 7"	
1866	101	HMI-GS-1849	VERBRUGGE 25 cm, 10"	
1867	101	HMI-GS-1850	VERBRUGGE 26 cm, 10 ¼ "	


1868	101	HMI-GS-1851	VERBRUGGE 27 cm, 10 ½"	
1869	101	HMI-GS-1852	REIL 17 cm, 7"	
1870	101	HMI-GS-1853	REDUCTION FORCEPS 20 cm, 8" with Points	
1871	101	HMI-GS-1854	17 cm, 7" For fingers, with drill Guide for Kirschner Wires up to 1 mm	
1872	102	HMI-GS-1855	HOLDING FORCEPS 13 cm, 5"	
1873	102	HMI-GS-1856	RATCHET FIXATION FORCEPS 14.5 cm, 6"	
1874	102	HMI-GS-1857	MALLEOLAR FORCEPS 20 cm, 8"	
1875	102	HMI-GS-1858	PATELLA FORCEPS 18.5 cm, 7 ¼"	











1876	102	HMI-GS-1859	REDUCTION FORCEPS with Thread Lock 16 cm, 6 ½"	
1877	102	HMI-GS-1860	REDUCTION FORCEPS with Thread Lock 24 cm, 9 ½"	
1878	102	HMI-GS-1861	REPOSITION FORCEPS 23 cm, 9"	
1879	102	HMI-GS-1862	LOWMANN BONE CLAMP 18.0 cm, 7"	
1880	102	HMI-GS-1863	LOWMANN BONE CLAMP 20.0 cm, 8"	
1881	102	HMI-GS-1864	LOWMANN BONE CLAMP 22.0 cm, 8 ¾"	
1882	102	HMI-GS-1865	LOWMAN-HOGLUND 17.5 cm, 7"	
1883	102	HMI-GS-1866	GERSTER 18 cm, 7"	

1884	102	HMI-GS-1867	GERSTER 20 cm, 8"	
1885	102	HMI-GS-1868	GERSTER 22 cm, 9"	
1886	102	HMI-GS-1869	LEWIN 17.5cm, 7"	
1887	102	HMI-GS-1870	ORTHO FORCEPS 13 cm, 5"	
1888	102	HMI-GS-1871	ORTHO FORCEPS 13.5 cm, 5 1/2" Angled Serrated	
1889	103	HMI-GS-1872	MALLET 26 cm, 10 1/2"	
1890	103	HMI-GS-1873	MALLET 26 cm, 10 1/4"	
1891	103	HMI-GS-1874	MALLET 24 cm, 9 1/2"	

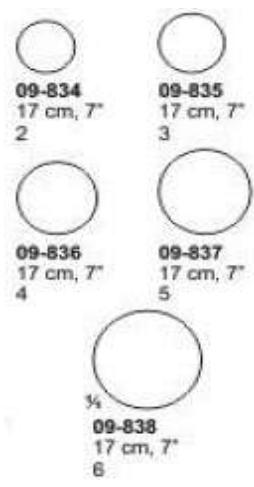
1892	103	HMI-GS-1875	MALLET 26 cm, 10 ¼"	
1893	103	HMI-GS-1876	MALLET 22.5 cm, 9"	
1894	103	HMI-GS-1877	MALLET 18 cm, 7"	
1895	103	HMI-GS-1878	MALLET 26 cm, 10 ¼"	
1896	103	HMI-GS-1879	MALLET 26 cm, 10 ¼"	
1897	103	HMI-GS-1880	WILLIGER 24 cm, 9 ½"	
1898	103	HMI-GS-1881	WILLIGER 24 cm, 9 ½" Head 26 mm Ø Weight 300 Gr.	
1899	103	HMI-GS-1882	WILLIGER 24 cm, 9 ½" Head 28 mm Ø Weight 340 Gr.	
1900	103	HMI-GS-1883	WILLIGER 24 cm, 9 ½" Head 30 mm Ø Weight 400 Gr.	
1901	103	HMI-GS-1884	DOYEN 21 cm, 8 ¼"	
1902	103	HMI-GS-1885	DOYEN 21 cm, 8 ¼" Head 25 mm Ø Weight 120 Gr.	

1903	103	HMI-GS-1886	DOYEN 21 cm, 8 ¼" Head 30 mm Ø Weight 180 Gr.	
1904	103	HMI-GS-1887	DOYEN 21 cm, 8 ¼" Head 35 mm Ø Weight 260 Gr.	
1905	103	HMI-GS-1888	LUCAE 19 cm, 7 ½"	
1906	103	HMI-GS-1889	LUCAE 19 cm, 7 ½" Head 19 mm Ø Weight 230 Gr.	
1907	103	HMI-GS-1890	LUCAE 19 cm, 7 ½" Head 25 mm Ø Weight 260 Gr.	
1908	103	HMI-GS-1891	WILLIGER 16.5 cm, 6 ½" Head 20 mm ø weight 140 Gr.	
1909	103	HMI-GS-1892	PARTSCH 18 cm, 7"	
1910	103	HMI-GS-1893	MEAD 17 cm, 6 ¾"	
1911	103	HMI-GS-1894	MEAD Spare Facings	
1912	103	HMI-GS-1895	MEAD 17 cm, 6 ¾" with interchangeable Plastic dicks Head 26 mm Ø Weight 320 Gr.	

1913	103	HMI-GS-1896	HERBERT 19 cm, 7 1/2"	
1914	103	HMI-GS-1897	VICKERS 19 cm, 7 3/4"	
1915	104	HMI-GS-1898	ORTHO / WITH PLASTIC CAPS 18 cm, 7" 25 mm Dia. (140g) Pair of spare disks with interchangeable plastic disks	
1916	104	HMI-GS-1899	ORTHO 26.5 cm, 10 1/2" (450g)	
1917	104	HMI-GS-1900	ORTHO PAEDIC MALLET 19 cm, 7 1/2"	
1918	104	HMI-GS-1901	HAJEK 22 cm, 8 3/4" 27 mm Dia. (140g)	
1919	104	HMI-GS-1902	ORTHO 26.5 cm (450g)	
1920	104	HMI-GS-1903	BERGMANN 24 cm, 9 1/2" (300g)	

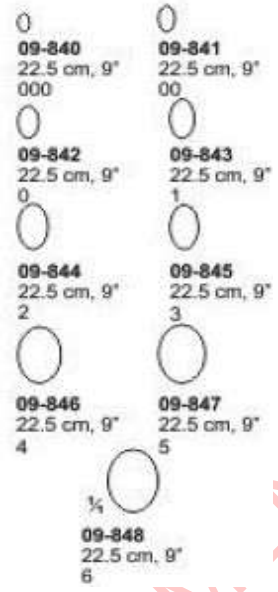
1921	104	HMI-GS-1904	GERZOG 18 cm, 7" (240g)	
1922	104	HMI-GS-1905	OMBREDANNE 24 cm, 9 1/2" 40 mm dia (550g)	
1923	104	HMI-GS-1906	COTTLE 19 cm, 7 1/2" (240g)	
1924	104	HMI-GS-1907	COLLIN 20 cm, 8" 30 mm dia 220 g	
1925	104	HMI-GS-1908	HEATH 16 cm Head 4.5 cm Dia. Weight 793 Gr.	
1926	105	HMI-GS-1909	BRUNS 17 cm, 7" 000	  09-830 17 cm, 7" 000  09-832 17 cm, 7" 0  09-831 17 cm, 7" 00  09-833 17 cm, 7" 1
1927	105	HMI-GS-1910	BRUNS 17 cm, 7" 00	
1928	105	HMI-GS-1911	BRUNS 17 cm, 7" 0	
1929	105	HMI-GS-1912	BRUNS 17 cm, 7" 1	
1930	105	HMI-GS-1913	BRUNS 17 cm, 7" 2	
1931	105	HMI-GS-1914	BRUNS 17 cm, 7" 3	

1932	105	HMI-GS-1915	BRUNS 17 cm, 7" 4
1933	105	HMI-GS-1916	BRUNS 17 cm, 7" 5
1934	105	HMI-GS-1917	BRUNS 17 cm, 7" 6
1935	105	HMI-GS-1918	HIBBS-SPRRATT / ANGLED 22.5 cm, 9" 000
1936	105	HMI-GS-1919	HIBBS-SPRRATT / ANGLED 22.5 cm, 9" 00
1937	105	HMI-GS-1920	HIBBS-SPRRATT / ANGLED 22.5 cm, 9" 0
1938	105	HMI-GS-1921	HIBBS-SPRRATT / ANGLED 22.5 cm, 9" 1
1939	105	HMI-GS-1922	HIBBS-SPRRATT / ANGLED 22.5 cm, 9" 2



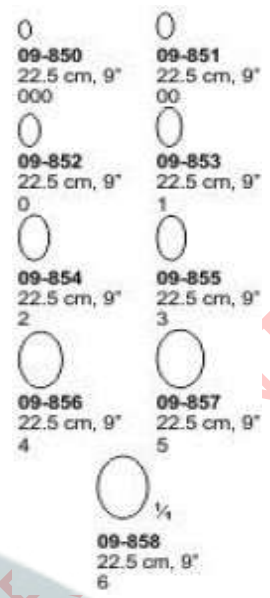
HEALER MEDICAL INSTRUMENTS

1940	105	HMI-GS-1923	HIBBS-SPRRATT / ANGLED 22.5 cm, 9" 3
1941	105	HMI-GS-1924	HIBBS-SPRRATT / ANGLED 22.5 cm, 9" 4
1942	105	HMI-GS-1925	HIBBS-SPRRATT / ANGLED 22.5 cm, 9" 5
1943	105	HMI-GS-1926	HIBBS-SPRRATT / ANGLED 22.5 cm, 9" 6
1944	105	HMI-GS-1927	HIBBS-SPRRATT / STRAIGHT 22.5 cm, 9" 000
1945	105	HMI-GS-1928	HIBBS-SPRRATT / STRAIGHT 22.5 cm, 9" 00
1946	105	HMI-GS-1929	HIBBS-SPRRATT / STRAIGHT 22.5 cm, 9" 0
1947	105	HMI-GS-1930	HIBBS-SPRRATT / STRAIGHT 22.5 cm, 9" 1



HEALER MEDICAL INSTRUMENTS












1948	105	HMI-GS-1931	HIBBS-SPRRATT / STRAIGHT 22.5 cm, 9" 2
1949	105	HMI-GS-1932	HIBBS-SPRRATT / STRAIGHT 22.5 cm, 9" 3
1950	105	HMI-GS-1933	HIBBS-SPRRATT / STRAIGHT 22.5 cm, 9" 4
1951	105	HMI-GS-1934	HIBBS-SPRRATT / STRAIGHT 22.5 cm, 9" 5
1952	105	HMI-GS-1935	HIBBS-SPRRATT / STRAIGHT 22.5 cm, 9" 6
1953	105	HMI-GS-1936	WILLIGER 13.25 cm, 5 1/2" Double Ended 00/0
1954	105	HMI-GS-1937	SPRATT / HOLLOW HANDLE 17 cm, 7" 00000
1955	105	HMI-GS-1938	SPRATT / HOLLOW HANDLE 17 cm, 7" 0000






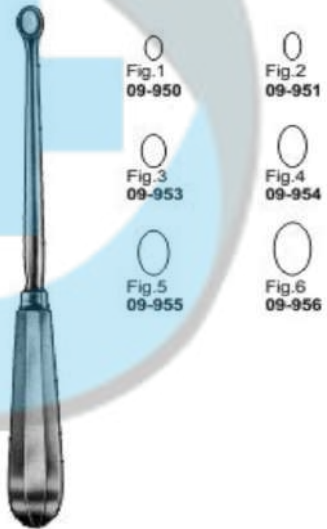
1956	105	HMI-GS-1939	SPRATT / HOLLOW HANDLE 17 cm, 7" 000
1957	105	HMI-GS-1940	SPRATT / HOLLOW HANDLE 17 cm, 7" 00
1958	105	HMI-GS-1941	SPRATT / HOLLOW HANDLE 17 cm, 7" 0
1959	105	HMI-GS-1942	SPRATT / HOLLOW HANDLE 17 cm, 7" 1
1960	105	HMI-GS-1943	SPRATT / HOLLOW HANDLE 17 cm, 7" 2
1961	105	HMI-GS-1944	SPRATT / HOLLOW HANDLE 17 cm, 7" 3
1962	105	HMI-GS-1945	SPRATT / HOLLOW HANDLE 17 cm, 7" 4
1963	105	HMI-GS-1946	SPRATT / HOLLOW HANDLE 17 cm, 7" 5



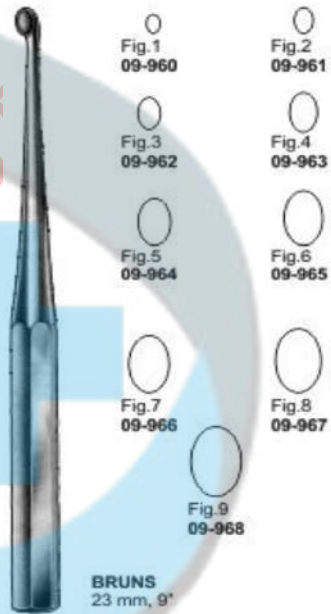
 09-870 17 cm, 7" 00000	 09-871 17 cm, 7" 0000	 09-872 17 cm, 7" 000
 09-873 17 cm, 7" 00	 09-874 17 cm, 7" 0	 09-875 17 cm, 7" 1
 09-876 17 cm, 7" 2	 09-877 17 cm, 7" 3	 09-878 17 cm, 7" 4
		 09-879 17 cm, 7" 5

1964	105	HMI-GS-1947	VOLKMANN 17 cm, 7" 0000		
1965	105	HMI-GS-1948	VOLKMANN 17 cm, 7" 000		
1966	105	HMI-GS-1949	VOLKMANN 17 cm, 7" 00		
1967	105	HMI-GS-1950	VOLKMANN 17 cm, 7" 0		
1968	105	HMI-GS-1951	VOLKMANN 17 cm, 7" 1		 09-890 17 cm, 7" 0000  09-891 17 cm, 7" 000  09-892 17 cm, 7" 00
1969	105	HMI-GS-1952	VOLKMANN 17 cm, 7" 2		 09-893 17 cm, 7" 0  09-894 17 cm, 7" 1  09-895 17 cm, 7" 2
1970	105	HMI-GS-1953	VOLKMANN 17 cm, 7" 3		 09-896 17 cm, 7" 3  09-897 17 cm, 7" 4  09-898 17 cm, 7" 5
1971	105	HMI-GS-1954	VOLKMANN 17 cm, 7" 4		 $\frac{3}{4}$ 09-899 17 cm, 7" 6






1972	105	HMI-GS-1955	VOLKMANN 17 cm, 7" 5	
1973	105	HMI-GS-1956	VOLKMANN 17 cm, 7" 6	
1974	105	HMI-GS-1957	VOLKMANN 13 cm, 5" Double Ended 6.2 mm & 6.7 mm	<p> 09-910 13 cm, 5" Double Ended 6.2 mm & 6.7 mm </p> <p> 09-911 16 cm, 6 1/2" Double Ended 7 mm & 9 mm </p> <p> 09-912 20 cm, 8" Double Ended 9.1 mm & 11.1 mm </p>
1975	105	HMI-GS-1958	VOLKMANN 16 cm, 6 1/2" Double Ended 7 mm & 9 mm	
1976	105	HMI-GS-1959	VOLKMANN 20 cm, 8" Double Ended 9.1 mm & 11.1 mm	
1977	106	HMI-GS-1960	BONE CURETTES 25 cm, 10" 3.6 mm	<p> 3.6 mm 09-920 </p> <p> 4.4 mm 09-921 </p> <p> 5.2 mm 09-922 </p> <p> 6.0 mm </p>
1978	106	HMI-GS-1961	BONE CURETTES 25 cm, 10" 4.4 mm	
1979	106	HMI-GS-1962	BONE CURETTES 25 cm, 10" 5.2 mm	

1980	106	HMI-GS-1963	BONE CURETTES 25 cm, 10" 6.0 mm		09-923	
1981	106	HMI-GS-1964	UFFENORDE Left 17.5 cm, 7"			
1982	106	HMI-GS-1965	UFFENORDE Right 17.5 cm, 7"			
1983	106	HMI-GS-1966	SIMON 24 cm, 9 1/2" Fig.1			
1984	106	HMI-GS-1967	SIMON 24 cm, 9 1/2" Fig.2		Fig.1 09-950	Fig.2 09-951
1985	106	HMI-GS-1968	SIMON 24 cm, 9 1/2" Fig.3		Fig.3 09-953	Fig.4 09-954
1986	106	HMI-GS-1969	SIMON 24 cm, 9 1/2" Fig.4		Fig.5 09-955	Fig.6 09-956
1987	106	HMI-GS-1970	SIMON 24 cm, 9 1/2" Fig.5			

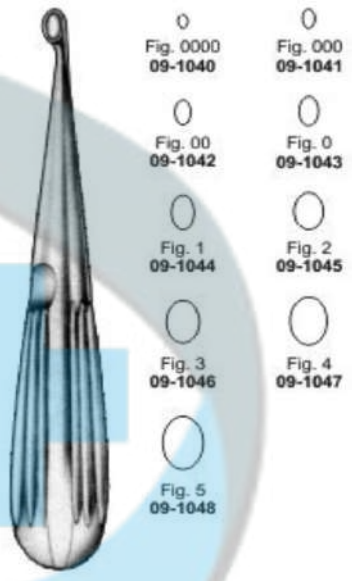
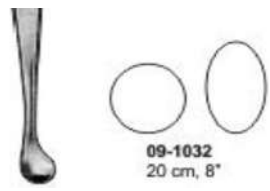
1988	106	HMI-GS-1971	SIMON 24 cm, 9 1/2" Fig.6
1989	106	HMI-GS-1972	BRUNS 23 mm, 9" Fig.1
1990	106	HMI-GS-1973	BRUNS 23 mm, 9" Fig.2
1991	106	HMI-GS-1974	BRUNS 23 mm, 9" Fig.3
1992	106	HMI-GS-1975	BRUNS 23 mm, 9" Fig.4
1993	106	HMI-GS-1976	BRUNS 23 mm, 9" Fig.5
1994	106	HMI-GS-1977	BRUNS 23 mm, 9" Fig.6
1995	106	HMI-GS-1978	BRUNS 23 mm, 9" Fig.7




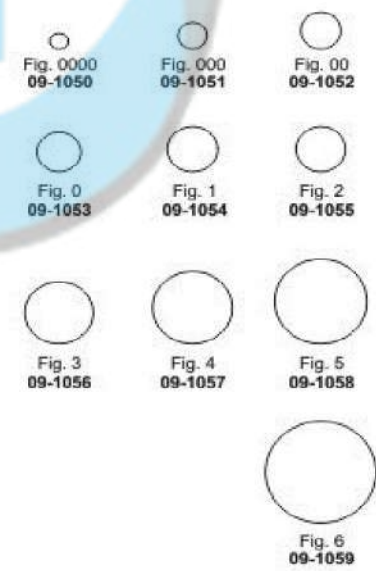
1996	106	HMI-GS-1979	BRUNS 23 mm, 9" Fig.8	
1997	106	HMI-GS-1980	BRUNS 23 mm, 9" Fig.9	
1998	106	HMI-GS-1981	WILLIGER 13.5 cm, 5 1/4"	
1999	106	HMI-GS-1982	WILLIGER 13.5 cm, 5 1/4"	
2000	106	HMI-GS-1983	WILLIGER 13.5 cm, 5 1/4"	
2001	106	HMI-GS-1984	MARTINI 13.5 cm, 5 1/4"	
2002	106	HMI-GS-1985	MARTINI 13.5 cm, 5 1/4"	
2003	106	HMI-GS-1986	MARTINI 13.5 cm, 5 1/4"	

2004	106	HMI-GS-1987	JANSEN 16 cm, 6 ¼"	
2005	106	HMI-GS-1988	JANSEN 15 cm, 6"	
2006	107	HMI-GS-1989	21 cm, 8 ¼"	
2007	107	HMI-GS-1990	VOLKMANN 13 cm, 5 ¼"	 <p>09-1020 13 cm, 5 ¼"</p> <p>09-1021 14 cm, 5 ½"</p> <p>09-1022 17 cm, 6 ¾"</p>
2008	107	HMI-GS-1991	VOLKMANN 14 cm, 5 ¼"	
2009	107	HMI-GS-1992	VOLKMANN 17 cm, 6 ¾"	
2010	107	HMI-GS-1993	VOLKMANN 13 cm, 5 ¼"	
2011	107	HMI-GS-1994	VOLKMANN 16 cm, 6 ¼"	 <p>09-1030 13 cm, 5 ¼"</p> <p>09-1031 16 cm, 6 ¼"</p>

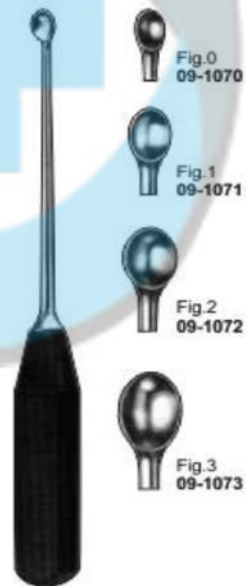
2012	107	HMI-GS-1995	VOLKMANN 20 cm, 8"
2013	107	HMI-GS-1996	SPRATT Fig. 0000
2014	107	HMI-GS-1997	SPRATT Fig. 000
2015	107	HMI-GS-1998	SPRATT Fig. 00
2016	107	HMI-GS-1999	SPRATT Fig. 0
2017	107	HMI-GS-2000	SPRATT Fig. 1
2018	107	HMI-GS-2001	SPRATT Fig. 2
2019	107	HMI-GS-2002	SPRATT Fig. 3








HEALER MEDICALS










2020	107	HMI-GS-2003	SPRATT Fig. 4	
2021	107	HMI-GS-2004	SPRATT Fig. 5	
2022	107	HMI-GS-2005	BRUNS Fig. 0000	 
2023	107	HMI-GS-2006	BRUNS Fig. 000	
2024	107	HMI-GS-2007	BRUNS Fig. 00	
2025	107	HMI-GS-2008	BRUNS Fig. 0	
2026	107	HMI-GS-2009	BRUNS Fig. 1	
2027	107	HMI-GS-2010	BRUNS Fig. 2	




2028	107	HMI-GS-2011	BRUNS Fig. 3
2029	107	HMI-GS-2012	BRUNS Fig. 4
2030	107	HMI-GS-2013	BRUNS Fig. 5
2031	107	HMI-GS-2014	BRUNS Fig. 6
2032	107	HMI-GS-2015	FIBER HANDLE 27 cm, 10 3/4" Fig.0
2033	107	HMI-GS-2016	FIBER HANDLE 27 cm, 10 3/4" Fig.2
2034	107	HMI-GS-2017	FIBER HANDLE 27 cm, 10 3/4" Fig.1
2035	107	HMI-GS-2018	FIBER HANDLE 27 cm, 10 3/4" Fig.3



HEALERMED INSTRUMENTS

2036	107	HMI-GS-2019	SCOVILLE 25 cm, 10" Straight	
2037	107	HMI-GS-2020	SCOVILLE 25 cm, 10" Down Angle	
2038	107	HMI-GS-2021	SCOVILLE 25 cm, 10" Up Angle	
2039	108	HMI-GS-2022	14 cm, 5 1/2"	
2040	108	HMI-GS-2023	14 cm, 5 1/2"	
2041	108	HMI-GS-2024	PERTHES 16 cm, 6 1/2"	
2042	108	HMI-GS-2025	PERTHES 22 cm, 8 3/4"	
2043	108	HMI-GS-2026	BONE HOOK 23 cm, 9" 3 cm Dia.	

2044	108	HMI-GS-2027	PUTTI 27 cm, 10 1/2"	
2045	108	HMI-GS-2028	PUTTI 30 cm, 12"	
2046	108	HMI-GS-2029	BONE TAMPS 15.4 cm, 6"	
2047	108	HMI-GS-2030	FOMAN RASP 21 cm, 8 1/2"	
2048	108	HMI-GS-2031	MILLER-COLBURN BONE FILE 18 cm, 7"	     <p>1/4 cross cut</p>
2049	108	HMI-GS-2032	MILLER-COLBURN BONE FILE 18 cm, 7" Fig. 1	
2050	108	HMI-GS-2033	MILLER-COLBURN BONE FILE 18 cm, 7" Fig. 2	
2051	108	HMI-GS-2034	MILLER-COLBURN BONE FILE 18 cm, 7" Fig. 3	

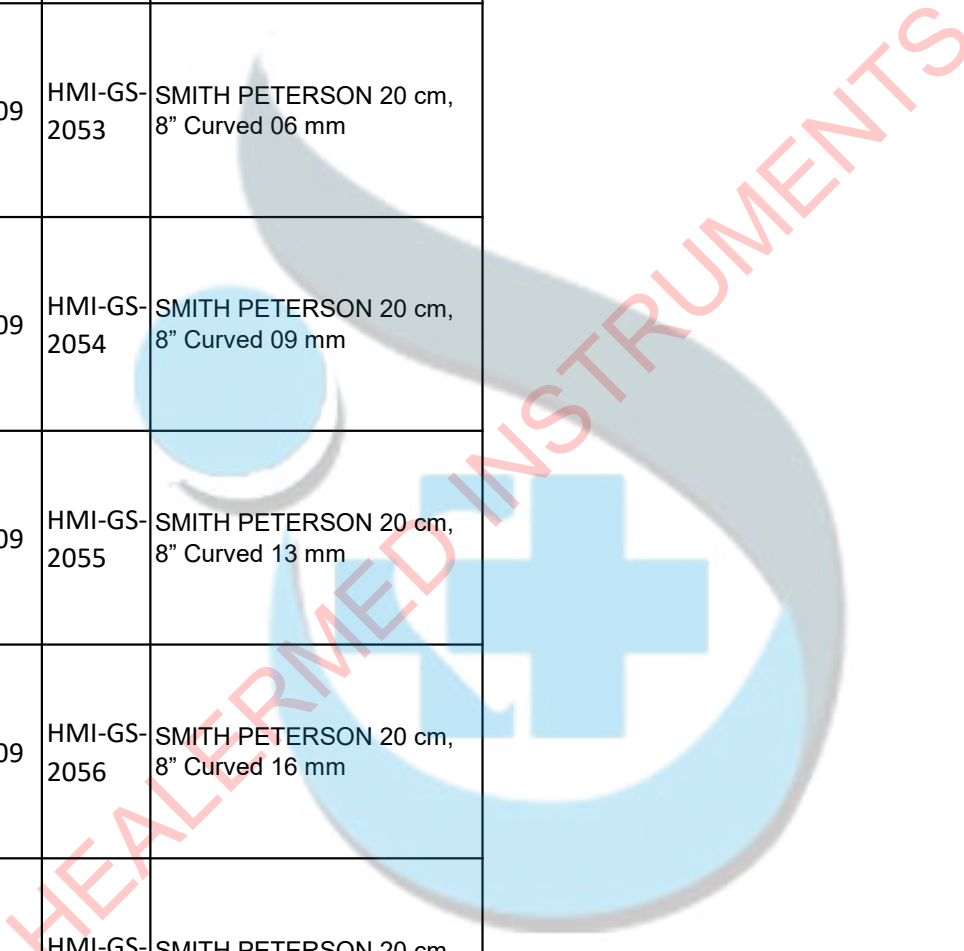
2052	108	HMI-GS-2035	MILLER-COLBURN BONE FILE 18 cm, 7" Fig. 4	
2053	108	HMI-GS-2036	MILLER ALVEOTOMY FILE 19 cm, 7 1/2"	
2054	108	HMI-GS-2037	MILLER ALVEOTOMY FILE 19 cm, 7 1/2"	
2055	109	HMI-GS-2038	SMITH PETERSON 20 cm, 8" Straight 09 mm	
2056	109	HMI-GS-2039	SMITH PETERSON 20 cm, 8" Straight 14 mm	
2057	109	HMI-GS-2040	SMITH PETERSON 20 cm, 8" Straight 19 mm	
2058	109	HMI-GS-2041	SMITH PETERSON 20 cm, 8" Straight 25 mm	
2059	109	HMI-GS-2042	SMITH PETERSON 20 cm, 8" Curved 09 mm	

2060	109	HMI-GS-2043	SMITH PETERSON 20 cm, 8" Curved 14 mm
2061	109	HMI-GS-2044	SMITH PETERSON 20 cm, 8" Curved 19 mm
2062	109	HMI-GS-2045	SMITH PETERSON 20 cm, 8" Curved 25 mm
2063	109	HMI-GS-2046	SMITH PETERSON 20 cm, 8" Straight 06 mm
2064	109	HMI-GS-2047	SMITH PETERSON 20 cm, 8" Straight 09 mm
2065	109	HMI-GS-2048	SMITH PETERSON 20 cm, 8" Straight 13 mm
2066	109	HMI-GS-2049	SMITH PETERSON 20 cm, 8" Straight 16 mm
2067	109	HMI-GS-2050	SMITH PETERSON 20 cm, 8" Straight 19 mm



HEALER MED INSTRUMENTS

2068	109	HMI-GS-2051	SMITH PETERSON 20 cm, 8" Straight 25 mm
2069	109	HMI-GS-2052	SMITH PETERSON 20 cm, 8" Straight 32 mm
2070	109	HMI-GS-2053	SMITH PETERSON 20 cm, 8" Curved 06 mm
2071	109	HMI-GS-2054	SMITH PETERSON 20 cm, 8" Curved 09 mm
2072	109	HMI-GS-2055	SMITH PETERSON 20 cm, 8" Curved 13 mm
2073	109	HMI-GS-2056	SMITH PETERSON 20 cm, 8" Curved 16 mm
2074	109	HMI-GS-2057	SMITH PETERSON 20 cm, 8" Curved 19 mm
2075	109	HMI-GS-2058	SMITH PETERSON 20 cm, 8" Curved 25 mm



2076	109	HMI-GS-2059	SMITH PETERSON 20 cm, 8" Curved 32 mm
2077	109	HMI-GS-2060	STILLE 20 cm, 8" Straight 10 mm
2078	109	HMI-GS-2061	STILLE 20 cm, 8" Straight 15 mm
2079	109	HMI-GS-2062	STILLE 20 cm, 8" Straight 20 mm
2080	109	HMI-GS-2063	STILLE 20 cm, 8" Straight 25 mm
2081	109	HMI-GS-2064	STILLE 20 cm, 8" Curved 10 mm
2082	109	HMI-GS-2065	STILLE 20 cm, 8" Curved 15 mm
2083	109	HMI-GS-2066	STILLE 20 cm, 8" Curved 20 mm



1/2

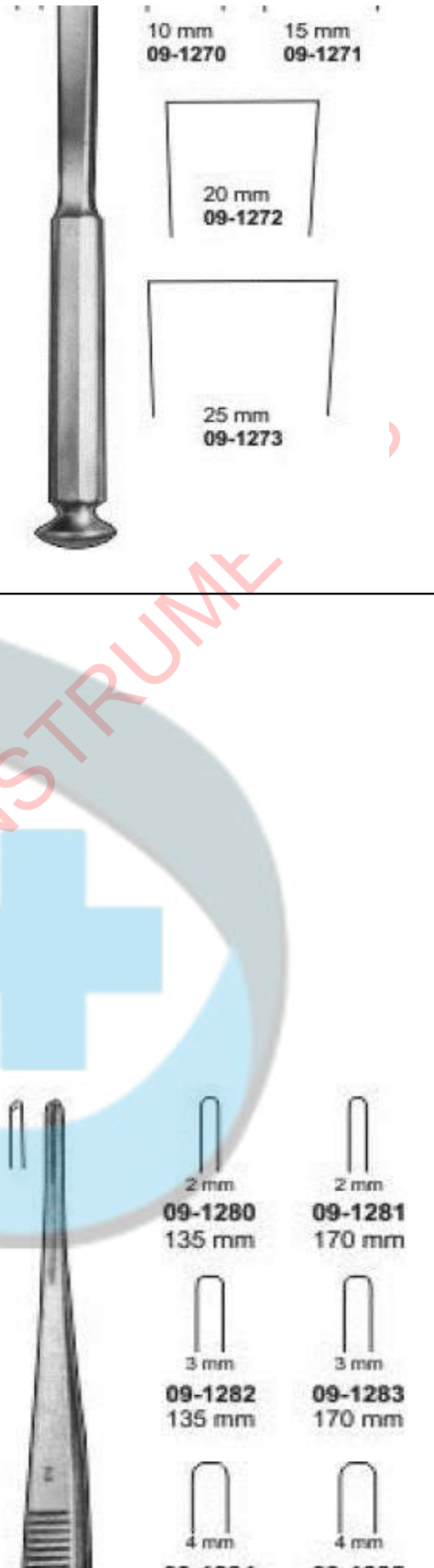
2084	109	HMI-GS-2067	STILLE 20 cm, 8" Curved 25 mm
2085	109	HMI-GS-2068	STILLE 20 cm, 8" CHISELS 10 mm
2086	109	HMI-GS-2069	STILLE 20 cm, 8" CHISELS 12 mm
2087	109	HMI-GS-2070	STILLE 20 cm, 8" CHISELS 15 mm
2088	109	HMI-GS-2071	STILLE 20 cm, 8" CHISELS 20 mm
2089	109	HMI-GS-2072	STILLE 20 cm, 8" CHISELS 25 mm
2090	109	HMI-GS-2073	STILLE 20 cm, 8" OSTEOTOME 10 mm
2091	109	HMI-GS-2074	STILLE 20 cm, 8" OSTEOTOME 12 mm






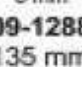
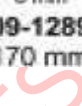





HEALER MEDICAL INSTRUMENTS

2092	109	HMI-GS-2075	STILLE 20 cm, 8" OSTEOTOME 15 mm	
2093	109	HMI-GS-2076	STILLE 20 cm, 8" OSTEOTOME 20 mm	
2094	109	HMI-GS-2077	STILLE 20 cm, 8" OSTEOTOME 25 mm	
2095	109	HMI-GS-2078	STILLE 20 cm, 8" 10 mm	
2096	109	HMI-GS-2079	STILLE 20 cm, 8" 15 mm	
2097	109	HMI-GS-2080	STILLE 20 cm, 8" 20 mm	
2098	109	HMI-GS-2081	STILLE 20 cm, 8" 25 mm	
2099	109	HMI-GS-2082	20 cm, 8" 10 mm	

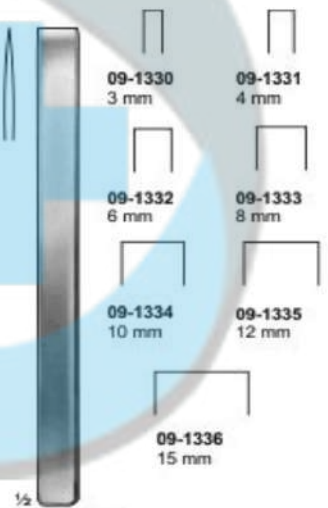
2100	109	HMI-GS-2083	20 cm, 8" 15 mm
2101	109	HMI-GS-2084	20 cm, 8" 20 mm
2102	109	HMI-GS-2085	20 cm, 8" 25 mm
2103	109	HMI-GS-2086	PARTSCH 135 mm
2104	109	HMI-GS-2087	PARTSCH 170 mm
2105	109	HMI-GS-2088	PARTSCH 135 mm
2106	109	HMI-GS-2089	PARTSCH 170 mm
2107	109	HMI-GS-2090	PARTSCH 135 mm



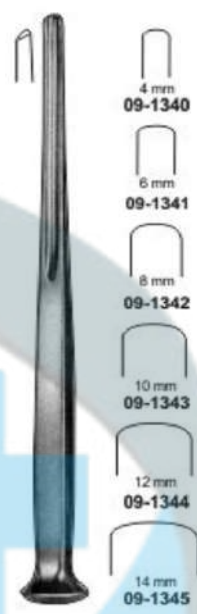
2108	109	HMI-GS-2091	PARTSCH 170 mm	 <p>PARTSCH</p>  <p>5 mm 09-1284 135 mm</p>  <p>5 mm 09-1285 170 mm</p>  <p>6 mm 09-1286 135 mm</p>  <p>6 mm 09-1287 170 mm</p>  <p>6 mm 09-1288 135 mm</p>  <p>6 mm 09-1289 170 mm</p>
2109	109	HMI-GS-2092	PARTSCH 135 mm	
2110	109	HMI-GS-2093	PARTSCH 170 mm	
2111	109	HMI-GS-2094	PARTSCH 135 mm	
2112	109	HMI-GS-2095	PARTSCH 170 mm	
2113	110	HMI-GS-2096	Straight 5 mm	
2114	110	HMI-GS-2097	Straight 10 mm	
2115	110	HMI-GS-2098	Straight 15 mm	

2116	110	HMI-GS-2099	Curved 5 mm	
2117	110	HMI-GS-2100	Curved 10 mm	
2118	110	HMI-GS-2101	Curved 15 mm	
2119	110	HMI-GS-2102	MINI-LAMBOTTE 12.5 cm, 5" 3 mm	
2120	110	HMI-GS-2103	MINI-LAMBOTTE 12.5 cm, 5" 4 mm	
2121	110	HMI-GS-2104	MINI-LAMBOTTE 12.5 cm, 5" 6 mm	
2122	110	HMI-GS-2105	MINI-LAMBOTTE 12.5 cm, 5" 8 mm	
2123	110	HMI-GS-2106	MINI-LAMBOTTE 12.5 cm, 5" 10 mm	

2124	110	HMI-GS-2107	MINI-LAMBOTTE 12.5 cm, 5" 12 mm
2125	110	HMI-GS-2108	MINI-LAMBOTTE 12.5 cm, 5" 15 mm
2126	110	HMI-GS-2109	MINI LAMBOTTE 17 cm, 6 3/4" 3 mm
2127	110	HMI-GS-2110	MINI LAMBOTTE 17 cm, 6 3/4" 4 mm
2128	110	HMI-GS-2111	MINI LAMBOTTE 17 cm, 6 3/4" 6 mm
2129	110	HMI-GS-2112	MINI LAMBOTTE 17 cm, 6 3/4" 8 mm
2130	110	HMI-GS-2113	MINI LAMBOTTE 17 cm, 6 3/4" 10 mm
2131	110	HMI-GS-2114	MINI LAMBOTTE 17 cm, 6 3/4" 12 mm

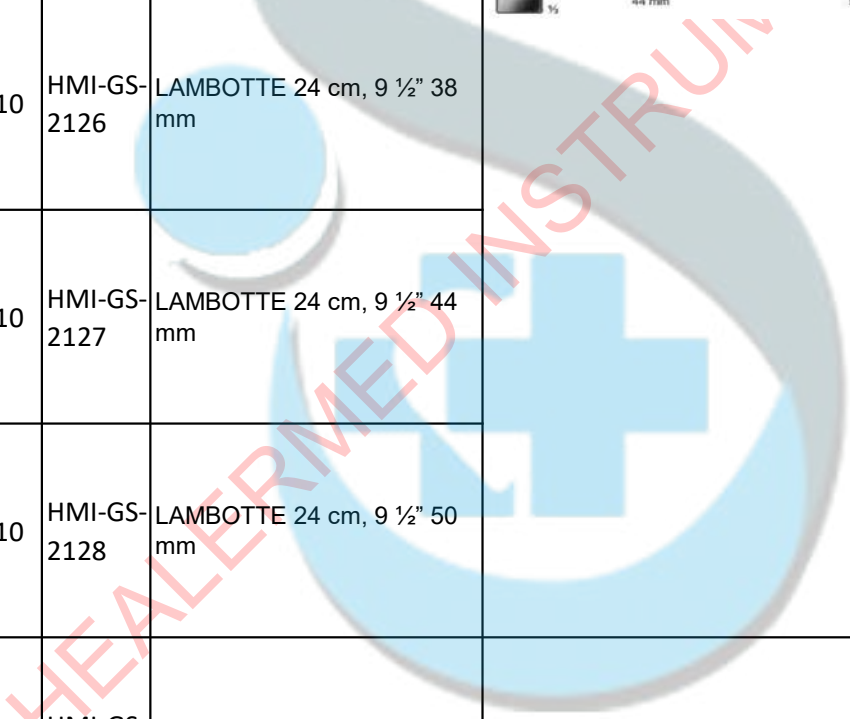
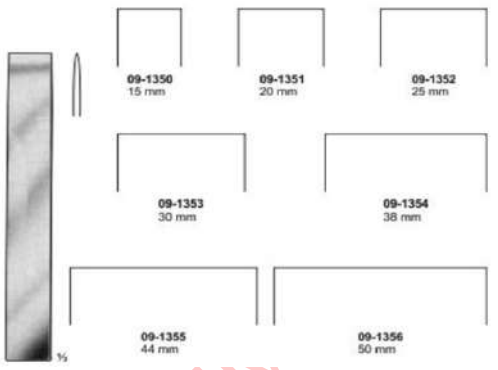


2132	110	HMI-GS-2115	MINI LAMBOTTE 17 cm, 6 3/4" 15 mm
2133	110	HMI-GS-2116	ALEXANDER 4 mm
2134	110	HMI-GS-2117	ALEXANDER 6 mm
2135	110	HMI-GS-2118	ALEXANDER 8 mm
2136	110	HMI-GS-2119	ALEXANDER 10 mm
2137	110	HMI-GS-2120	ALEXANDER 12 mm
2138	110	HMI-GS-2121	ALEXANDER 14 mm
2139	110	HMI-GS-2122	LAMBOTTE 24 cm, 9 1/2" 15 mm







HEALER MED INST
INTS



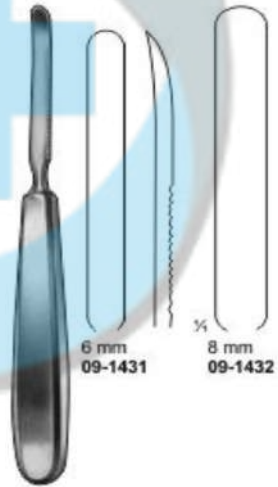

2140	110	HMI-GS-2123	LAMBOTTE 24 cm, 9 1/2" 20 mm
2141	110	HMI-GS-2124	LAMBOTTE 24 cm, 9 1/2" 25 mm
2142	110	HMI-GS-2125	LAMBOTTE 24 cm, 9 1/2" 30 mm
2143	110	HMI-GS-2126	LAMBOTTE 24 cm, 9 1/2" 38 mm
2144	110	HMI-GS-2127	LAMBOTTE 24 cm, 9 1/2" 44 mm
2145	110	HMI-GS-2128	LAMBOTTE 24 cm, 9 1/2" 50 mm
2146	110	HMI-GS-2129	LAMBOTTE 23 cm, 9" 15 mm
2147	110	HMI-GS-2130	LAMBOTTE 23 cm, 9" 20 mm



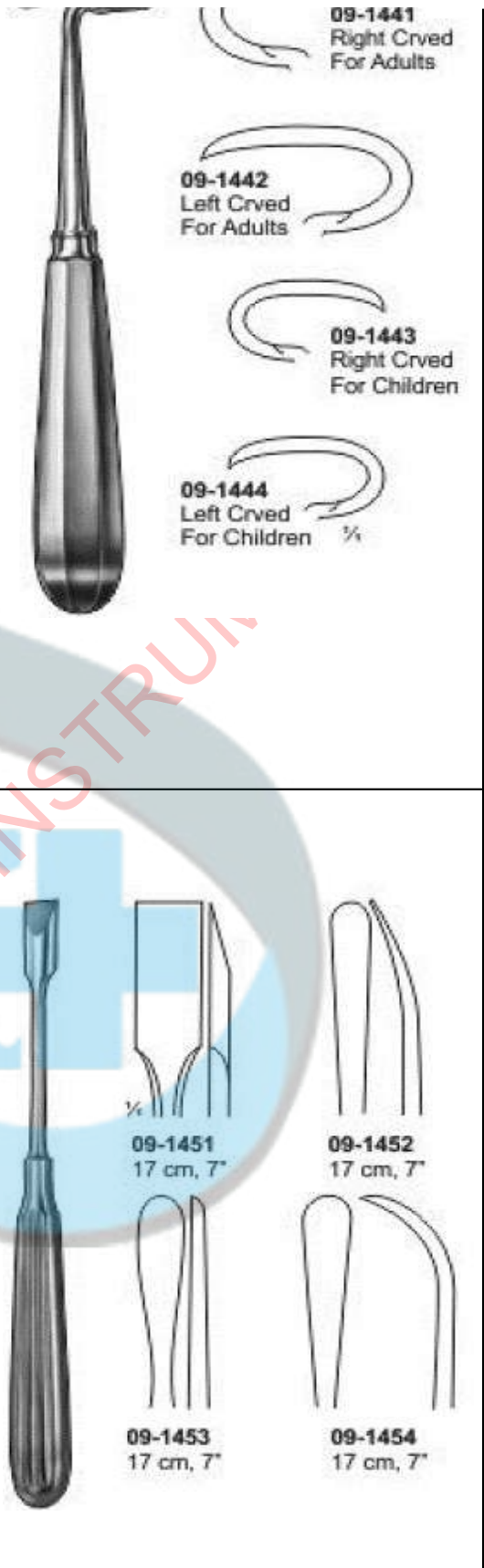
2148	110	HMI-GS-2131	LAMBOTTE 23 cm, 9" 25 mm
2149	110	HMI-GS-2132	LAMBOTTE 23 cm, 9" 30 mm
2150	110	HMI-GS-2133	LAMBOTTE 23 cm, 9" 38 mm
2151	110	HMI-GS-2134	LAMBOTTE 23 cm, 9" 44 mm
2152	110	HMI-GS-2135	LAMBOTTE 23 cm, 9" 50 mm
2153	111	HMI-GS-2136	PERIOSTEAL Elevator 18.2 cm, 7" Fiber/Phenolic Handle blade 6mm
2154	111	HMI-GS-2137	CHANDLER Bone Elevator 19 cm, 7 1/2" 13 mm
2155	111	HMI-GS-2138	CHANDLER Bone Elevator 20 cm, 8" 20 mm










2156	111	HMI-GS-2139	CHANDLER Bone Elevator 23 cm, 9" 25 mm	
2157	111	HMI-GS-2140	CHANDLER Bone Elevator 25 cm, 10" 31 mm	
2158	111	HMI-GS-2141	HOEN PERIOSTEAL Elevator 16.5 cm, 6 1/2"	
2159	111	HMI-GS-2142	KEY PERIOSTEAL Elevator 18 cm, 7 1/2"	
2160	111	HMI-GS-2143	KEY (Fig. A) 19 cm 7 1/2" 3 mm	
2161	111	HMI-GS-2144	KEY (Fig. A) 19 cm 7 1/2" 6 mm	
2162	111	HMI-GS-2145	KEY (Fig. A) 19 cm 7 1/2" 9 mm	
2163	111	HMI-GS-2146	KEY (Fig. A) 19 cm 7 1/2" 12 mm	




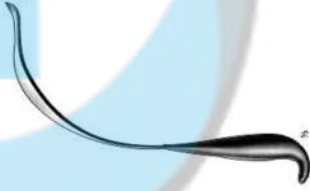


2164	111	HMI-GS-2147	KEY (Fig. A) 19 cm 7 1/2" 15 mm	
2165	111	HMI-GS-2148	KEY (Fig. A) 19 cm 7 1/2" 19 mm	
2166	111	HMI-GS-2149	KEY (Fig. A) 19 cm 7 1/2" 25 mm	
2167	111	HMI-GS-2150	COBB Elevators 23.4 cm, 9" Hex Handle	
2168	111	HMI-GS-2151	PERIOSTEAL ELEVATOR 17 cm, 7"	
2169	111	HMI-GS-2152	PERIOSTEAL ELEVATOR 17 cm, 7" 6 mm	
2170	111	HMI-GS-2153	PERIOSTEAL ELEVATOR 17 cm, 7" 8 mm	
2171	111	HMI-GS-2154	DOYEN RIB RASPATORY 17 cm, 7"	
				

2172	111	HMI-GS-2155	DOYEN RIB RASPATORY 17 cm, 7" Right Crved For Adults
2173	111	HMI-GS-2156	DOYEN RIB RASPATORY 17 cm, 7" Left Crved For Adults
2174	111	HMI-GS-2157	DOYEN RIB RASPATORY 17 cm, 7" Right Crved For Children
2175	111	HMI-GS-2158	DOYEN RIB RASPATORY 17 cm, 7" Left Crved For Children
2176	111	HMI-GS-2159	ADSON ELEVATOR 17 cm, 7"
2177	111	HMI-GS-2160	ADSON ELEVATOR 17 cm, 7"
2178	111	HMI-GS-2161	ADSON ELEVATOR 17 cm, 7"
2179	111	HMI-GS-2162	ADSON ELEVATOR 17 cm, 7"












2180	111	HMI-GS-2163	ADSON ELEVATOR 17 cm, 7"	
2181	112	HMI-GS-2164	20 cm, 8" Medium straight blade round edge, width 14 mm	
2182	112	HMI-GS-2165	20 cm, 8" Medium curved blade round edge, width 14 mm	
2183	112	HMI-GS-2166	18 cm, 7" Small curved blade round edge, width 6 mm	
2184	112	HMI-GS-2167	18 cm, 7" Small curved blade straight edge, width 6 mm	
2185	112	HMI-GS-2168	18 cm, 7" Extra small curved blade round edge, width 3 mm	
2186	112	HMI-GS-2169	20 cm, 8" large straight blade round edge, width 20 mm	
2187	112	HMI-GS-2170	Medium Blade Straight Edge, 14 mm Straight 18.5 cm, 7 1/2"	




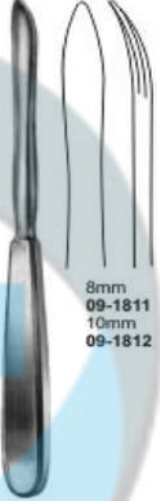
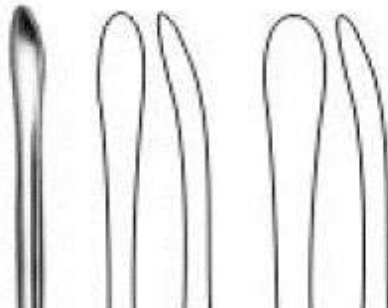
2188	112	HMI-GS-2171	Medium Blade Straight Edge, 14 mm Curved 18.5 cm, 7 1/2"	
2189	112	HMI-GS-2172	LANGENBECK 18 cm, 7"	
2190	112	HMI-GS-2173	LANGENBECK 19 cm, 7 1/2"	
2191	112	HMI-GS-2174	LAMBOTTE 21 cm, 8 1/2" 1.0 cm	
2192	112	HMI-GS-2175	LAMBOTTE 21 cm, 8 1/2" 1.5 cm	
2193	112	HMI-GS-2176	LAMBOTTE 21 cm, 8 1/2" 2.0 cm	
2194	112	HMI-GS-2177	FARABEUF 15 cm, 6"	
2195	112	HMI-GS-2178	FARABEUF 15 cm, 6"	




2196	112	HMI-GS-2179	16 cm, 6 1/2" 5 mm	
2197	112	HMI-GS-2180	16 cm, 6 1/2" 6 mm	
2198	112	HMI-GS-2181	16 cm, 6 1/2" 7 mm	
2199	113	HMI-GS-2182	AUFRANC 29 cm, 11 1/2"	
2200	113	HMI-GS-2183	AUFRANC 29 cm, 11 1/2"	
2201	113	HMI-GS-2184	AUFRANC 29 cm, 11 1/2"	
2202	113	HMI-GS-2185	BLOUNT KNEE RETRACTOR 17.5 cm, 7"	
2203	113	HMI-GS-2186	BENNETT 24 cm, 9 1/2" 43 mm, 60 mm, 65 mm,	


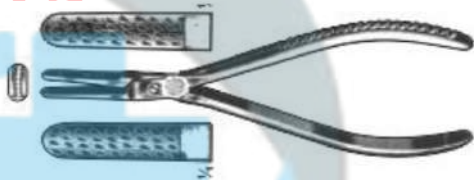
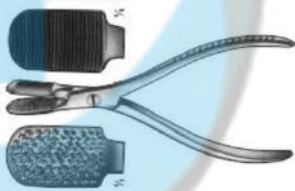


2204	113	HMI-GS-2187	PERIOSTEAL ELEVATOR 17.5 cm, 7" For Metacarpals Small 6 mm width	
2205	113	HMI-GS-2188	PERIOSTEAL ELEVATOR 17.5 cm, 7" For Metacarpals Medium 10 mm width	
2206	113	HMI-GS-2189	PERIOSTEAL ELEVATOR 17.5 cm, 7" Light Curve, Rounded End, 5 mm width	
2207	113	HMI-GS-2190	PERIOSTEAL ELEVATOR 17.5 cm, 7" Contra Angled Curve 4.5 mm width	
2208	113	HMI-GS-2191	18 cm, 7" Small, width 6 mm short, narrow tip	
2209	113	HMI-GS-2192	18 cm, 7" Small, width 8 mm short, narrow tip	
2210	113	HMI-GS-2193	12.5 cm, 5" For Small Fragments Board Shank	
2211	113	HMI-GS-2194	20 cm, 8" Width 8 mm short, narrow tip	



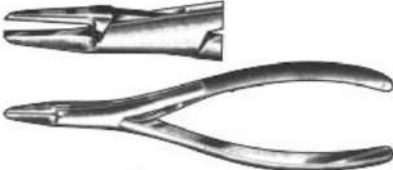





2212	113	HMI-GS-2195	20 cm, 8" Width 18 mm short, narrow tip	
2213	113	HMI-GS-2196	20 cm, 8" Width 18 mm long, narrow tip	
2214	114	HMI-GS-2197	HOHMANN 15 cm, 6"	
2215	114	HMI-GS-2198	HOHMANN 15.4 cm, 6" Short tip	
2216	114	HMI-GS-2199	18 cm, 7" Width 43 mm narrow tip	
2217	114	HMI-GS-2200	18 cm, 7" Width 70 mm narrow tip	
2218	114	HMI-GS-2201	18 cm, 7" Width 43 mm long shank, angled	
2219	114	HMI-GS-2202	16 cm, 6 1/2" width 22 mm wide tip	

2220	114	HMI-GS-2203	16 cm, 6 1/2" long wire tip for Hip Surgery, width 24 mm	
2221	114	HMI-GS-2204	LANGE-HOHMANN 27cm	
2222	114	HMI-GS-2205	LANGE-HOHMANN 29cm	
2223	114	HMI-GS-2206	LANGE-HOHMANN 27cm	
2224	114	HMI-GS-2207	LANGE-HOHMANN 29cm	
2225	114	HMI-GS-2208	LANGE-HOHMANN 24 cm, 9 1/2"	
2226	114	HMI-GS-2209	LANGE-HOHMANN 26 cm, 10 1/2"	
2227	114	HMI-GS-2210	LANGE-HOHMANN 29 cm, 11 1/2"	



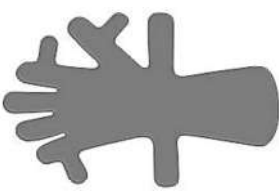

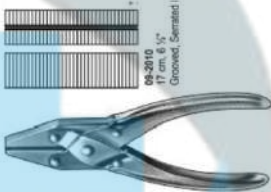
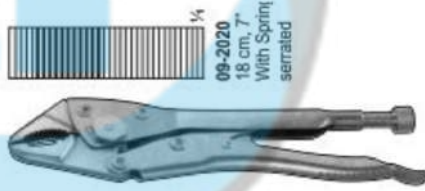


2228	114	HMI-GS-2211	RETRACTOR FOR KNEE 27 cm, 11" Blunt	
2229	114	HMI-GS-2212	ALEXANDER 20 cm, 8"	
2230	114	HMI-GS-2213	MATSON 22 cm, 9"	
2231	114	HMI-GS-2214	LANGENBECK ELEVATOR 19.5cm	 <p>8mm 09-1811 10mm 09-1812</p>
2232	114	HMI-GS-2215	LANGENBECK ELEVATOR 19.5cm 8mm	
2233	114	HMI-GS-2216	LANGENBECK ELEVATOR 19.5cm 10mm	
2234	114	HMI-GS-2217	MARTIN-LANGENBECK ELEVATOR 17cm	
2235	114	HMI-GS-2218	MARTIN-LANGENBECK ELEVATOR 17cm 5mm	

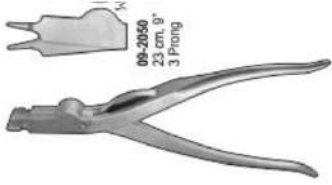
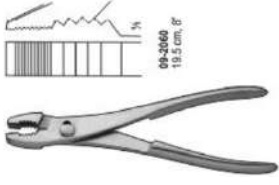


2236	114	HMI-GS-2219	MARTIN-LANGENBECK ELEVATOR 17cm 7mm	 <table border="0"> <tr> <td>5mm</td> <td>8mm</td> </tr> <tr> <td>09-1821</td> <td>09-1823</td> </tr> <tr> <td>7mm</td> <td>10mm</td> </tr> <tr> <td>09-1822</td> <td>09-1824</td> </tr> </table>	5mm	8mm	09-1821	09-1823	7mm	10mm	09-1822	09-1824
5mm	8mm											
09-1821	09-1823											
7mm	10mm											
09-1822	09-1824											
2237	114	HMI-GS-2220	MARTIN-LANGENBECK ELEVATOR 17cm 8mm									
2238	114	HMI-GS-2221	MARTIN-LANGENBECK ELEVATOR 17cm 10mm									
2239	114	HMI-GS-2222	Williger Elevator 17cm 7mm									
2240	114	HMI-GS-2223	Williger Elevator 17cm 5.5mm									
2241	115	HMI-GS-2224	Semb	 <p>09-1850 09-1851 09-1852 09-1853 09-1854 09-1855 09-1856</p>								
2242	115	HMI-GS-2225	Semb									
2243	115	HMI-GS-2226	Semb									



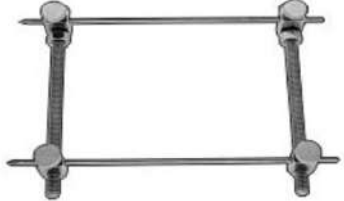
2244	115	HMI-GS-2227	Semb	
2245	115	HMI-GS-2228	Semb	
2246	115	HMI-GS-2229	Semb	
2247	115	HMI-GS-2230	Semb	
2248	115	HMI-GS-2231	NAIL EXTRACTING FORCEPS 14 cm, 5 1/2"	
2249	115	HMI-GS-2232	NAIL EXTRACTING FORCEPS 14.5 cm, 5 3/4"	
2250	115	HMI-GS-2233	Finger nail drill with 3 drill points	
2251	115	HMI-GS-2234	Frill points only	<p>Frill points only</p>  <p>09-1881 09-1882</p>



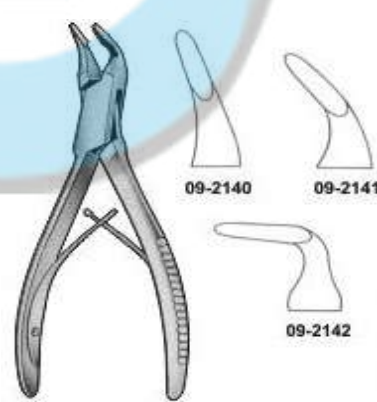
2252	115	HMI-GS-2235	Frill points only	
2253	115	HMI-GS-2236	Frill points only	 <p>09-1883</p>
2254	115	HMI-GS-2237	NAIL SPLITTING FORCEPS 13.5 cm, 5 1/4"	
2255	115	HMI-GS-2238	RING CUTTER 17 cm, 6 3/4"	
2256	115	HMI-GS-2239	RING CUTTER 17 cm, 6 3/4" Saw Blade Only for 09-1900	 <p>09-1901 Saw Blade Only for 09-1900</p>
2257	115	HMI-GS-2240	RING CUTTER 17 cm, 6 3/4"	
2258	115	HMI-GS-2241	RING CUTTER 17 cm, 6 3/4" Saw Blade Only for 09-1910	 <p>09-1911 Saw Blade Only for 09-1910</p>
2259	116	HMI-GS-2242	NEEDLE NOSE PLIERS 14 cm, 5 1/2" Cross serrated	 <p>09-1920 14 cm, 5 1/2" Cross serrated</p>


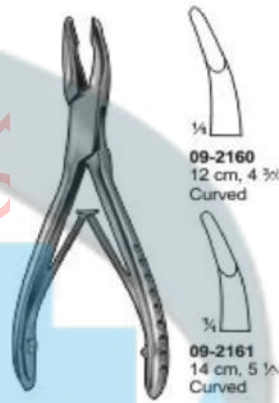
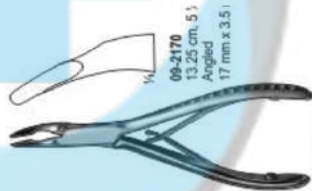


2260	116	HMI-GS-2243	NEEDLE NOSE PLIERS 19 cm, 7 1/2" Serrated	
2261	116	HMI-GS-2244	FLAT NOSE 18 cm, 7"	
2262	116	HMI-GS-2245	TENDON 15.25 cm, 6" 6 mm	
2263	116	HMI-GS-2246	BRAND 15 cm, 6"	
2264	116	HMI-GS-2247	BRAND 19 cm, 7 1/2"	
2265	116	HMI-GS-2248	BRAND 24 cm, 9 1/2"	
2266	116	HMI-GS-2249	BRAND 15 cm, 6"	
2267	116	HMI-GS-2250	BRAND 19 cm, 7 1/2"	


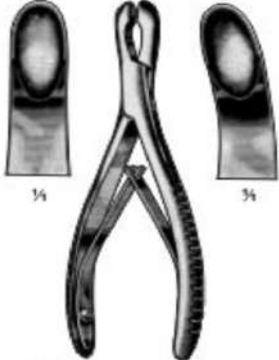

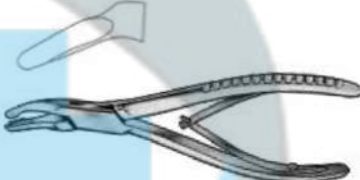
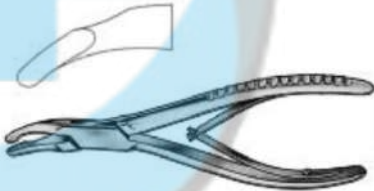

2268	116	HMI-GS-2251	BRAND 24 cm, 9 1/2"	
2269	116	HMI-GS-2252	CARROLL 13 cm, 5" Curved Shaft 2 mm x 6 mm	
2270	116	HMI-GS-2253	LEAD HAND Adult Size	
2271	116	HMI-GS-2254	FLAT NOSED PARALLEL PLIERS 18 cm, 7" with lateral wire cutter	
2272	117	HMI-GS-2255	FLAT NOSED PARALLEL PLIERS 17 cm, 6 1/2" Grooved, Serrated	
2273	117	HMI-GS-2256	LOCKING PLIERS 18 cm, 7" With Spring serrated	
2274	117	HMI-GS-2257	FLAT NOSED PLIER 18 cm, 7" parallell, with lateral wire cutter	
2275	117	HMI-GS-2258	LOUTE 21 cm, 8 1/2"	





2276	117	HMI-GS-2259	MODEL USA 23 cm, 9" 3 Prong	
2277	117	HMI-GS-2260	SLIP JOINT 19.5 cm, 8"	
2278	117	HMI-GS-2261	KIRSCHNER 40 x 140 mm	
2279	117	HMI-GS-2262	KIRSCHNER 60 x 220 mm	
2280	117	HMI-GS-2263	KIRSCHNER, AMERICAN TYPE Medium 130 mm Max. Jaw Opening	
2281	117	HMI-GS-2264	KIRSCHNER, AMERICAN TYPE Large 185 mm Max. Jaw Opening	
2282	117	HMI-GS-2265	KIRSCHNER, AMERICAN TYPE Extra Large 220 mm Max. Jaw Opening	
2283	117	HMI-GS-2266	KIRSCHNER 200 mm x 155 mm	

2284	117	HMI-GS-2267	KIRSCHNER 155 mm x 155 mm	
2285	117	HMI-GS-2268	KIRSCHNER 135 mm x 130 mm	
2286	117	HMI-GS-2269	KIRSCHNER 120 mm x 120 mm	
2287	117	HMI-GS-2270	KIRSCHNER 105 mm x 100 mm	
2288	117	HMI-GS-2271	KIRSCHNER 95 mm x 110 mm	
2289	117	HMI-GS-2272	KIRSCHNER 95 mm x 70 mm	
2290	117	HMI-GS-2273	SCREW NUT WRENCH 14 x 17 mm	
2291	117	HMI-GS-2274	CHARNLEY-MUELLER Compression Clamp	

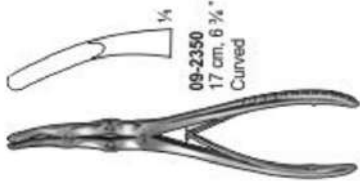
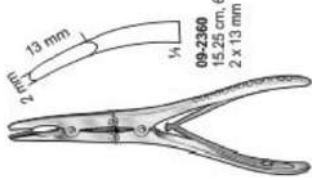
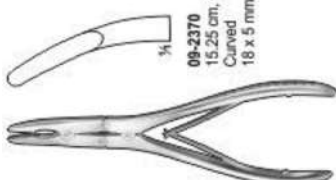
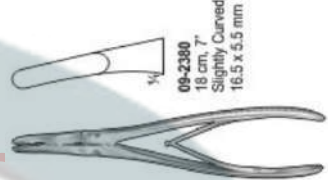
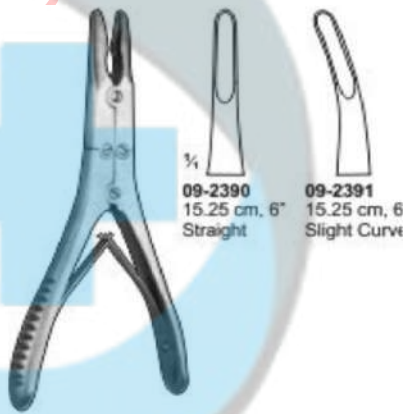

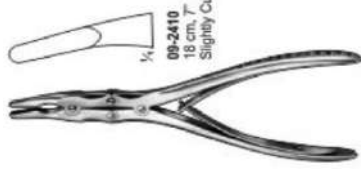
2292	117	HMI-GS-2275	Length 90 mm, Width 75 mm	
2293	117	HMI-GS-2276	Length 160 mm, Width 90 mm	
2294	117	HMI-GS-2277	Length 210 mm, Width 110 mm	
2295	117	HMI-GS-2278	Length 210 mm, Width 150 mm	
2296	118	HMI-GS-2279	HARTMANN 18.5 cm, 7 1/4"	
2297	118	HMI-GS-2280	BLUMENTHAL 15 cm, 6"	
2298	118	HMI-GS-2281	BLUMENTHAL 15 cm, 6"	
2299	118	HMI-GS-2282	BLUMENTHAL 15 cm, 6"	

2300	118	HMI-GS-2283	LUER 15 cm, 6"	
2301	118	HMI-GS-2284	LUER 15 cm, 6"	
2302	118	HMI-GS-2285	LUER 15 cm, 6"	
2303	118	HMI-GS-2286	FRIEDMAN & MINI-FRIEDMAN 12 cm, 4 3/4" Curved	
2304	118	HMI-GS-2287	FRIEDMAN & MINI-FRIEDMAN 14 cm, 5 1/2" Curved	
2305	118	HMI-GS-2288	UNIVERSAL 13.25 cm, 5 1/2" Angled 17 mm x 3.5 mm	 <p>09-2170 13.25 cm, 5 1/2" Angled 17 mm x 3.5</p>
2306	118	HMI-GS-2289	BACON 20 cm, 8"	
2307	118	HMI-GS-2290	STELLBRINK SYNOVCTOMY RONGEUR 17.5 cm, 7"	 <p>09-2190 17.5 cm, 7" 1/2</p> <p>09-2191 17 cm, 6 3/4" 1/2</p>

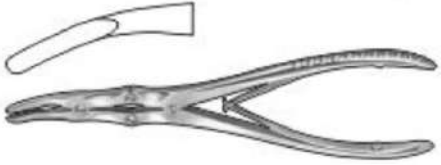

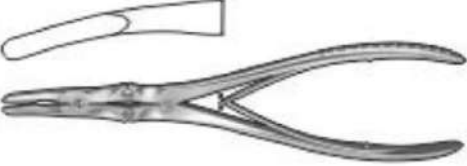



2308	118	HMI-GS-2291	STELLBRINK SYNOVCTOMY RONGEUR 17 cm, 6 3/4"	
2309	118	HMI-GS-2292	LUER 17 cm, 6 3/4" straight	
2310	118	HMI-GS-2293	LUER 17 cm, 6 3/4" curved	
2311	118	HMI-GS-2294	LUER 15.5 cm, 6" Curved- Small 9 mm x 3.5 mm	
2312	118	HMI-GS-2295	CLEVELAND 14 cm, 5 1/2"	
2313	118	HMI-GS-2296	CLEVELAND 17 cm, 6 3/4"	
2314	118	HMI-GS-2297	MEAD 16.5 cm, 6 1/2"	
2315	118	HMI-GS-2298	MEAD 16.5 cm, 6 1/2"	

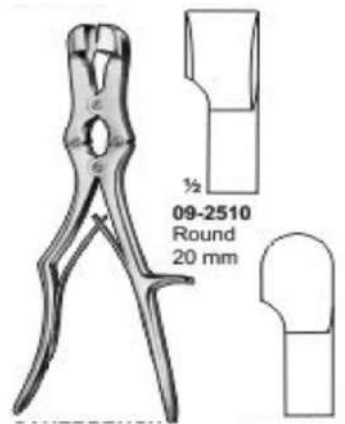
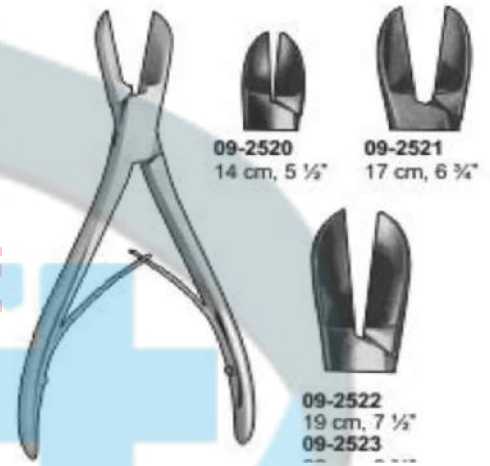

2316	119	HMI-GS-2299	LEMPERT 19 cm, 7 1/2" straight	
2317	119	HMI-GS-2300	LEMPERT 19 cm, 7 1/2" curved	
2318	119	HMI-GS-2301	LEMPERT 16 cm, 6 1/2" Curved	 <p> <small>1/4</small> 09-2260 16 cm, 6 1/2" Curved 09-2261 19 cm, 7 1/2" Straight 12 mm x 3 mm 09-2262 19 cm, 7 1/2" Curved </p>
2319	119	HMI-GS-2302	LEMPERT 19 cm, 7 1/2" Straight 12 mm x 3 mm	
2320	119	HMI-GS-2303	LEMPERT 19 cm, 7 1/2" Curved	
2321	119	HMI-GS-2304	ADSON 20 cm, 8" Straight 15 mm x 7.5 mm	
2322	119	HMI-GS-2305	BANE 18 cm, 7" Slightly Curved,	 <p> <small>1/4</small> 09-2260 18 cm, 7" Slightly Curved </p>
2323	119	HMI-GS-2306	HAKANSSON 15.5 cm, 6"	

















2324	119	HMI-GS-2307	STILLE-RUSKIN 23 cm, 9"	
2325	119	HMI-GS-2308	LEKSELL-STILLE 24 cm, 9 1/2"	
2326	119	HMI-GS-2309	LEKSELL-STILLE 24 cm, 9 1/2"	
2327	119	HMI-GS-2310	STILLE-LUER 22 cm, 8 3/4"	
2328	119	HMI-GS-2311	STILLE-LUER 22 cm, 8 3/4"	
2329	119	HMI-GS-2312	ECHLIN / STILLE-LUER 23 cm, 9"	
2330	119	HMI-GS-2313	ECHLIN / STILLE-LUER 23 cm, 9"	
2331	119	HMI-GS-2314	BEYER RONGEUR 18 cm, 7" curved	



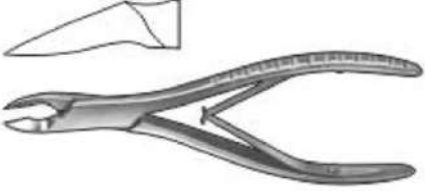





2332	119	HMI-GS-2315	MAYFIELD 17 cm, 6 3/4" Curved	 <p>09-2350 17 cm, 6 3/4" Curved</p>
2333	119	HMI-GS-2316	KLEINERT-KUTZ 15.25 cm, 6" 2 x 13 mm	 <p>13 mm 1/4 09-2360 15.25 cm, 6" 2 x 13 mm</p>
2334	119	HMI-GS-2317	RUSKIN-MINI 15.25 cm, 6" Curved 18 x 5 mm	 <p>1/4 09-2370 15.25 cm, 6" Curved 18 x 5 mm</p>
2335	119	HMI-GS-2318	RUSKIN 18 cm, 7" Slightly Curved 16.5 x 5.5 mm	 <p>1/4 09-2380 18 cm, 7" Slightly Curved 16.5 x 5.5 mm</p>
2336	120	HMI-GS-2319	BÖHLER 15.25 cm, 6" Straight	 <p>1/4 09-2390 15.25 cm, 6" Straight</p> <p>09-2391 15.25 cm, 6" Slight Curve</p>
2337	120	HMI-GS-2320	BÖHLER 15.25 cm, 6" Slight Curve	
2338	120	HMI-GS-2321	BEYER 18 cm, 7" Curved	 <p>3/16 09-2400 18 cm, 7" Curved</p>
2339	120	HMI-GS-2322	ZAUFAL-JANSEN 18 cm, 7" Slightly Curved	 <p>1/4 09-2410 18 cm, 7" Slightly Curved</p>



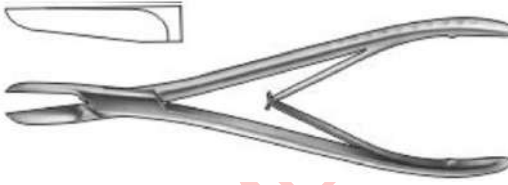
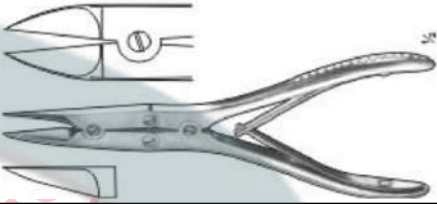

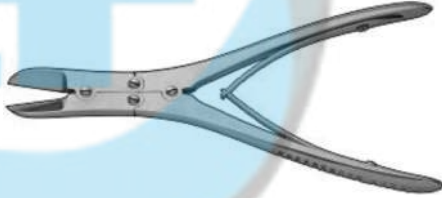

2340	120	HMI-GS-2323	SEMB 22.5 cm, 9"	
2341	120	HMI-GS-2324	STILLE 23 cm, 9" Duckbill 17 mm x 6 mm	
2342	120	HMI-GS-2325	ECHLIN 23 cm, 9" 2 mm	
2343	120	HMI-GS-2326	ECHLIN 23 cm, 9" 3 mm	
2344	120	HMI-GS-2327	ECHLIN 23 cm, 9" 4 mm	
2345	120	HMI-GS-2328	LEKSELL 22 cm, 8 3/4" 3 mm	
2346	120	HMI-GS-2329	LEKSELL 22 cm, 8 3/4" 5 mm	
2347	120	HMI-GS-2330	LEKSELL 22 cm, 8 3/4" 8 mm	

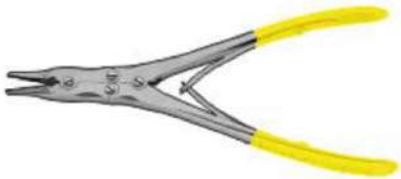

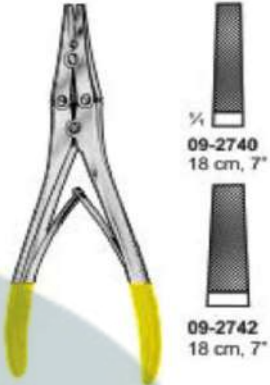


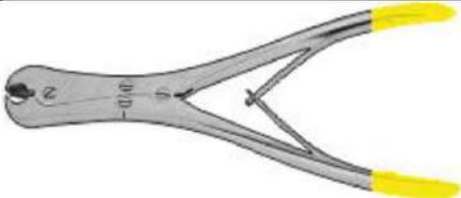
2348	120	HMI-GS-2331	MAYFIELD 17 cm, 6 3/4"	
2349	120	HMI-GS-2332	RUSKIN RONGEUR curved	
2350	120	HMI-GS-2333	MARQUARDT 20 cm, 8"	
2351	120	HMI-GS-2334	STILLE-LUER Rongeur Forceps 23 cm, 9" straight	 <p>STILLE-LUER Rongeur Forceps</p>  <p>09-2490 23 cm, 9"</p>  <p>09-2491 27 cm, 10 1/2" straight</p> <p>09-2492 23 cm, 9"</p> <p>09-2493 27 cm, 10 1/2" curved</p>
2352	120	HMI-GS-2335	STILLE-LUER Rongeur Forceps 27 cm, 10 1/2" straight	
2353	120	HMI-GS-2336	STILLE-LUER Rongeur Forceps 23 cm, 9" curved	
2354	120	HMI-GS-2337	STILLE-LUER Rongeur Forceps 27 cm, 10 1/2" curved	
2355	120	HMI-GS-2338	STILLE RONGEUR FORCEPS 23 cm, 9" Double-Action jaws 3mm wide Jaws angled to side	





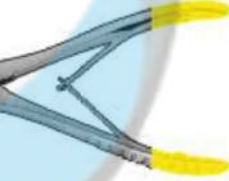
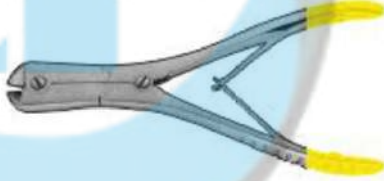


2356	120	HMI-GS-2339	SAUERBRUCH 31 cm, 12 ¼" Round 20 mm	 <p>09-2510 Round 20 mm</p>
2357	120	HMI-GS-2340	SAUERBRUCH 31 cm, 12 ¼" Straight 20 mm	
2358	121	HMI-GS-2341	LISTON BONE Cutting Forceps 14 cm, 5 ½"	 <p>09-2520 14 cm, 5 ½"</p> <p>09-2521 17 cm, 6 ¾"</p> <p>09-2522 19 cm, 7 ½"</p> <p>09-2523</p>
2359	121	HMI-GS-2342	LISTON BONE Cutting Forceps 17 cm, 6 ¾"	
2360	121	HMI-GS-2343	LISTON BONE Cutting Forceps 19 cm, 7 ½"	
2361	121	HMI-GS-2344	LISTON BONE Cutting Forceps 22 cm, 8 ¾"	
2362	121	HMI-GS-2345	LISTON 14 cm, 5 ½"	
2363	121	HMI-GS-2346	LISTON 17 cm, 6 ¾"	






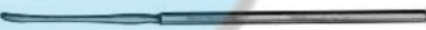


2364	121	HMI-GS-2347	LISTON 19 cm, 7 1/2"	 09-2530 14 cm, 5 1/2"  09-2531 17 cm, 6 3/4"  
2365	121	HMI-GS-2348	LISTON 22 cm, 8 3/4"	 09-2532 19 cm, 7 1/2"  09-2533 22 cm, 8 3/4"
2366	121	HMI-GS-2349	MARKWALDER 20 cm, 8"	
2367	121	HMI-GS-2350	LITTAUER / LISTON 15 cm, 6" Straight,	 09-2550 15 cm, 6" Straight, 
2368	121	HMI-GS-2351	CLEVELAND-GARDNER 16 cm, 6 1/2"	 09-2560 16 cm, 6 1/2" 
2369	121	HMI-GS-2352	WALTON-LISTON 15 cm, 6" Straight	 WALTON-LISTON  09-2570 15 cm, 6" Straight
2370	121	HMI-GS-2353	WALTON-LISTON 15 cm, 6" Angled	 09-2571 15 cm, 6" Angled
2371	121	HMI-GS-2354	RUSKIN-LISTON 19 cm, 7 1/2" Straight	 09-2580 19 cm, 7 1/2" Straight no. 2481 








2372	121	HMI-GS-2355	RUSKIN-LISTON 19 cm, 7 1/2" Curved	 <p>19 cm, 7 1/2" Curved</p>
2373	121	HMI-GS-2356	STILLE-LISTO 27 cm, 10 1/2" Straight	
2374	121	HMI-GS-2357	CLEVELAND 17 cm, 6 3/4"	
2375	121	HMI-GS-2358	CLEVELAND 15 cm, 6"	
2376	121	HMI-GS-2359	LISTON 23 cm, 9" Angled	
2377	121	HMI-GS-2360	LISTON 27 cm, 10 1/2" Angled	 <p>09-2620 23 cm, 9" Angled</p> <p>09-2621 27 cm, 10 1/2" Angled</p>
2378	122	HMI-GS-2361	LISTON-STILLE 26 cm, 10 1/4"	
2379	122	HMI-GS-2362	Mc INDOE 17.5 cm, 7"	




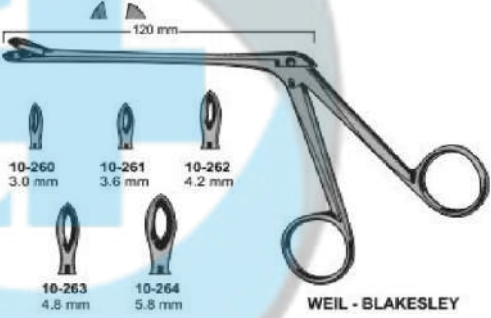
2380	122	HMI-GS-2363	HORSLEY Bone Cutting Forceps 25 cm, 10"	
2381	122	HMI-GS-2364	LISTON-KEY (HORSLEY) 26.5 cm, 10 1/2" Angled, 28 mm	
2382	122	HMI-GS-2365	COTTLE-KAZANJIAN 19 cm, 7 1/2"	
2383	122	HMI-GS-2366	15 cm, 5 3/4"	
2384	122	HMI-GS-2367	SEMB 24 cm, 9 1/2"	
2385	122	HMI-GS-2368	RUSKIN BONE SPLITTING FORCEPS 20 cm, 8", Double-Action	
2386	123	HMI-GS-2369	EXTRACTION PLIERS 18 cm, 7"	
2387	123	HMI-GS-2370	EXTRACTION PLIERS 18 cm, 7"	

2388	123	HMI-GS-2371	EXTRACTION PLIERS 20 cm, 8"	
2389	123	HMI-GS-2372	EXTRACTION PLIERS 20 cm, 8"	
2390	123	HMI-GS-2373	WIRE CUTTERS 18 cm, 7"	 <p>¼ 09-2740 18 cm, 7"</p> <p>09-2742 18 cm, 7"</p>
2391	123	HMI-GS-2374	WIRE CUTTERS 18 cm, 7"	
2392	123	HMI-GS-2375	WIRE CUTTERS 18 cm, 7"	
2393	123	HMI-GS-2376	WIRE CUTTERS 18 cm, 7"	
2394	123	HMI-GS-2377	WIRE CUTTERS 21 cm, 8 ¼"	
2395	123	HMI-GS-2378	WIRE CUTTERS 18 cm, 7"	

2396	123	HMI-GS-2379	UNIVERSAL SCISSORS 10 cm, 4"	
2397	123	HMI-GS-2380	UNIVERSAL SCISSORS 12 cm, 5"	
2398	123	HMI-GS-2381	WIRE CUTTER 18 cm, 7"	
2399	123	HMI-GS-2382	WIRE CUTTERS 18 cm, 7"	
2400	123	HMI-GS-2383	WIRE CUTTERS 21 cm, 8 1/2"	
2401	123	HMI-GS-2384	WIRE CUTTERS 14 cm, 5 1/2"	
2402	123	HMI-GS-2385	WIRE CUTTERS 22 cm, 8 3/4"	
2403	123	HMI-GS-2386	WIRE CUTTERS 46 cm, 18"	

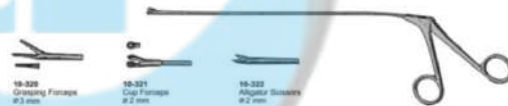
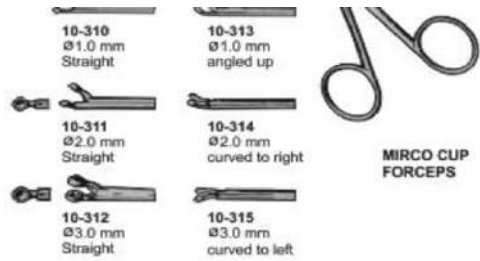
2404	123	HMI-GS-2387	WIRE CUTTERS 56 cm, 22"	
2405	123	HMI-GS-2388	24 cm, 9 1/2" 2.0 mm, 1.6 mm	
2406	NEURO SURGERY			
2407				
2408	124	HMI-GS-2389	SCOVILLE 30 cm, 12" Nerve Hook and Dissector	
2409	124	HMI-GS-2390	SCOVILLE 30 cm, 12" Nerve Hook and Dissector	
2410	124	HMI-GS-2391	SCOVILLE 30 cm, 12" Sympathectomy Hook and Dissector	
2411	124	HMI-GS-2392	NERVE SEPARATOR & SPATULA Davis 4 mm, 19 cm, 7 1/2"	
2412	124	HMI-GS-2393	NERVE SEPARATOR & SPATULA Sachs 3 mm, 20 cm, 8"	
2413	124	HMI-GS-2394	NERVE SEPARATOR & SPATULA Sachs 6 mm, 20 cm, 8"	


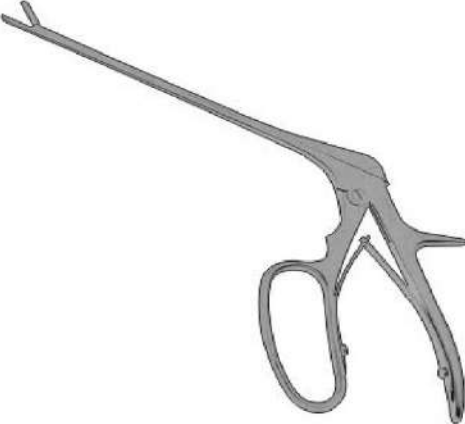






2414	124	HMI-GS-2395	GRAHAM 16.5cm	
2415	124	HMI-GS-2396	SACHS 16.5cm	
2416	124	HMI-GS-2397	FRAZIER 12.5 cm, 5"	
2417	124	HMI-GS-2398	GILLIES 19 cm, 7 1/2" Small	
2418	124	HMI-GS-2399	GILLIES 19 cm, 7 1/2" large	
2419	124	HMI-GS-2400	Straight 13 cm, 5"	
2420	124	HMI-GS-2401	LAHEY CLINIC 13 cm, 5"	
2421	124	HMI-GS-2402	SACHS 18.5 cm, 7 1/4"	





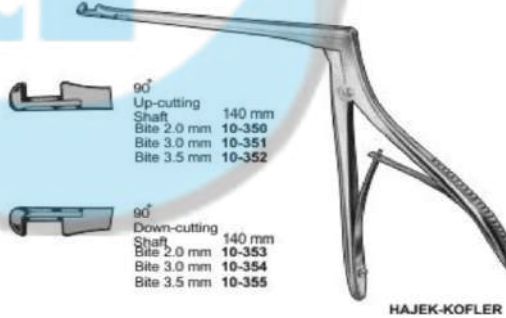
2422	124	HMI-GS-2403	16 cm, 6 ½"	
2423	124	HMI-GS-2404	TOENNIS 15 cm, 6"	
2424	124	HMI-GS-2405	DURA TWIST HOOK 14 cm, 5 ½"	
2425	125	HMI-GS-2406	WEIL - BLAKESLEY 3.0 mm	
2426	125	HMI-GS-2407	WEIL - BLAKESLEY 3.6 mm	
2427	125	HMI-GS-2408	WEIL - BLAKESLEY 4.2 mm	
2428	125	HMI-GS-2409	WEIL - BLAKESLEY 4.8 mm	
2429	125	HMI-GS-2410	WEIL - BLAKESLEY 5.8 mm	

2430	125	HMI-GS-2411	WILDE INTERVERTEBRAL DISC RONGEUR 12.5 cm, 5" shaft fenestrated jaws straight small 4 x 9 mm bite	<p>10-270 small 4 x 9 mm bite</p> <p>10-271 Medium 5 x 10 mm bite</p> <p>10-272 large 6 x 11 mm bite</p> <p>WILDE INTERVERTEBRAL DISC RONGEUR 12.5 cm, 5" shaft fenestrated jaws straight</p>
2431	125	HMI-GS-2412	WILDE INTERVERTEBRAL DISC RONGEUR 12.5 cm, 5" shaft fenestrated jaws straight Medium 5 x 10 mm bite	
2432	125	HMI-GS-2413	WILDE INTERVERTEBRAL DISC RONGEUR 12.5 cm, 5" shaft fenestrated jaws straight large 6 x 11 mm bite	
2433	125	HMI-GS-2414	DECKER INTERVERTEBRAL DISC RONGEUR 15 cm, 6" shaft 2 x 6 mm bite straight	<p>DECKER INTERVERTEBRAL DISC RONGEUR 10-288 15 cm, 6" shaft 2 x 6 mm bite straight</p>
2434	125	HMI-GS-2415	MICRO GRASPING FORCEPS serrated, straight	<p>Working length 14 mm</p> <p>MICRO GRASPING FORCEPS 10-290 serrated, straight</p>
2435	125	HMI-GS-2416	MICRO ALLIGATOR SCISSORS straight	
2436	125	HMI-GS-2417	MIRCO CUP FORCEPS Ø1.0 mm Straight	
2437	125	HMI-GS-2418	MIRCO CUP FORCEPS Ø2.0 mm Straight	

2438	125	HMI-GS-2419	MIRCO CUP FORCEPS Ø3.0 mm Straight
2439	125	HMI-GS-2420	MIRCO CUP FORCEPS Ø1.0 mm angled up
2440	125	HMI-GS-2421	MIRCO CUP FORCEPS Ø2.0 mm curved to right
2441	125	HMI-GS-2422	MIRCO CUP FORCEPS Ø3.0 mm curved to left
2442	126	HMI-GS-2423	MICRO ALLIGATOR FORCEPS with tubular shaft 18 cm, 7" Grasping Forceps Ø3 mm
2443	126	HMI-GS-2424	MICRO ALLIGATOR FORCEPS with tubular shaft 18 cm, 7" Cup Forceps Ø2 mm
2444	126	HMI-GS-2425	MICRO ALLIGATOR FORCEPS with tubular shaft 18 cm, 7" Alligator Scissors Ø2 mm
2445	126	HMI-GS-2426	FERRIS - SMITH Straight Shaft Bite 2 x 10 mm 180 mm



2446	126	HMI-GS-2427	FERRIS - SMITH Straight Shaft Bite 3 x 10 mm 180 mm	
2447	126	HMI-GS-2428	FERRIS - SMITH Straight Shaft Bite 4 x 10 mm 180 mm	
2448	126	HMI-GS-2429	FERRIS - SMITH Angled - up Shaft Bite 2 x 10 mm 180 mm	
2449	126	HMI-GS-2430	FERRIS - SMITH Angled - up Shaft Bite 3 x 10 mm 180 mm	
2450	126	HMI-GS-2431	FERRIS - SMITH Angled - up Shaft Bite 4 x 10 mm 180 mm	
2451	126	HMI-GS-2432	FERRIS - SMITH Angled - down Shaft Bite 2 x 10 mm 180 mm	
2452	126	HMI-GS-2433	FERRIS - SMITH Angled - down Shaft Bite 3 x 10 mm 180 mm	
2453	126	HMI-GS-2434	FERRIS - SMITH Angled - down Shaft Bite 4 x 10 mm 180 mm	

2454	126	HMI-GS-2435	PITUITARY RONGEUR OldBerg Shaft Bite Ø4 mm 180 mm	 
2455	126	HMI-GS-2436	PITUITARY RONGEUR OldBerg Shaft Bite Ø5 mm 180 mm	
2456	126	HMI-GS-2437	PITUITARY RONGEUR OldBerg Shaft Bite Ø6 mm 180 mm	
2457	127	HMI-GS-2438	HAJEK-KOFLER 90° Up-cutting Shaft Bite 2.0 mm 140 mm	
2458	127	HMI-GS-2439	HAJEK-KOFLER 90° Up-cutting Shaft Bite 3.0 mm 140 mm	  <p> 90° Up-cutting Shaft 140 mm Bite 2.0 mm 10-350 Bite 3.0 mm 10-351 Bite 3.5 mm 10-352 </p> <p> 90° Down-cutting Shaft 140 mm Bite 2.0 mm 10-353 Bite 3.0 mm 10-354 Bite 3.5 mm 10-355 </p> <p>HAJEK-KOFLER</p>
2459	127	HMI-GS-2440	HAJEK-KOFLER 90° Up-cutting Shaft Bite 3.5 mm 140 mm	
2460	127	HMI-GS-2441	HAJEK-KOFLER 90° Down-cutting Shaft Bite 2.0 mm 140 mm	
2461	127	HMI-GS-2442	HAJEK-KOFLER 90° Down-cutting Shaft Bite 3.0 mm 140 mm	

2462	127	HMI-GS-2443	HAJEK-KOFLER 90° Down-cutting Shaft Bite 3.5 mm 140 mm	
2463	127	HMI-GS-2444	CITELLI 1.0 mm	
2464	127	HMI-GS-2445	CITELLI 2.5 mm	
2465	127	HMI-GS-2446	CITELLI 4.0 mm	
2466	127	HMI-GS-2447	HAJEK-KOFLER 160 mm, 6 1/4" 3.5 mm	
2467	127	HMI-GS-2448	SPURLING-LOVE 28cm	
2468	127	HMI-GS-2449	SPURLING-LOVE 28cm	
2469	127	HMI-GS-2450	OLDBERG 25cm	

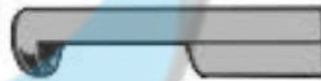
2470	127	HMI-GS-2451	COLCLOUGH 27cm UP CUTTING	
2471	127	HMI-GS-2452	COLCLOUGH 27cm DOWN CUTTING	
2472	128	HMI-GS-2453	LOVE-KERRISON LAMINECTOMY PUNCH Forward 90° Regular Footplate 2 mm bite forward 150 mm	
2473	128	HMI-GS-2454	LOVE-KERRISON LAMINECTOMY PUNCH Forward 90° Regular Footplate 2 mm bite forward 200 mm	
2474	128	HMI-GS-2455	LOVE-KERRISON LAMINECTOMY PUNCH Forward 90° Regular Footplate 3 mm bite forward 150 mm	
2475	128	HMI-GS-2456	LOVE-KERRISON LAMINECTOMY PUNCH Forward 90° Regular Footplate 3 mm bite forward 200 mm	
2476	128	HMI-GS-2457	LOVE-KERRISON LAMINECTOMY PUNCH Forward 90° Regular Footplate 4 mm bite forward 150 mm	
2477	128	HMI-GS-2458	LOVE-KERRISON LAMINECTOMY PUNCH Forward 90° Regular Footplate 4 mm bite forward 200 mm	

2478	128	HMI-GS-2459	LOVE-KERRISON LAMINECTOMY PUNCH Forward 90° Regular Footplate 5 mm bite forward 150 mm
2479	128	HMI-GS-2460	LOVE-KERRISON LAMINECTOMY PUNCH Forward 90° Regular Footplate 5 mm bite forward 200 mm
2480	128	HMI-GS-2461	LOVE-KERRISON LAMINECTOMY PUNCH Forward 90° Regular Footplate 6 mm bite forward 150 mm
2481	128	HMI-GS-2462	LOVE-KERRISON LAMINECTOMY PUNCH Forward 90° Regular Footplate 6 mm bite forward 200 mm
2482	128	HMI-GS-2463	LOVE-KERRISON LAMINECTOMY PUNCH Up 40° Regular footplate 2 mm bite up 150 mm
2483	128	HMI-GS-2464	LOVE-KERRISON LAMINECTOMY PUNCH Up 40° Regular footplate 2 mm bite up 200 mm
2484	128	HMI-GS-2465	LOVE-KERRISON LAMINECTOMY PUNCH Up 40° Regular footplate 3 mm bite up 150 mm
2485	128	HMI-GS-2466	LOVE-KERRISON LAMINECTOMY PUNCH Up 40° Regular footplate 3 mm bite up 200 mm



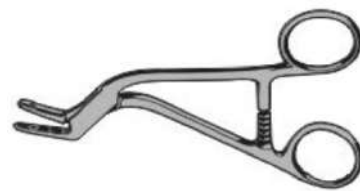


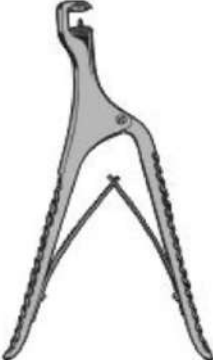


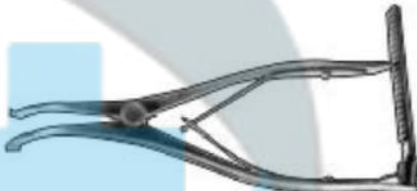
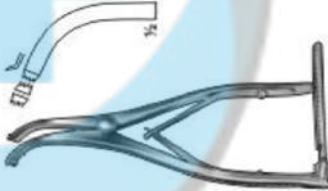

HEALTHCARE INSTRUMENTS






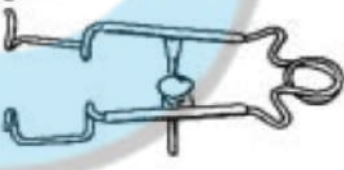


2486	128	HMI-GS-2467	LOVE-KERRISON LAMINECTOMY PUNCH Up 40° Regular footplate 4 mm bite up 150 mm
2487	128	HMI-GS-2468	LOVE-KERRISON LAMINECTOMY PUNCH Up 40° Regular footplate 4 mm bite up 200 mm
2488	128	HMI-GS-2469	LOVE-KERRISON LAMINECTOMY PUNCH Up 40° Regular footplate 5 mm bite up 150 mm
2489	128	HMI-GS-2470	LOVE-KERRISON LAMINECTOMY PUNCH Up 40° Regular footplate 5 mm bite up 200 mm
2490	128	HMI-GS-2471	LOVE-KERRISON LAMINECTOMY PUNCH Up 40° Regular footplate 6 mm bite up 200 mm
2491	128	HMI-GS-2472	LOVE-KERRISON LAMINECTOMY PUNCH Down 90° Regular footplate 3 mm bite down 150 mm
2492	128	HMI-GS-2473	LOVE-KERRISON LAMINECTOMY PUNCH Down 90° Regular footplate 3 mm bite down 200 mm
2493	128	HMI-GS-2474	LOVE-KERRISON LAMINECTOMY PUNCH Down 90° Regular footplate 4 mm bite down 150 mm










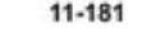



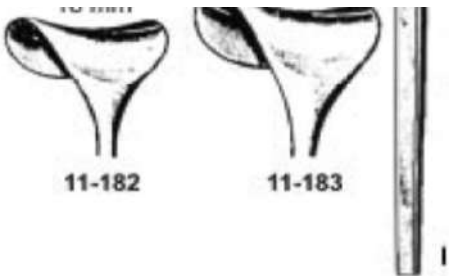

HEALTHMEDICALINSTRUMENTS

2494	128	HMI-GS-2475	LOVE-KERRISON LAMINECTOMY PUNCH Down 90° Regular footplate 4 mm bite down 200 mm	
2495	128	HMI-GS-2476	LOVE-KERRISON LAMINECTOMY PUNCH Down 90° Regular footplate 5 mm bite down 150 mm	
2496	128	HMI-GS-2477	LOVE-KERRISON LAMINECTOMY PUNCH Down 90° Regular footplate 5 mm bite down 200 mm	
2497	129	HMI-GS-2478	MCKENZIE 15cm	
2498	129	HMI-GS-2479	MCKENZIE 19cm	
2499	129	HMI-GS-2480	RANEY 16 cm, 6 1/2"	
2500	129	HMI-GS-2481	RANEY 1.7cm, 3/4"	
2501	129	HMI-GS-2482	ADSON 15 cm, 6" Drill Guide and Dura Protector	






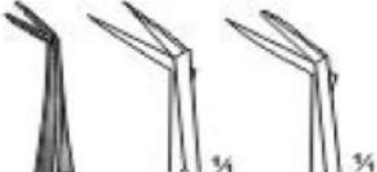
2502	129	HMI-GS-2483	CONE 20 cm 8" Skull Punch	
2503	129	HMI-GS-2484	CONE 23 cm 9" Skull Punch	
2504	129	HMI-GS-2485	DAHLGREN 20 cm, 8" Complete with 2 Blades	
2505	129	HMI-GS-2486	DE VILBISS Skull cutting forceps 21cm, 8 1/4"	
2506	129	HMI-GS-2487	INGE 16 cm, 6 1/2" Small pattern	
2507	129	HMI-GS-2488	INGE 17 cm, 6 3/4"	
2508	129	HMI-GS-2489	INGE 26 cm, 10 1/4" Jaw width 5 mm large pattern	
2509	129	HMI-GS-2490	INGE 26 cm, 10 1/4" Jaw width 10 mm large pattern	




2510	129	HMI-GS-2491	CLOWARD 13 cm, 5"	
2511	129	HMI-GS-2492	LUMBAR LAMINA SPREADER arm length: 87.5 mm, spread: 37.5 mm	
2512	129	HMI-GS-2493	CLOWARD 16 cm, 6 1/2"	
2513	129	HMI-GS-2494	14 cm, 5 1/2"	
2514 2515	OPHTHAMALOGY INSTRUMENTS			
2516	130	HMI-GS-2495	BOWMAN 7 cm	
2517	130	HMI-GS-2496	CRITCHETT 6 cm	
2518	130	HMI-GS-2497	SMITH 5 cm	
2519	130	HMI-GS-2498	CLARKE 8 cm	









2520	130	HMI-GS-2499	GRAEFE 6 cm	
2521	130	HMI-GS-2500	GRAEFE 9 cm	
2522	130	HMI-GS-2501	ARRUGA 7 cm L	
2523	130	HMI-GS-2502	ARRUGA 9 cm R	
2524	130	HMI-GS-2503	MELLINGER 7 cm	
2525	130	HMI-GS-2504	MUELLER 7 cm	
2526	130	HMI-GS-2505	DESMARRES 12 cm	  12 mm  14 mm  16 mm  18 mm  14 mm  18 mm
2527	130	HMI-GS-2506	DESMARRES 14 cm	









2528	130	HMI-GS-2507	DESMARRES 16 cm	
2529	130	HMI-GS-2508	DESMARRES 18 cm	
2530	130	HMI-GS-2509	KNIVES CATARACT Fig 1	
2531	130	HMI-GS-2510	KNIVES CATARACT Fig 2	
2532	130	HMI-GS-2511	KNIVES CATARACT Fig 3	
2533	130	HMI-GS-2512	KNIVES CATARACT Fig 4	
2534	130	HMI-GS-2513	KNIVES CATARACT Fig 5	
2535	130	HMI-GS-2514	KNIVES CATARACT Fig 6	







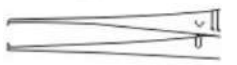
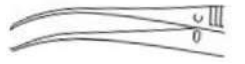
2536	130	HMI-GS-2515	BEER Fig 1	
2537	130	HMI-GS-2516	BEER Fig 2	
2538	130	HMI-GS-2517	JAEGER	
2539	130	HMI-GS-2518	JAEGER	
2540	130	HMI-GS-2519	JAEGER	
2541	130	HMI-GS-2520	JAEGER	
2542	130	HMI-GS-2521	JAEGER	
2543	130	HMI-GS-2522	JAEGER	

2544	130	HMI-GS-2523	JAEGER	
2545	130	HMI-GS-2524	JAEGER	
2546	131	HMI-GS-2525	SNELLEN R	
2547	131	HMI-GS-2526	SNELLEN L	
2548	131	HMI-GS-2527	DESMARRES 10cm	
2549	131	HMI-GS-2528	DESMARRES 10cm	
2550	131	HMI-GS-2529	KNAPP 11cm	
2551	131	HMI-GS-2530	WECKER 11cm S/S	

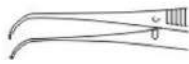




2552	131	HMI-GS-2531	WECKER 11cm S/B	
2553	131	HMI-GS-2532	WECKER 11cm B/B	
2554	131	HMI-GS-2533	AYER 9cm	
2555	131	HMI-GS-2534	LAMPBERT 9cm	
2556	131	HMI-GS-2535	DESMARRES 9cm	
2557	131	HMI-GS-2536	DESMARRES 9cm	
2558	131	HMI-GS-2537	DESMARRES 9cm	
2559	131	HMI-GS-2538	DASTOOR 1:2 10cm	



2560	131	HMI-GS-2539	STRABISMUS 1:2 11cm	
2561	131	HMI-GS-2540	STRABISMUS 2:3 11cm	
2562	131	HMI-GS-2541	CASTROVIJO 9cm	
2563	131	HMI-GS-2542	WORTH 10cm	
2564	131	HMI-GS-2543	WORTH 10cm	
2565	131	HMI-GS-2544	HESS 1:2 9cm	
2566	131	HMI-GS-2545	HESS 1:2 9cm	
2567	131	HMI-GS-2546	FISCHER 1:2 7cm	

2568	131	HMI-GS-2547	FISCHER 1:2	
2569	132	HMI-GS-2548	ARRUGA 9.5cm	
2570	132	HMI-GS-2549	ELSCHING 10cm	
2571	132	HMI-GS-2550	HESS 6.5cm	
2572	132	HMI-GS-2551	6cm	
2573	132	HMI-GS-2552	FUCHS 7cm	
2574	132	HMI-GS-2553	HESS 6cm	
2575	132	HMI-GS-2554	ELSCHING 11cm	

2576	132	HMI-GS-2555	GRAEFE 11cm	
2577	132	HMI-GS-2556	GRAEFE 11cm	
2578	132	HMI-GS-2557	SCHMIDT-RIMPLEX 11cm	
2579	132	HMI-GS-2558	GRAEFE Serated 10cm	
2580	132	HMI-GS-2559	GRAEFE Serated 10cm	
2581	132	HMI-GS-2560	GRAEFE Serated 10cm	
2582	132	HMI-GS-2561	GRAEFE Serated 10cm	
2583	132	HMI-GS-2562	GRAEFE Serated 10cm	



2584	132	HMI-GS-2563	GRAEFE Serated 10cm	
2585	132	HMI-GS-2564	GRAEFE 7cm STR	
2586	132	HMI-GS-2565	GRAEFE 7cm CUR	
2587	132	HMI-GS-2566	GRAEFE 7cm 1:2 STR	
2588	132	HMI-GS-2567	GRAEFE 7cm 1:2 CUR	
2589	132	HMI-GS-2568	BISHOP-HRRMAN SERRATED 8.5cm	
2590	132	HMI-GS-2569	BISHOP-HRRMAN 1:2 8.5cm	
2591	132	HMI-GS-2570	HESS 1:2	

2592	132	HMI-GS-2571	HESS 1:3	
2593	ENT			
2594				
2595	133	HMI-GS-2572	BOUCHERON Set of 4	
2596	133	HMI-GS-2573	BOUCHERON Set of 4 3.5 mm	
2597	133	HMI-GS-2574	BOUCHERON Set of 4 4.5 mm	
2598	133	HMI-GS-2575	BOUCHERON Set of 4 5.5 mm	
2599	133	HMI-GS-2576	BOUCHERON Set of 4 6.5 mm	
2600	133	HMI-GS-2577	PLOITZER Set of 4	
2601	133	HMI-GS-2578	PLOITZER Set of 4 2 mm	
2602	133	HMI-GS-2579	PLOITZER Set of 4 3 mm	
2603	133	HMI-GS-2580	PLOITZER Set of 4 4 mm	
2604	133	HMI-GS-2581	PLOITZER Set of 4 5 mm	
2605	133	HMI-GS-2582	HARTMANN for children Set of 3	
2606	133	HMI-GS-2583	HARTMANN for children Set of 3 2 mm	
2607	133	HMI-GS-2584	HARTMANN for children Set of 33.5 mm	

2608	133	HMI-GS-2585	HARTMANN for children Set of 3 5 mm
2609	133	HMI-GS-2586	HARTMANN Set of 4, For Adults 4.0 mm
2610	133	HMI-GS-2587	HARTMANN Set of 4, For Adults 5.0 mm
2611	133	HMI-GS-2588	HARTMANN Set of 4, For Adults 6.0 mm
2612	133	HMI-GS-2589	HARTMANN Set of 4, For Adults 7.5 mm
2613	133	HMI-GS-2590	ZOLLNER Set of 6, Alu Black 5.3 x 6.5 mm
2614	133	HMI-GS-2591	ZOLLNER Set of 6, Alu Black 7.5 x 8.5 mm
2615	133	HMI-GS-2592	ZOLLNER Set of 6, Alu Black 6.5 x 7.5 mm
2616	133	HMI-GS-2593	ZOLLNER Set of 6, Alu Black 8.5 x 9.5 mm
2617	133	HMI-GS-2594	ZOLLNER Set of 6, Alu Black 9.5 x 10.5 mm
2618	133	HMI-GS-2595	ZOLLNER Set of 6, Alu Black 10.5 x 11.5 mm
2619	133	HMI-GS-2596	GRUBER AURAL SPECULA Black finish, diam, 38 mm Set of 4
2620	133	HMI-GS-2597	GRUBER AURAL SPECULA Black finish, diam, 38 mm Set of 4 3 mm
2621	133	HMI-GS-2598	GRUBER AURAL SPECULA Black finish, diam, 38 mm Set of 4 4 mm






2622	133	HMI-GS-2599	GRUBER AURAL SPECULA Black finish, diam, 38 mm Set of 4 5 mm
2623	133	HMI-GS-2600	GRUBER AURAL SPECULA Black finish, diam, 38 mm Set of 4 7 mm
2624	133	HMI-GS-2601	ROSEN Black finish, slotted round nds 35 mm Set of 4
2625	133	HMI-GS-2602	ROSEN Black finish, slotted round nds 35 mm Set of 4 3 mm
2626	133	HMI-GS-2603	ROSEN Black finish, slotted round nds 35 mm Set of 4 4 mm
2627	133	HMI-GS-2604	ROSEN Black finish, slotted round nds 35 mm Set of 4 5 mm
2628	133	HMI-GS-2605	ROSEN Black finish, slotted round nds 35 mm Set of 4 7 mm
2629	133	HMI-GS-2606	ROSEN slotted round ends Black finish, 35 mm Set of 4
2630	133	HMI-GS-2607	ROSEN slotted round ends Black finish, 35 mm Set of 4 4 mm
2631	133	HMI-GS-2608	ROSEN slotted round ends Black finish, 35 mm Set of 4 5 mm
2632	133	HMI-GS-2609	ROSEN slotted round ends Black finish, 35 mm Set of 4 6 mm
2633	133	HMI-GS-2610	ROSEN slotted round ends Black finish, 35 mm Set of 4 7 mm
2634	133	HMI-GS-2611	TUMARKIN Tapered Slot Size Set of 8
2635	133	HMI-GS-2612	TUMARKIN Tapered Slot Size Set of 8 0 4.5 mm
2636	133	HMI-GS-2613	TUMARKIN Tapered Slot Size Set of 8 1 6.5 mm









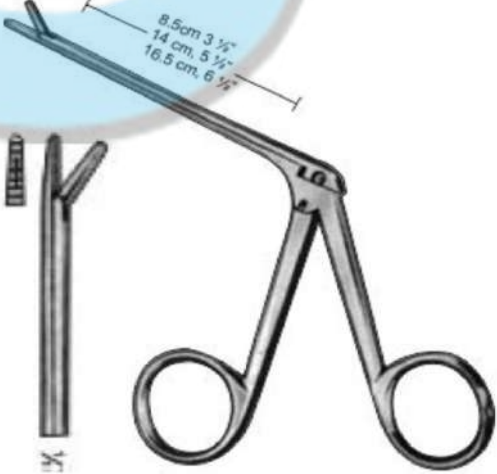

2637	133	HMI-GS-2614	TUMARKIN Tapered Slot Size Set of 8 2 7.0 mm
2638	133	HMI-GS-2615	TUMARKIN Tapered Slot Size Set of 8 3 7.5 mm
2639	133	HMI-GS-2616	TUMARKIN Tapered Slot Size Set of 8 4 8.0 mm
2640	133	HMI-GS-2617	TUMARKIN Tapered Slot Size Set of 8 5 8.5 mm
2641	133	HMI-GS-2618	TUMARKIN Tapered Slot Size Set of 8 6 9.0 mm
2642	133	HMI-GS-2619	TUMARKIN Tapered Slot Size Set of 8 7 11. mm
2643	133	HMI-GS-2620	SIEGLE Single Part: Diagnostic Head Complete Set
2644	133	HMI-GS-2621	SIEGLE Single Part: Aural magnifier, anastigmatic, complete with:
2645	133	HMI-GS-2622	SIEGLE 1 diagnostic head
2646	133	HMI-GS-2623	Ear Speculum, Ø 6.5 mm
2647	133	HMI-GS-2624	Ear Speculum, Ø 7 mm



2648	133	HMI-GS-2625	Ear Speculum, Ø 8 mm	
2649	133	HMI-GS-2626	1 rub bulb with rubber tube and connection cone	
2650	134	HMI-GS-2627	REINER Tip Only	
2651	134	HMI-GS-2628	REINER Tip Only	
2652	134	HMI-GS-2629	Shield	
2653	134	HMI-GS-2630	50CC Complete, 75CC Complete With Tip & Shield	
2654	134	HMI-GS-2631	100CC Complete, 150CC Complete With Tip & Shield	
2655	134	HMI-GS-2632	Hartmann Eustachian Catheters Ø 2 mm	







2656	134	HMI-GS-2633	Hartmann Eustachian Catheters Ø 2,5 mm	
2657	134	HMI-GS-2634	Hartmann Eustachian Catheters Ø 3 mm	
2658	134	HMI-GS-2635	Hartmann Eustachian Catheters Ø 4 mm	
2659	134	HMI-GS-2636	Hartmann Eustachian Catheters Ø 5 mm	
2660	134	HMI-GS-2637	POLITZER 16.5 cm, 6 1/2"	
2661	134	HMI-GS-2638	POLITZER 16.5 cm, 6 1/2" Needle Horizontal	
2662	134	HMI-GS-2639	GROSS	
2663	134	HMI-GS-2640	GROSS	

2664	134	HMI-GS-2641	COAKLEY SINUS CURETTES Straight angled 45° 24.5 cm, 10"	<p>Up Down</p> <p>12-270 Straight angled 45° 24.5 cm, 10"</p> <p>12-271 angled 45° 25.0 cm, 10"</p> <p>12-272 angled 90° 23.5 cm, 9 1/2"</p>
2665	134	HMI-GS-2642	COAKLEY SINUS CURETTES angled 45° 25.0 cm, 10"	
2666	134	HMI-GS-2643	COAKLEY SINUS CURETTES angled 90° 23.5 cm, 9 1/2"	
2667	134	HMI-GS-2644	KRAUSE-VOSS 25 cm, 10" Nasal Polypus Snare, knee shaped, complete	
2668	134	HMI-GS-2645	WILDE Nasal Polypus Snare, bayonet-shaped	
2669	135	HMI-GS-2646	TROELTSCH 11 cm, 4 1/2"	
2670	135	HMI-GS-2647	LUCAE 14 cm, 5 1/2"	
2671	135	HMI-GS-2648	QUIRE 12 cm, 4 3/4"	

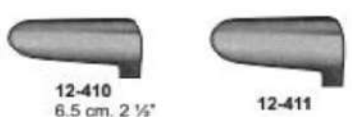
2672	135	HMI-GS-2649	HARTMANN 16 cm, 6 ¼"	
2673	135	HMI-GS-2650	HARTMANN 20 cm, 8"	
2674	135	HMI-GS-2651	HEYMANN-KNIGHT 18 cm, 7"	
2675	135	HMI-GS-2652	LUBET-BARBON 20 cm, 8"	
2676	136	HMI-GS-2653	HARTMANN-WULLSTEIN	
2677	136	HMI-GS-2654	HARTMANN-WULLSTEIN	
2678	136	HMI-GS-2655	HARTMANN	
2679	136	HMI-GS-2656	HARTMANN	

2680	136	HMI-GS-2657	HARTMANN
2681	136	HMI-GS-2658	HARTMANN
2682	136	HMI-GS-2659	HARTMANN-NOYES
2683	136	HMI-GS-2660	DUCKBILL
2684	136	HMI-GS-2661	WEINGÄRTNER
2685	136	HMI-GS-2662	HARTMANN = 2.0 mm
2686	136	HMI-GS-2663	HARTMANN = 2.5 mm
2687	136	HMI-GS-2664	HARTMANN = 3.0 mm





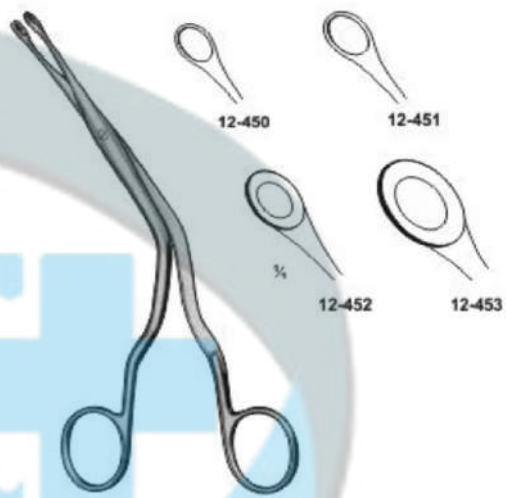

2688	136	HMI-GS-2665	HARTMANN = 2.0 mm	
2689	136	HMI-GS-2666	HARTMANN = 2.5 mm	
2690	136	HMI-GS-2667	HARTMANN = 3.0 mm	
2691	136	HMI-GS-2668	STRÜMPEL	
2692	136	HMI-GS-2669	HARTMAN	
2693	136	HMI-GS-2670	HARTMANN	
2694	136	HMI-GS-2671	HARTMANN-HOFFMANN	
2695	137	HMI-GS-2672	VIENNA NASAL SPECULUM 14 cm, 5 1/2" - Infant	









2696	137	HMI-GS-2673	VIENNA NASAL SPECULUM 14 cm, 5 1/2" - Child
2697	137	HMI-GS-2674	VIENNA NASAL SPECULUM 14 cm, 5 1/2" - Adult
2698	137	HMI-GS-2675	KILLIAN NASAL SPECULUM 35 mm 2" Small blade 13 cm, 5 1/4"
2699	137	HMI-GS-2676	KILLIAN NASAL SPECULUM 50 mm 3" Medium blade 13 cm, 5 1/4"
2700	137	HMI-GS-2677	KILLIAN NASAL SPECULUM 75 mm 13 cm, 5 1/4"
2701	137	HMI-GS-2678	KILLIAN NASAL SPECULUM 90 mm 13 cm, 5 1/4"
2702	137	HMI-GS-2679	THUDICHUM (Golfsmith) 6.5 cm, 2 1/2"
2703	137	HMI-GS-2680	THUDICHUM (Golfsmith) 6.5 cm, 2 1/2"





2704	137	HMI-GS-2681	THUDICHUM (Golfsmith) 6.5 cm, 2 1/2"
2705	137	HMI-GS-2682	THUDICHUM (Golfsmith) 6.5 cm, 2 1/2"
2706	137	HMI-GS-2683	THUDICHUM (Golfsmith) 6.5 cm, 2 1/2"
2707	137	HMI-GS-2684	ST-CLAIR THOMSON Fig 1
2708	137	HMI-GS-2685	ST-CLAIR THOMSON Fig 2
2709	137	HMI-GS-2686	ST-CLAIR THOMSON Fig 3
2710	137	HMI-GS-2687	VOLTOLINI (Duplay) Fig. 1
2711	137	HMI-GS-2688	VOLTOLINI (Duplay) Fig. 2





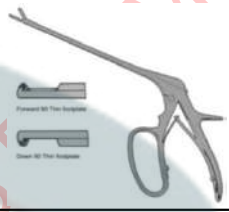















2712	137	HMI-GS-2689	VOLTOLINI (Duplay) Fig. 3	
2713	137	HMI-GS-2690	YANKAUER 19cm	
2714	138	HMI-GS-2691	LUC 20 cm, 8"	
2715	138	HMI-GS-2692	LUC 20 cm, 8"	
2716	138	HMI-GS-2693	LUC 20 cm, 8"	
2717	138	HMI-GS-2694	LUC 20 cm, 8"	
2718	138	HMI-GS-2695	BRUENINGS 19 cm, 7 1/2"	
2719	138	HMI-GS-2696	BRUENINGS 19 cm, 7 1/2"	

2720	138	HMI-GS-2697	BRUENINGS 19 cm, 7 1/2"	  
2721	138	HMI-GS-2698	BRUENINGS 19 cm, 7 1/2"	
2722	138	HMI-GS-2699	13 cm, 5 1/4" Straight 5 x 10 mm	
2723	138	HMI-GS-2700	WATSON-WILLIAMS	
2724	138	HMI-GS-2701	WATSON-WILLIAMS	
2725	138	HMI-GS-2702	WATSON-WILLIAMS	
2726	138	HMI-GS-2703	GRUENWALD-HENKE Nasal Cutting Forceps	
2727	138	HMI-GS-2704	GRUENWALD-HENKE Nasal Cutting Forceps	

2728	138	HMI-GS-2705	GRUENWALD-HENKE Nasal Cutting Forceps	
2729	138	HMI-GS-2706	GRUENWALD-HENKE Nasal Cutting Forceps	
2730	138	HMI-GS-2707	SCHMEDEN Nasal Cutting Forceps	
2731	138	HMI-GS-2708	STRUYCKEN Nasal Cutting Forceps	
2732	138	HMI-GS-2709	HARTMANN Nasal Cutting Forceps	
2733	138	HMI-GS-2710	HARTMANN Nasal Cutting Forceps	
2734	138	HMI-GS-2711	HARTMANN Nasal Cutting Forceps	
2735	138	HMI-GS-2712	HARTMANN Nasal Cutting Forceps	

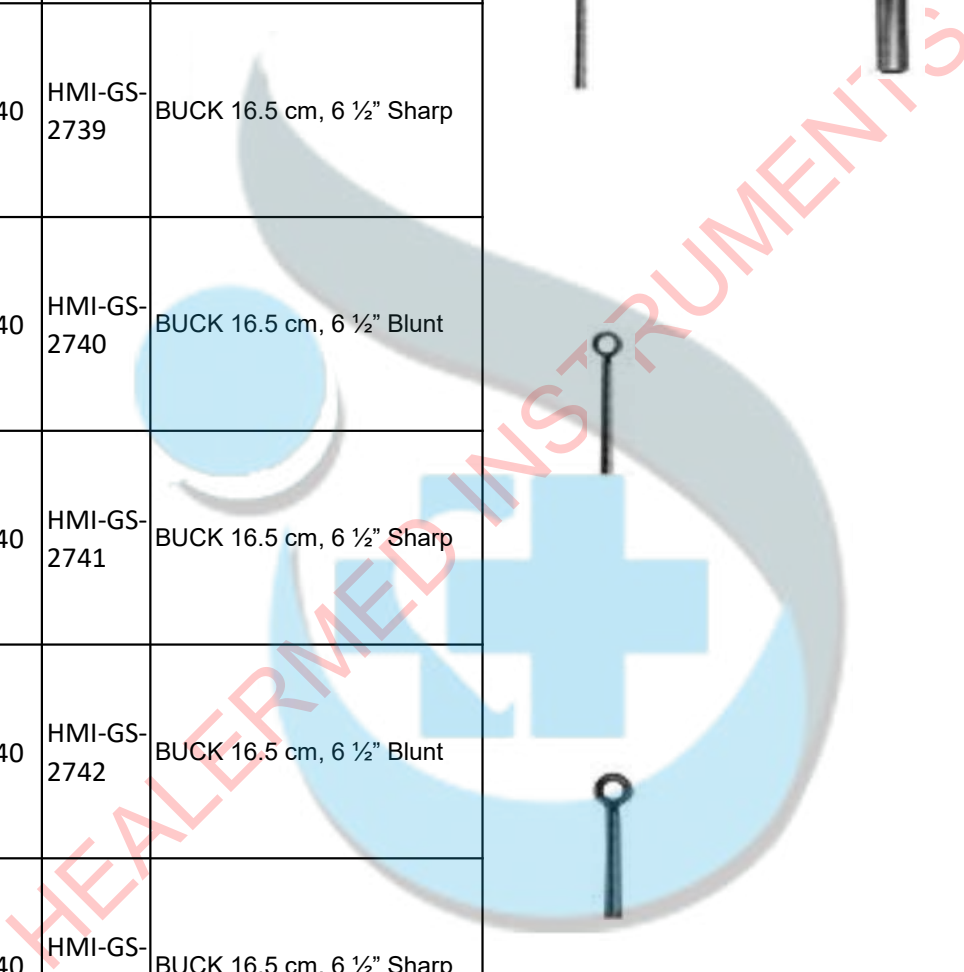
2736	139	HMI-GS-2713	HAJEK-KOFLER 90° Up-cutting Shaft Bite 2.0 mm 140 mm	<p>2.0 mm 3.0 mm 3.5 mm</p> <p>90° Up-cutting Shaft 140 mm Bite 2.0 mm 12-490 Bite 3.0 mm 12-491 Bite 3.5 mm 12-492</p> <p>90° Down-cutting Shaft 140 mm Bite 2.0 mm 12-493 Bite 3.0 mm 12-494 Bite 3.5 mm 12-495</p>
2737	139	HMI-GS-2714	HAJEK-KOFLER 90° Up-cutting Shaft Bite 3.0 mm 140 mm	
2738	139	HMI-GS-2715	HAJEK-KOFLER 90° Up-cutting Shaft Bite 3.5 mm 140 mm	
2739	139	HMI-GS-2716	HAJEK-KOFLER 90° Down-cutting Shaft Bite 2.0 mm 140 mm	
2740	139	HMI-GS-2717	HAJEK-KOFLER 90° Down-cutting Shaft Bite 3.0 mm 140 mm	
2741	139	HMI-GS-2718	HAJEK-KOFLER 90° Down-cutting Shaft Bite 3.5 mm 140 mm	
2742	139	HMI-GS-2719	KERRISON 9 cm, 3 1/2"	
2743	139	HMI-GS-2720	KERRISON 9 cm, 3 1/2" up cutting 3 x 3 mm	



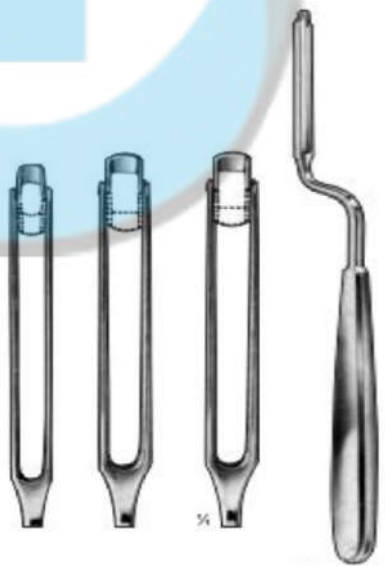
2744	139	HMI-GS-2721	KERRISON 9 cm, 3 1/2" up cutting 4 x 4 mm	<p>12-501 up cutting 4 x 4 mm</p>  <p>12-502 up cutting 5 x 5 mm</p>  <p>12-503 up cutting 6 x 6 mm</p>  
2745	139	HMI-GS-2722	KERRISON 9 cm, 3 1/2" up cutting 5 x 5 mm	
2746	139	HMI-GS-2723	KERRISON 9 cm, 3 1/2" up cutting 6 x 6 mm	
2747	139	HMI-GS-2724	FERRIS - SMITH Forward 90° Thin footplate, Down 90° Thin footplate	 <p>Forward 90° Thin footplate Down 90° Thin footplate</p>
2748	139	HMI-GS-2725	JANSEN-MIDDLETON 19 cm, 7 1/2" Double Action 5 x 15mm tip	 <p>19 cm / 7 1/2" Double Action 5 x 15mm tip JANSEN-MIDDLETON</p>
2749	140	HMI-GS-2726	ASCH 23 cm, 9"	
2750	140	HMI-GS-2727	WALSHAM 21 cm, 8 1/4" right	
2751	140	HMI-GS-2728	WALSHAM 21 cm, 8 1/4" left	 









2752	140	HMI-GS-2729	BRUNINGS 15.5 cm, 6 1/4" Septatome	
2753	140	HMI-GS-2730	FREER 15 cm, 6"	
2754	140	HMI-GS-2731	FREER 15.5 cm, 6 1/4" Mucous Knife	
2755	140	HMI-GS-2732	FREER 19 cm, 7 1/2" Respiratory sharp 4 mm	
2756	140	HMI-GS-2733	FREER 19 cm, 7 1/2" Respiratory sharp 4 mm	
2757	140	HMI-GS-2734	BUCK 16.5 cm, 6 1/2" Blunt	
2758	140	HMI-GS-2735	BUCK 16.5 cm, 6 1/2" Sharp	
2759	140	HMI-GS-2736	BUCK 16.5 cm, 6 1/2" Blunt	















2760	140	HMI-GS-2737	BUCK 16.5 cm, 6 1/2" Sharp
2761	140	HMI-GS-2738	BUCK 16.5 cm, 6 1/2" Blunt
2762	140	HMI-GS-2739	BUCK 16.5 cm, 6 1/2" Sharp
2763	140	HMI-GS-2740	BUCK 16.5 cm, 6 1/2" Blunt
2764	140	HMI-GS-2741	BUCK 16.5 cm, 6 1/2" Sharp
2765	140	HMI-GS-2742	BUCK 16.5 cm, 6 1/2" Blunt
2766	140	HMI-GS-2743	BUCK 16.5 cm, 6 1/2" Sharp
2767	140	HMI-GS-2744	BUCK 16.5 cm, 6 1/2" Blunt



















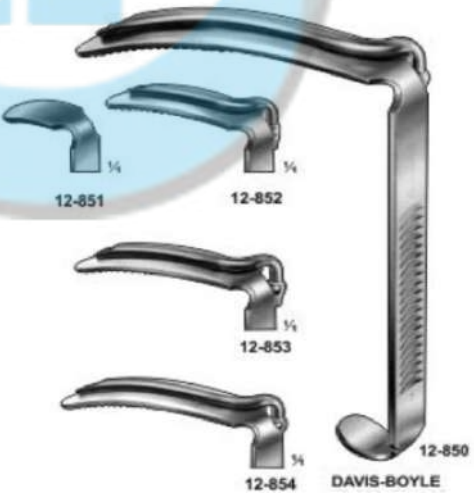
2768	140	HMI-GS-2745	BUCK 16.5 cm, 6 1/2" Sharp			
2769	140	HMI-GS-2746	BUCK 16.5 cm, 6 1/2" Blunt			
2770	140	HMI-GS-2747	BUCK 16.5 cm, 6 1/2" Sharp			
2771	140	HMI-GS-2748	BUCK 16.5 cm, 6 1/2" Blunt			
2772	140	HMI-GS-2749	BUCK 16.5 cm, 6 1/2" Sharp			
2773	140	HMI-GS-2750	BALLENGER 4 x 3 mm 20 cm, 8" Swivel Knife, bayonet-shaped			
2774	140	HMI-GS-2751	BALLENGER 5 x 4 mm 20 cm, 8" Swivel Knife, bayonet-shaped			
2775	140	HMI-GS-2752	BALLENGER 6 x 5 mm 20 cm, 8" Swivel Knife, bayonet-shaped			




2776	141	HMI-GS-2753	FREER 16 cm, 6 ¼" 4 mm wide Septum Chisel, straight	
2777	141	HMI-GS-2754	FREER 16 cm, 6 ¼" 4 mm wide Septum Chisel, curved	
2778	141	HMI-GS-2755	FREER 15 cm, 6" 6 mm wide Septum Gouge, straight	
2779	141	HMI-GS-2756	BALLENGER 15.5 cm, 6" 6 mm wide Septum Gouge	
2780	141	HMI-GS-2757	KILLIAN 17 cm, 6 ¾" 5 mm wide Septum Gouge	
2781	141	HMI-GS-2758	FREER 19cm 7 ½" blunt	
2782	141	HMI-GS-2759	FREER 18cm 7" sharp	
2783	141	HMI-GS-2760	EICKEN-KILLIAN 3mmØ	





2784	141	HMI-GS-2761	KILLIAN 1.5cmØ	
2785	141	HMI-GS-2762	HARTMANN 1.5cmØ	
2786	141	HMI-GS-2763	HARTMANN 2mmØ	
2787	141	HMI-GS-2764	HARTMANN 2.5mmØ	
2788	141	HMI-GS-2765	HARTMANN 3mmØ	
2789	142	HMI-GS-2766	Beckmann 22 cm, 8 3/4"	
2790	142	HMI-GS-2767	Beckmann 22 cm, 8 3/4"	
2791	142	HMI-GS-2768	Beckmann 22 cm, 8 3/4"	





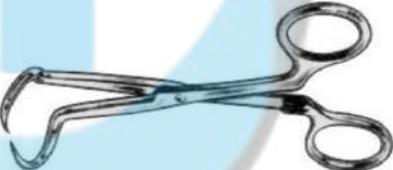


2792	142	HMI-GS-2769	Beckmann 22 cm, 8 3/4"	
2793	142	HMI-GS-2770	Beckmann 22 cm, 8 3/4"	
2794	142	HMI-GS-2771	Beckmann 22 cm, 8 3/4"	
2795	142	HMI-GS-2772	ST. CLAIR-THOMSON 21cm, 8 1/4"	
2796	142	HMI-GS-2773	ST. CLAIR-THOMSON 21cm, 8 1/4"	
2797	142	HMI-GS-2774	ST. CLAIR-THOMSON 21cm, 8 1/4"	
2798	142	HMI-GS-2775	ST. CLAIR-THOMSON 21cm, 8 1/4"	
2799	142	HMI-GS-2776	LA FORCEPS Adenotomes 23 cm, 9"	

2800	142	HMI-GS-2777	LA FORCEPS Adenotomes 23 cm, 9"		
2801	142	HMI-GS-2778	LA FORCEPS Adenotomes 23 cm, 9"		
2802	142	HMI-GS-2779	JOSEPH		
2803	142	HMI-GS-2780	JOSEPH		
2804	143	HMI-GS-2781	MOLT 11 cm, 4 1/2"		
2805	143	HMI-GS-2782	DOYEN-COLLIN Mout Gag 12 cm, 5"		
2806	143	HMI-GS-2783	DOYEN-COLLIN Mout Gag 14 cm, 5 1/2"		
2807	143	HMI-GS-2784	FERGUSON-ACKLAND 14.5 cm, 5 3/4"		








2808	143	HMI-GS-2785	DENHARDT 12.5 cm, 5" Mouth Gag with silicon inserts, interchangeable	
2809	143	HMI-GS-2786	ROSER-KONIG 16 cm, 6 1/4" Mouth Gag	
2810	143	HMI-GS-2787	HEISTER 13 cm, 5" Mouth Gag	
2811	144	HMI-GS-2788	DAVIS-BOYLE Complete Set Double Bite-Lift Side Gag only left side	
2812	144	HMI-GS-2789	DAVIS-BOYLE 20 X 25mm Tongue Blades only.	 <p>12-851 12-852</p> <p>12-853</p> <p>12-854 DAVIS-BOYLE</p>
2813	144	HMI-GS-2790	DAVIS-BOYLE 22 X 60mm Tongue Blades only.	
2814	144	HMI-GS-2791	DAVIS-BOYLE 25 X 75mm Tongue Blades only.	
2815	144	HMI-GS-2792	DAVIS-BOYLE 25 X 90mm Tongue Blades only.	


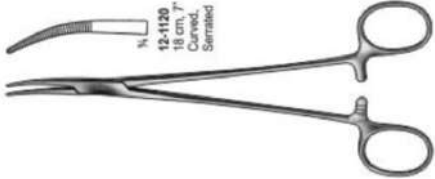
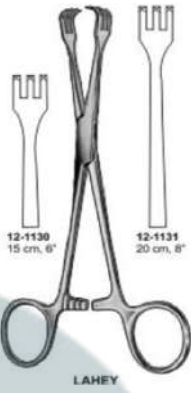
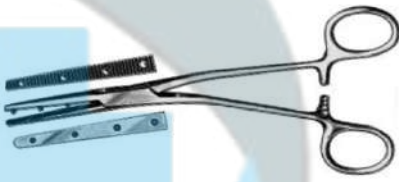


2816	144	HMI-GS-2793	DAVIS-BOYLE 27 X 105mm Tongue Blades only.	
2817	144	HMI-GS-2794	HEISTER 12 cm, 4.75" Mouth Gag	
2818	144	HMI-GS-2795	WHITEHEAD-JENNINGS Mouth Gag 9 cm, 3 1/2"	
2819	144	HMI-GS-2796	WHITEHEAD-JENNINGS Mouth Gag 11 cm, 4 1/4"	
2820	144	HMI-GS-2797	WHITEHEAD-JENNINGS Mouth Gag 13 cm , 5"	
2821	144	HMI-GS-2798	WHITEHEAD-JENNINGS Mouth Gag 15 cm , 6"	
2822	144	HMI-GS-2799	WHITEHEAD Mouth Gag with tongue depressor 11 cm, 4 1/4"	
2823	144	HMI-GS-2800	WHITEHEAD Mouth Gag with tongue depressor 13 cm , 5"	








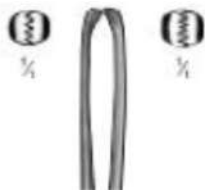
2824	144	HMI-GS-2801	WHITEHEAD Mouth Gag with tongue depressor 15 cm , 6"	
2825	144	HMI-GS-2802	WHITEHEAD Mouth Gag 9 cm, 3 1/2"	
2826	144	HMI-GS-2803	WHITEHEAD Mouth Gag 11 cm, 4 1/4"	
2827	144	HMI-GS-2804	WHITEHEAD Mouth Gag 13 cm , 5"	
2828	144	HMI-GS-2805	WHITEHEAD Mouth Gag 15 cm , 6"	
2829	145	HMI-GS-2806	BUCHWALD Tongue Depressor 18 cm, 7"	
2830	145	HMI-GS-2807	BRUENINGS Tongue Depressor 19 cm, 7 1/2"	
2831	145	HMI-GS-2808	TONGUE DEPRESSOR 14.5 cm, 5 3/4"	



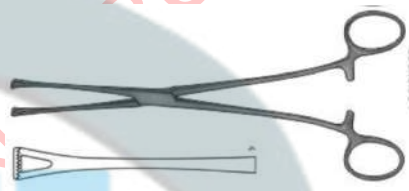

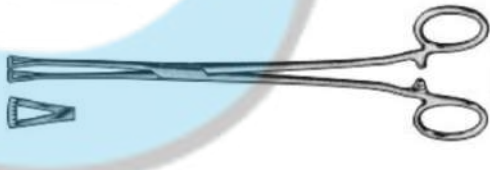


2832	145	HMI-GS-2809	TONGUE DEPRESSOR 14.5 cm, 5 3/4"	
2833	145	HMI-GS-2810	WEIDER 14.5 cm, 5 1/2" serrated 28 mm	
2834	145	HMI-GS-2811	WEIDER 14.5 cm, 5 1/2" serrated 32 mm	
2835	145	HMI-GS-2812	TOBOLD 14.5 cm, 5 3/4"	
2836	145	HMI-GS-2813	TONGUE DEPRESSORS	
2837	146	HMI-GS-2814	CARMALT 12.5 cm, 5"	
2838	146	HMI-GS-2815	CARBOULD 14 cm, 5 1/2"	
2839	146	HMI-GS-2816	COLLIN	





2840	146	HMI-GS-2817	COLLIN 16cm, 6 ¼"	<p>12-991 16cm, 6 ¼" 12-992 16cm, 6 ¼" 12-993 17cm, 6 ¾"</p>
2841	146	HMI-GS-2818	COLLIN 16cm, 6 ¼"	
2842	146	HMI-GS-2819	COLLIN 17cm, 6 ¾"	
2843	146	HMI-GS-2820	GUY 16 cm, 6"	<p>GUY</p>
2844	146	HMI-GS-2821	MATHIEU 19 cm, 7 ½"	<p>MATHIEU</p>
2845	146	HMI-GS-2822	YOUNG 16 cm, 6 ¼"	<p>12-1021 pair</p>
2846	146	HMI-GS-2823	YOUNG 16 cm, 6 ¼" pair	<p>YOUNG</p>
2847	147	HMI-GS-2824	BROPHY 19 cm	

2848	147	HMI-GS-2825	LYNCH 20 cm	
2849	147	HMI-GS-2826	DUPUY-WEISS 22 cm	
2850	147	HMI-GS-2827	HURD 22.5 cm	
2851	147	HMI-GS-2828	WEIDER 21.5 cm	
2852	147	HMI-GS-2829	TIVNEN TONSIL SEIZING FORCEPS Guard on lock prevents over-riding of 3 x 3 prongs. 21.6 cm, 8 1/2"	
2853	147	HMI-GS-2830	WHITE 18 cm, 7"	
2854	147	HMI-GS-2831	WHITE 23 cm, 9"	
2855	147	HMI-GS-2832	COLVER 19 cm	

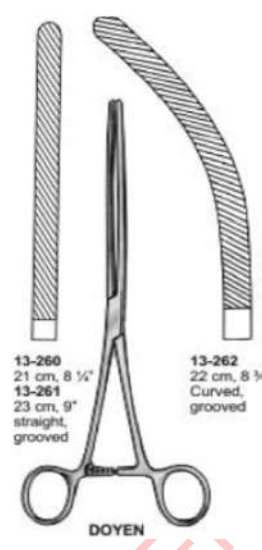
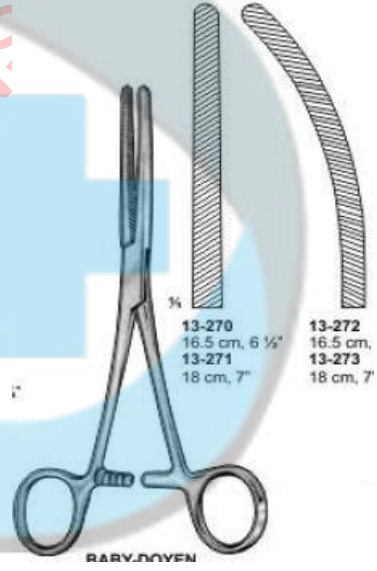
2856	147	HMI-GS-2833	BALLENGER 21.5 cm	
2857	147	HMI-GS-2834	SCHNIDT / SAWTELL 18 cm, 7" Curved, Serrated	
2858	148	HMI-GS-2835	LAHEY 15 cm, 6"	
2859	148	HMI-GS-2836	LAHEY 20 cm, 8"	
2860	148	HMI-GS-2837	Mastin 17cm 6 3/4"	
2861	148	HMI-GS-2838	Schoemaker 15cm 6"	
2862	148	HMI-GS-2839	Kocher 15cm 6"	
2863	148	HMI-GS-2840	Kocher 16cm 6 1/4"	




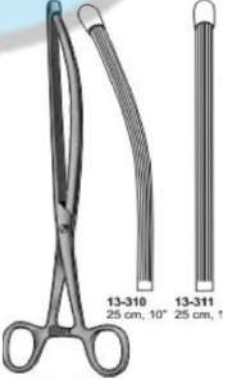
2864	148	HMI-GS-2841	Kocher	
2865	148	HMI-GS-2842	Unna 14cm 5 1/2"	
2866	148	HMI-GS-2843	Unna 14cm 5 1/2"	
2867	148	HMI-GS-2844	GILLIES 18 cm, 7" Sharp	
2868	148	HMI-GS-2845	GILLIES 18 cm, 7" sharp	
2869	148	HMI-GS-2846	KILNER 15 cm, 6" blunt	
2870	148	HMI-GS-2847	Allis 15cm 4:5	
2871	148	HMI-GS-2848	Allis 15cm 6"	



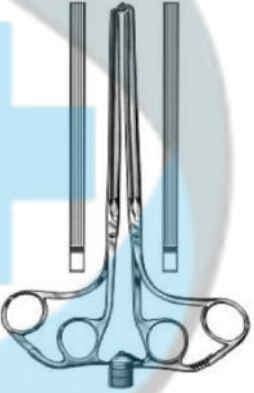


2872	148	HMI-GS-2849	Allis 19cm 7 1/2"	
2873	148	HMI-GS-2850	Allis 25cm 10"	
2874 2875	INTESTINAL INSTF			
2876	149	HMI-GS-2851	ALLIS 20.0 cm, 8"	
2877	149	HMI-GS-2852	LOCKWOOD 20.0 cm, 8"	
2878	149	HMI-GS-2853	ALLIS ADAIR 15.5 cm	
2879	149	HMI-GS-2854	LOCKWOOD 20cm 8"	
2880	149	HMI-GS-2855	JUDD-ALLIS 3 x 4 teeth 19.5 cm, 7 3/4"	
2881	149	HMI-GS-2856	LITTLEWOOD 19 cm, 7 1/2"	



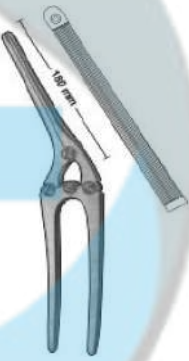

2882	149	HMI-GS-2857	STILLE 20 cm, 8"	
2883	149	HMI-GS-2858	LANE 12.5 cm	
2884	149	HMI-GS-2859	LANE 15.0 cm	
2885	149	HMI-GS-2860	LANE 19.0 cm	
2886	150	HMI-GS-2861	LANE 12.7 cm, 5"	
2887	150	HMI-GS-2862	LANE 15 cm, 6"	
2888	150	HMI-GS-2863	LANE 19 cm, 7 1/2"	
2889	150	HMI-GS-2864	BABCOCK 16.0 cm, 6 1/4"	






2890	150	HMI-GS-2865	BABCOCK 21.5 cm, 8 1/4"	
2891	150	HMI-GS-2866	CHAPUT 2 x 3 teeth, sharp 12.5 cm, 5"	
2892	150	HMI-GS-2867	PERCY 24.0 cm, 9 1/4"	
2893	150	HMI-GS-2868	DENNIS-BROWN 18.0 cm, 7"	
2894	150	HMI-GS-2869	DUVAL 18cm 7"	
2895	150	HMI-GS-2870	DUVAL 20cm 8"	
2896	150	HMI-GS-2871	COLLIN 23.0 cm, 9"	
2897	151	HMI-GS-2872	KOCHER 22 cm, 8 3/4" Straight	












2898	151	HMI-GS-2873	DOYEN 21 cm, 8 ¼"	 <p>13-260 21 cm, 8 ¼" 13-261 23 cm, 9" straight, grooved</p> <p>13-262 22 cm, 8 ½" Curved, grooved</p> <p>DOYEN</p>
2899	151	HMI-GS-2874	DOYEN 23 cm, 9" straight, grooved	
2900	151	HMI-GS-2875	DOYEN 22 cm, 8 ¾" Curved, grooved	
2901	151	HMI-GS-2876	BABY-DOYEN 16.5 cm, 6 ½"	 <p>13-270 16.5 cm, 6 ½" 13-271 18 cm, 7" 13-272 16.5 cm,</p> <p>BABY-DOYEN</p>
2902	151	HMI-GS-2877	BABY-DOYEN 18 cm, 7"	
2903	151	HMI-GS-2878	BABY-DOYEN 16.5 cm, 6 ½"	
2904	151	HMI-GS-2879	BABY-DOYEN 18 cm, 7"	
2905	151	HMI-GS-2880	KOCHER-ATRAUMA 22cm 8 3/4"	

2906	151	HMI-GS-2881	KOCHER-ATRAUMA 25cm 10"	
2907	151	HMI-GS-2882	KOCHER-ATRAUMA 28cm 11"	
2908	151	HMI-GS-2883	KOCHER Cvd. 22cm 8 3/4"	
2909	151	HMI-GS-2884	KOCHER Cvd. 25cm 10"	
2910	151	HMI-GS-2885	KOCHER Cvd. 28cm 11"	
2911	151	HMI-GS-2886	SCUDDER 25cm 10"	
2912	151	HMI-GS-2887	NUSSBAUM 25 cm, 10"	 <p>13-310 25 cm, 10" 13-311 25 cm, 10"</p>
2913	151	HMI-GS-2888	NUSSBAUM 25 cm, 10"	

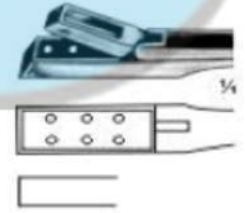
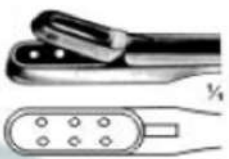
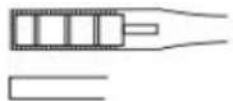
2914	151	HMI-GS-2889	MIKULICZ 8cm 3 1/4"	
2915	151	HMI-GS-2890	MIKULICZ 12cm 4 3/4"	
2916	151	HMI-GS-2891	MIKULICZ 19cm 7 1/2"	
2917	152	HMI-GS-2892	LANE Cvd. 30 cm, 12"	
2918	152	HMI-GS-2893	ABADIE 22cm 8 3/4"	
2919	152	HMI-GS-2894	ABADIE 27cm 10 1/2"	
2920	152	HMI-GS-2895	LANE 30 cm, 12"	
2921	152	HMI-GS-2896	LANE Cvd. 30 cm, 12"	

2922	152	HMI-GS-2897	PAYR-BABY 15 cm, 6" without pin	 <p>PAYR-BABY 13-370 15 cm, 6" without pin 13-371 15 cm, 6" with pin</p>
2923	152	HMI-GS-2898	PAYR-BABY 15 cm, 6" with pin	
2924	152	HMI-GS-2899	PAYR 21 cm, 8 1/4" without pin	 <p>PAYR 13-380 21 cm, 8 1/4" without pin 13-381 21 cm, 8 1/4" with pin</p>
2925	152	HMI-GS-2900	PAYR 21 cm, 8 1/4" with pin	
2926	152	HMI-GS-2901	PAYR 29 cm, 11 1/2" without pin	
2927	152	HMI-GS-2902	PAYR 29 cm, 11 1/2" with pin	
2928	152	HMI-GS-2903	PAYR 35 cm, 13 3/4" without pin	
2929	152	HMI-GS-2904	PAYR 35 cm, 13 3/4" with pin	

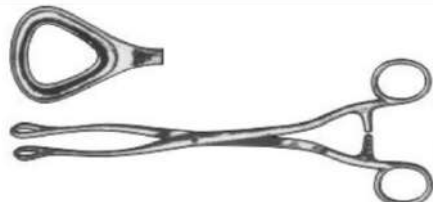



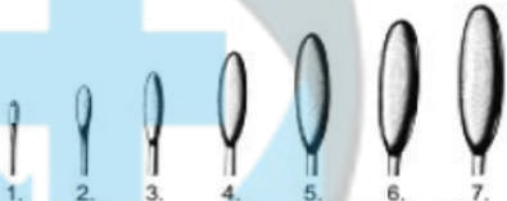

2930	153	HMI-GS-2905	MATHIEU 19.5 cm, 7 3/4" 90 x 15 mm	
2931	153	HMI-GS-2906	SIMS 15 cm, 6"	
2932	153	HMI-GS-2907	SIMS 15 cm, 6"	
2933	153	HMI-GS-2908	Sims 15 cm, 6"	
2934	153	HMI-GS-2909	KELLY 22 ø x 50 mm	
2935	153	HMI-GS-2910	KELLY 22 ø x 100 mm	
2936	153	HMI-GS-2911	KELLY 22 ø x 140 mm	
2937	153	HMI-GS-2912	KELLY 22 ø x 200 mm	

2938	153	HMI-GS-2913	GABRIEL 64 x 24 mm	 <p>GABRIEL 13-460 64 x 24 mm 13-461 64 x 19 mm</p>
2939	153	HMI-GS-2914	GABRIEL 64 x 19 mm	
2940	153	HMI-GS-2915	NAUTON-MORGAN 64 x 24 mm	
2941	153	HMI-GS-2916	NAUTON-MORGAN 64 x 19 mm	
2942	154	HMI-GS-2917	YEOMANN 28 cm, 11"	        
2943	154	HMI-GS-2918	YEOMANN 35 cm, 13 3/4"	
2944	154	HMI-GS-2919	YEOMANN 42 cm, 16 1/4"	
2945	154	HMI-GS-2920	YEOMANN 28 cm, 11"	

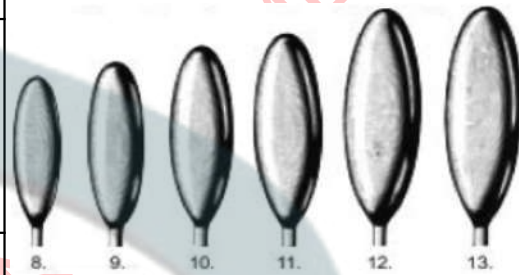
2946	154	HMI-GS-2921	YEOMANN 35 cm, 13 3/4"
2947	154	HMI-GS-2922	YEOMANN 42 cm, 16 1/4"
2948	154	HMI-GS-2923	YEOMANN 28 cm, 11"
2949	154	HMI-GS-2924	YEOMANN 35 cm, 13 3/4"
2950	154	HMI-GS-2925	YEOMANN 42 cm, 16 1/4"
2951	154	HMI-GS-2926	YEOMANN 28 cm, 11"
2952	154	HMI-GS-2927	YEOMANN 35 cm, 13 3/4"
2953	154	HMI-GS-2928	YEOMANN 42 cm, 16 1/4"




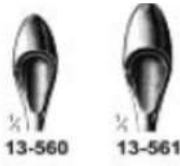



HEALER MEDICAL INSTRUMENTS



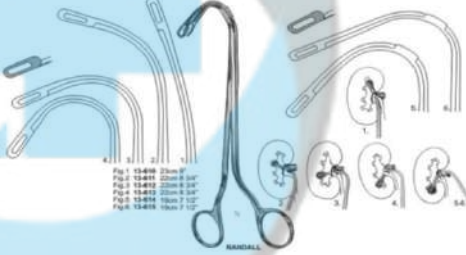
2954	154	HMI-GS-2929	LURE 24.5cm	
2955	154	HMI-GS-2930	JARVIS PILE FORCEPS 23cm	
2956	154	HMI-GS-2931	LANGENBECK 45cm	
2957	154	HMI-GS-2932	COTTON CARRIER 45cm	
2958	155	HMI-GS-2933	1. BAKES 30cm 12"	 
2959	155	HMI-GS-2934	2. BAKES 30cm 12"	
2960	155	HMI-GS-2935	3. BAKES 30cm 12"	
2961	155	HMI-GS-2936	4. BAKES 30cm 12"	



2962	155	HMI-GS-2937	5. BAKES 30cm 12"
2963	155	HMI-GS-2938	6. BAKES 30cm 12"
2964	155	HMI-GS-2939	7. BAKES 30cm 12"
2965	155	HMI-GS-2940	8. BAKES 30cm 12"
2966	155	HMI-GS-2941	9. BAKES 30cm 12"
2967	155	HMI-GS-2942	10. BAKES 30cm 12"
2968	155	HMI-GS-2943	11. BAKES 30cm 12"
2969	155	HMI-GS-2944	12. BAKES 30cm 12"











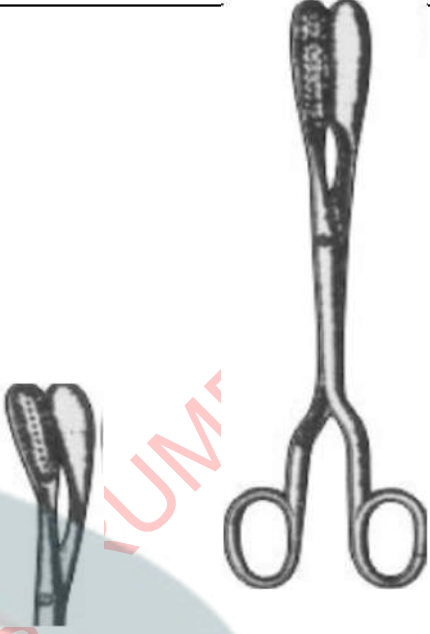




HEALER MEDICALS



2970	155	HMI-GS-2945	13. BAKES 30cm 12"		
2971	155	HMI-GS-2946	DESJARDINS 30cm 12"		
2972	155	HMI-GS-2947	DESJARDINS 30cm 12"		
2973	155	HMI-GS-2948	DESJARDINS 30cm 12"		
2974	155	HMI-GS-2949	DESJARDINS 30cm 12"		
2975	155	HMI-GS-2950	MAYO 28cm 11"		
2976	155	HMI-GS-2951	BLAKE 20cm 8"		
2977	155	HMI-GS-2952	BLAKE 20cm 8"		



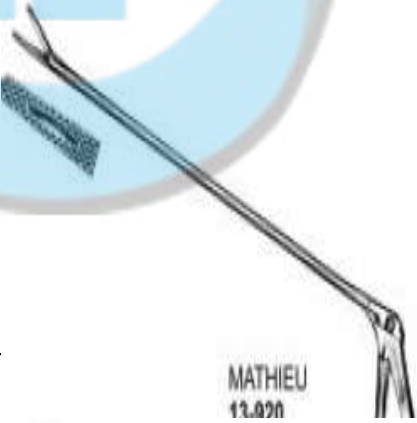
2978	155	HMI-GS-2953	MAYO-BLAKE 20cm 8"	
2979	155	HMI-GS-2954	DESJARDINS 23cm 9"	
2980	156	HMI-GS-2955	RANDALL Fig.1 23cm 9"	 <p>Fig. 1 23cm 9" Fig. 2 22cm 8 3/4" Fig. 3 22cm 8 3/4" Fig. 4 22cm 8 3/4" Fig. 5 19cm 7 1/2" Fig. 6 19cm 7 1/2"</p>
2981	156	HMI-GS-2956	RANDALL Fig.2 22cm 8 3/4"	
2982	156	HMI-GS-2957	RANDALL Fig.3 22cm 8 3/4"	
2983	156	HMI-GS-2958	RANDALL Fig.4 22cm 8 3/4"	
2984	156	HMI-GS-2959	RANDALL Fig.5 19cm 7 1/2"	
2985	156	HMI-GS-2960	RANDALL Fig.6 19cm 7 1/2"	



2986	156	HMI-GS-2961	CATHETER 15 cm, 6" No. 6-16	
2987	156	HMI-GS-2962	CATHETERS 29 cm, 11 1/2" Male Catheters charr., Metal	
2988	156	HMI-GS-2963	CATHETERS 29 cm, 11 1/2" Male Catheters charr., Metal French 8	
2989	156	HMI-GS-2964	CATHETERS 29 cm, 11 1/2" Male Catheters charr., Metal French 10	
2990	156	HMI-GS-2965	CATHETERS 29 cm, 11 1/2" Male Catheters charr., Metal French 12	
2991	156	HMI-GS-2966	CATHETERS 29 cm, 11 1/2" Male Catheters charr., Metal French 14	
2992	156	HMI-GS-2967	CATHETERS 29 cm, 11 1/2" Male Catheters charr., Metal French 16	
2993	156	HMI-GS-2968	CATHETERS 29 cm, 11 1/2" Male Catheters charr., Metal French 18	





2994	156	HMI-GS-2969	CATHETERS 29 cm, 11 ½" Male Catheters charr., Metal French 20	
2995	156	HMI-GS-2970	COXETER 28 cm 8 Fg To 24 Fg	
2996	156	HMI-GS-2971	20 cm 8 Fg To 24 Fg	
2997	157	HMI-GS-2972	LISTER 00/1 to 15/18	
2998	157	HMI-GS-2973	CLUTTON 6/10fg. To 28/32f.g	
2999	157	HMI-GS-2974	STONE 6eg. To 12eg	
3000	157	HMI-GS-2975	WHEELHOUSE	
3001	157	HMI-GS-2976	CHILD Directors	



2985	157	HMI-GS-2977	KEY	
2986	157	HMI-GS-2978	LEWKOWITZ 26 cm	
2987	157	HMI-GS-2979	LEWKOWITZ 26 cm	
2988	157	HMI-GS-2980	LEWKOWITZ 26 cm	
2989	157	HMI-GS-2981	YOUNG 20 cm	
2990	158	HMI-GS-2982	LEGUEU 17 cm, 6 3/4"	
2991	158	HMI-GS-2983	MILLIN	
2992	158	HMI-GS-2984	MILLIN 28 cm, 11"	




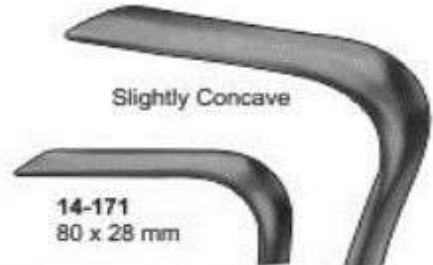
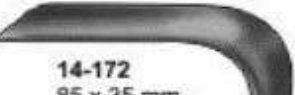
2993	158	HMI-GS-2985	KNUTSON 18 cm, 7" Urethrographie-Instruments	
2994	158	HMI-GS-2986	GUMCO CLAMP mm ø 8	
2995	158	HMI-GS-2987	GUMCO CLAMP mm ø 11	
2996	158	HMI-GS-2988	GUMCO CLAMP mm ø 13	
2997	158	HMI-GS-2989	GUMCO CLAMP mm ø 16	
2998	158	HMI-GS-2990	GUMCO CLAMP mm ø 21	
2999	158	HMI-GS-2991	GUMCO CLAMP mm ø 26	
3000	158	HMI-GS-2992	GUMCO CLAMP mm ø 32	

3001	158	HMI-GS-2993	WINKELMANN	
3002	158	HMI-GS-2994	WINKELMANN	
3003	158	HMI-GS-2995	WINKELMANN	
3001	158	HMI-GS-2996	MILLIN 23 cm, 9"	
3002	158	HMI-GS-2997	MILLIN 23 cm, 9"	
3003	158	HMI-GS-2998	MATHIEU 20cm 8"	 <p>MATHIEU 11.070</p>
3004	158	HMI-GS-2999	MATHIEU 28cm 11"	
3005	158	HMI-GS-3000	MATHIEU 20cm 8"	

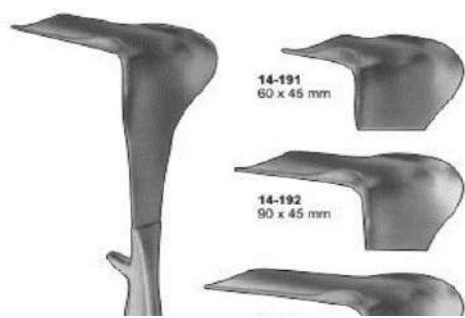
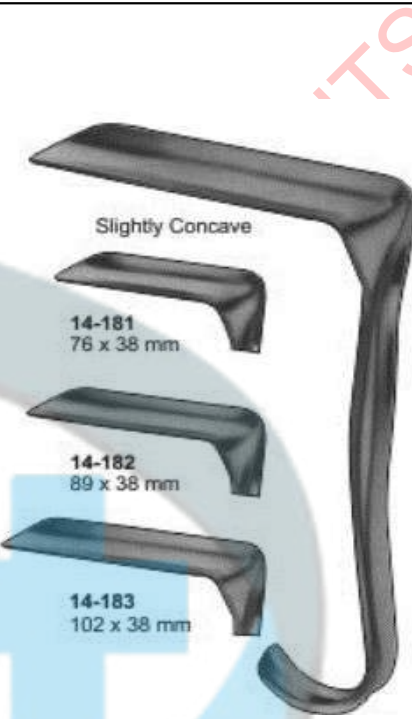
3006	158	HMI-GS-3001	MATHIEU 28cm 11"	<p>MATHIEU 13-930 20cm 8" 13-931 28cm 11"</p> 
3007				GYNECOLOGY
3008				
3009	159	HMI-GS-3002	CUSCO 75 x 32 mm	
3010	159	HMI-GS-3003	CUSCO 85 x 35 mm	
3011	159	HMI-GS-3004	CUSCO 100 x 35 mm	
3012	159	HMI-GS-3005	CUSCO 90 x 22 mm	
3013	159	HMI-GS-3006	CUSCO 100 x 25 mm	
3014	159	HMI-GS-3007	CUSCO 105 x 27 mm	
3015	159	HMI-GS-3008	GRAVES 75 x 20 mm Small	


3016	159	HMI-GS-3009	GRAVES 95 x 35 mm Medium	
3017	159	HMI-GS-3010	GRAVES 115 x 35 mm Large	
3018	159	HMI-GS-3011	COLLIN 85 x 30 mm	
3019	159	HMI-GS-3012	COLLIN 100 x 35 mm	
3020	159	HMI-GS-3013	COLLIN 110 x 40 mm	
3021	159	HMI-GS-3014	COLLIN 55 x 10 mm	
	159	HMI-GS-3015	WINTERTON	
	159	HMI-GS-3016	PEDERSON 75 x 13 mm Small	




	159	HMI-GS-3017	PEDERSON 100 x 22 mm Medium	
	159	HMI-GS-3018	PEDERSON 120 x 25 mm Large	
3025	159	HMI-GS-3019	Graves Vaginal Speculum Leep / Lietz Small	
3026	159	HMI-GS-3020	Graves Vaginal Speculum Leep / Lietz Medium	
3027	159	HMI-GS-3021	Graves Vaginal Speculum Leep / Lietz Large	
3028	159	HMI-GS-3022	Graves Vaginal Speculum Leep / Lietz X-large	
3029	159	HMI-GS-3023	Pederson Vaginal Speculum Leep / Lietz Small	
3030	159	HMI-GS-3024	Pederson Vaginal Speculum Leep / Lietz Medium	
3031	159	HMI-GS-3025	Pederson Vaginal Speculum Leep / Lietz Large	
3032	159	HMI-GS-3026	Pederson Vaginal Speculum Leep / Lietz X-Large	

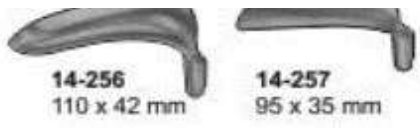


3033	159	HMI-GS-3027	CUSCO Small	
3034	159	HMI-GS-3028	CUSCO Medium	
3035	159	HMI-GS-3029	CUSCO Large	
3036	159	HMI-GS-3030	SAKURAS Small	
3037	159	HMI-GS-3031	SAKURAS Medium	
3038	159	HMI-GS-3032	SAKURAS Large	
3039	160	HMI-GS-3033	KRISTELLER 110x18 mm 22.0 cm,	
3040	160	HMI-GS-3034	KRISTELLER 110x20 mm 22.0 cm,	
3041	160	HMI-GS-3035	KRISTELLER 110x27 mm 22.0 cm,	
3042	160	HMI-GS-3036	KRISTELLER 110x30 mm 22.0 cm,	
3043	160	HMI-GS-3037	KRISTELLER 110x36 mm 22.0 cm,	
3044	160	HMI-GS-3038	KRISTELLER 20.5 cm, 8" Slightly Concave	
3045	160	HMI-GS-3039	KRISTELLER 20.5 cm, 8" Slightly Concave 80 x 28 mm	 <p>Slightly Concave</p> <p>14-171 80 x 28 mm</p>  <p>14-172 85 x 25 mm</p>





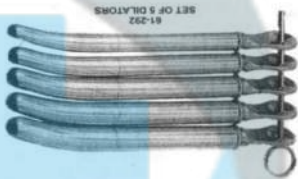

3046	160	HMI-GS-3040	KRISTELLER 20.5 cm, 8" Slightly Concave 85 x 35 mm
3047	160	HMI-GS-3041	KRISTELLER 20.5 cm, 8" Slightly Concave 85 x 40 mm
3048	160	HMI-GS-3042	JACKSON 17.5 cm, 7" Slightly Concave
3049	160	HMI-GS-3043	JACKSON 17.5 cm, 7" Slightly Concave 76 x 38 mm
3050	160	HMI-GS-3044	JACKSON 17.5 cm, 7" Slightly Concave 89 x 38 mm
3051	160	HMI-GS-3045	JACKSON 17.5 cm, 7" Slightly Concave 102 x 38 mm
3052	160	HMI-GS-3046	DOYEN 23.5 cm, 9 ¼"
3053	160	HMI-GS-3047	DOYEN 23.5 cm, 9 ¼" 60 x 45 mm















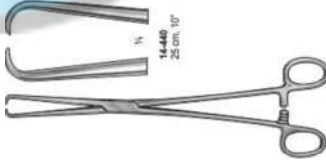

3054	160	HMI-GS-3048	DOYEN 23.5 cm, 9 ¼" 90 x 45 mm	 <p>14-193 112 x 45 mm</p> 
3055	160	HMI-GS-3049	DOYEN 23.5 cm, 9 ¼" 112 x 45 mm	
3056	160	HMI-GS-3050	SIMS-KELLY 24 cm, 9 ½" 57 x 25 mm	
3057	160	HMI-GS-3051	SIMS-KELLY 24 cm, 9 ½" 69 x 45 mm	
3058	160	HMI-GS-3052	SIMS-KELLY 24 cm, 9 ½" 76 x 38 mm	
3059	160	HMI-GS-3053	SIMS Small	
3060	160	HMI-GS-3054	SIMS Medium	
3061	160	HMI-GS-3055	SIMS Large	

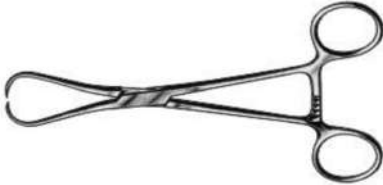




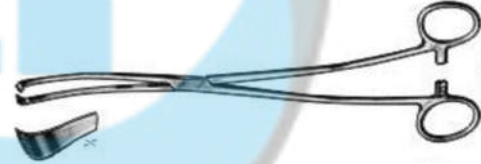



3062	161	HMI-GS-3056	AUVARD 65 x 38 mm - 28 mm 1,530 kg with fixed weight	
3063	161	HMI-GS-3057	AUVARD 75 x 42 mm (40 mm) with detachable weight 23 cm, 9"	
3064	161	HMI-GS-3058	AUVARD 105 x 43 mm (40 mm) with detachable weight 23 cm, 9"	
3065	161	HMI-GS-3059	AUVARD 2 1/2" Lbs	
3066	161	HMI-GS-3060	AUVARD 3 Lbs	
3067	161	HMI-GS-3061	SCHERBACK Set consisting of: 80 x 30 mm	 <p>14-250 80 x 30 mm</p> <p>14-251 65 x 30 mm</p> <p>14-252 85 x 33 mm</p> <p>14-253 75 x 35 mm</p> <p>14-254 100 x 38 mm</p> <p>14-255 85 x 35 mm</p>
3068	161	HMI-GS-3062	SCHERBACK Set consisting of: 65 x 30 mm	
3069	161	HMI-GS-3063	SCHERBACK Set consisting of: 85 x 33 mm	
3070	161	HMI-GS-3064	SCHERBACK Set consisting of: 75 x 35 mm	
3071	161	HMI-GS-3065	SCHERBACK Set consisting of: 100 x 38 mm	
3072	161	HMI-GS-3066	SCHERBACK Set consisting of: 85 x 35 mm	









3073	161	HMI-GS-3067	SCHERBACK Set consisting of: 110 x 42 mm	
3074	161	HMI-GS-3068	SCHERBACK Set consisting of: 95 x 35 mm	
3075	161	HMI-GS-3069	SCHERBACK Set consisting of: 2 handle 8 blades	
3076	161	HMI-GS-3070	BREISKY WIENER MODELL/ VIENNA PATTERN 30 cm, 12" 100 x 20 mm	
3077	161	HMI-GS-3071	BREISKY WIENER MODELL/ VIENNA PATTERN 30 cm, 12" 100 x 25 mm	
3078	161	HMI-GS-3072	BREISKY WIENER MODELL/ VIENNA PATTERN 30 cm, 12" 100 x 30 mm	
3079	161	HMI-GS-3073	BREISKY WIENER MODELL/ VIENNA PATTERN 30 cm, 12" 100 x 35 mm	
3080	161	HMI-GS-3074	BREISKY WIENER MODELL/ VIENNA PATTERN 30 cm, 12" 100 x 40 mm	
3081	161	HMI-GS-3075	LANDAU 30 cm, 12" 105 x 28 mm	


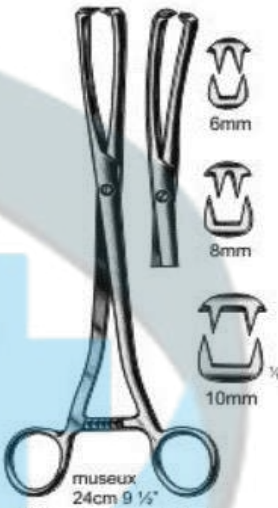
3082	161	HMI-GS-3076	LANDAU 30 cm, 12" 105 x 38 mm	
3083	161	HMI-GS-3077	FRIEDMANN 10 cm, 4"	
3084	162	HMI-GS-3078	PRATT GYNE Set of 8 Double ended size 13/14 thru 41/43 4.5/5.0mm thru 13.6/14.3mm	
3085	162	HMI-GS-3079	Set of 14 dilators (4.0 - 17.0 mm), in leather pouch with removable, washable canvas lining, with zip fastener	
3086	162	HMI-GS-3080	DILATORS SET Set of 5 dilators	
3087	162	HMI-GS-3081	Hank with conical point double ended Fig. 9/10 mmØ 4.5/5	
3088	162	HMI-GS-3082	Hank with conical point double ended Fig. 11/12 mmØ 5.56	
3089	162	HMI-GS-3083	Hank with conical point double ended Fig. 13/14 mmØ 6.5/7	







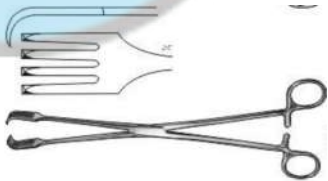
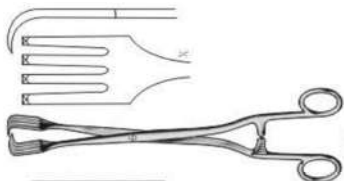
3090	162	HMI-GS-3084	Hank with conical point double ended Fig. 15/16 mmØ 7.5/8	
3091	162	HMI-GS-3085	Hank with conical point double ended Fig. 17/18 mmØ 8.5/9	
3092	162	HMI-GS-3086	Hank with conical point double ended Fig. 19/20 mmØ 9.5/10	
3093	163	HMI-GS-3087	WYLIE 29cm 11 ½" with graduated fixing screw, smooth jaws	
3094	163	HMI-GS-3088	WYLIE 29cm 11 ½" with graduated fixing screw, smooth jaws	
3095	163	HMI-GS-3089	SIMS 29cm 11 ½" with fixing screw, three-bladed, smooth jaws	
3096	163	HMI-GS-3090	GOODELL 29cm 11 ½" with graduated fixing screw, serrated jaws	
3097	163	HMI-GS-3091	SIMS UTERINE CURETTE double ended, sharp as above but blunt 25 cm, 10" small, medium, large	

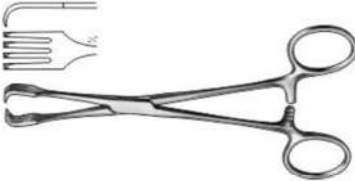
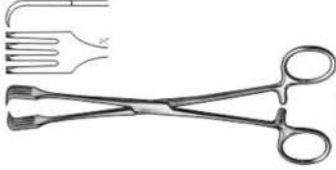



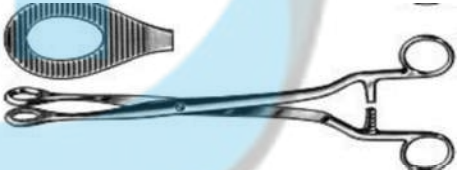


3098	163	HMI-GS-3092	SIMS schwed. Modell 26 cm, 10 1/4"	
3099	163	HMI-GS-3093	MARTIN 30 cm, 12"	
3100	163	HMI-GS-3094	VALLEIX 25 cm, 10"	
3101	163	HMI-GS-3095	GALABIN 32 cm, 12 1/4"	
3102	163	HMI-GS-3096	HORROCKS UTERINE SOUND 32 cm, 12 1/4"	
3103	163	HMI-GS-3097	NOVAK "SUCTION CANNULA CURETTE" Luer cone, 25.4 cm, 10"	
3104	164	HMI-GS-3098	SCHRÖDER 25 cm, 10"	
3105	164	HMI-GS-3099	SCHRÖDER 25cm 10"	







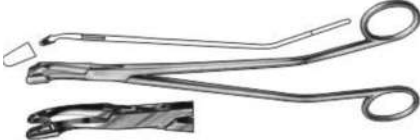
3106	164	HMI-GS-3100	STAUDE-MOORE 17cm 6 3/4"	
3107	164	HMI-GS-3101	SCHROEDER 25cm 10"	
3108	164	HMI-GS-3102	BRAUN 25cm 10"	
3109	164	HMI-GS-3103	POZZI 25cm 10"	
3110	164	HMI-GS-3104	BARRETT 18cm 7"	
3111	164	HMI-GS-3105	LOWA 26cm 10 1/4"	
3112	164	HMI-GS-3106	TEALE 23cm 9"	
3113	164	HMI-GS-3107	SCHRÖDER GYNE 24 cm, 9 1/2" straight	  <p>14-530 24 cm, 9 1/2" straight</p>









3114	164	HMI-GS-3108	SCHRÖDER GYNE 24 cm, 9 1/2" curved	
3115	165	HMI-GS-3109	DUPLAHY 28cm 11"	
3116	165	HMI-GS-3110	SKENE 24cm 9 1/2"	
3117	165	HMI-GS-3111	SCHROEDER 26cm 10 1/4"	
3118	165	HMI-GS-3112	SCHROEDER 26cm 10 1/4" Cvd. on flat	
3119	165	HMI-GS-3113	SCHROEDER 20cm 8" Cvd. on flat	
3120	165	HMI-GS-3114	SCHROEDER 24cm 9 1/2" Cvd. on flat	
3121	165	HMI-GS-3115	SCHROEDER 20cm 8" Cvd. on flat	









3122	165	HMI-GS-3116	SCHROEDER 24cm 9 1/2" Cvd. on flat	 14-572 20cm 8" 14-573 24cm 9 1/2" Cvd. on flat
3123	165	HMI-GS-3117	museux 24cm 9 1/2" Jaw Width mm 6 Str.	
3124	165	HMI-GS-3118	museux 24cm 9 1/2" Jaw Width mm 8 Str.	
3125	165	HMI-GS-3119	museux 24cm 9 1/2" Jaw Width mm 10 Str.	
3126	165	HMI-GS-3120	museux 24cm 9 1/2" Jaw Width mm 6 Cvd. Sideways	
3127	165	HMI-GS-3121	museux 24cm 9 1/2" Jaw Width mm 8 Cvd. sideways	
3128	165	HMI-GS-3122	museux 24cm 9 1/2" Jaw Width mm 10 Cvd. sideways	
3129	165	HMI-GS-3123	museux 26cm 10 1/2" Jaw Width mm 9 Str.	





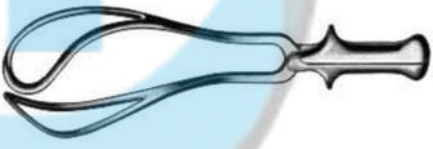


3130	165	HMI-GS-3124	museux 26cm 10 1/2" Jaw Width mm 11 Str.	
3131	165	HMI-GS-3125	museux 26cm 10 1/2" Jaw Width mm 13 Str.	
3132	165	HMI-GS-3126	museux 26cm 10 1/2" Jaw Width mm 9 Cvd. sideways	
3133	165	HMI-GS-3127	museux 26cm 10 1/2" Jaw Width mm 11 Cvd. sideways	
3134	165	HMI-GS-3128	museux 26cm 10 1/2" Jaw Width mm 13 Cvd. sideways	
3135	165	HMI-GS-3129	Henrotin 20.5cm 8"	
3136	165	HMI-GS-3130	26cm 10 1/4"	
3137	165	HMI-GS-3131	Pratt 28cm 11"	








3138	166	HMI-GS-3132	BRAUN 15.5cm 6 1/4"	
3139	166	HMI-GS-3133	CZERNY 20.5cm 8 1/4"	
3140	166	HMI-GS-3134	PRUESMANN 27.5cm 10 3/4"	
3141	166	HMI-GS-3135	COLLIN 25cm 10"	
3142	166	HMI-GS-3136	KELLY 32cm 12 1/2"	
3143	166	HMI-GS-3137	NOTO 27cm 10 1/2"	
3144	166	HMI-GS-3138	DARTIGUES 27cm 10 1/2"	
3145	166	HMI-GS-3139	SOMER 23cm 9"	



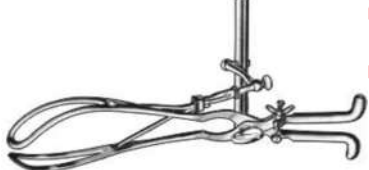


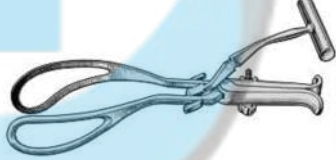

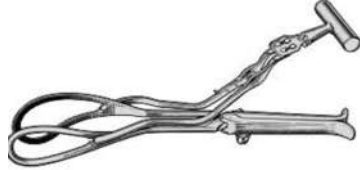
3146	166	HMI-GS-3140	GELLHORN 23cm 9"	
3147	166	HMI-GS-3141	FAURE 21cm 8 1/4"	
3148	167	HMI-GS-3142	SCHUBERT 21cm 8 1/4"	
3149	167	HMI-GS-3143	SCHUBERT 29cm 11 1/2"	
3150	167	HMI-GS-3144	THOMS-GAYLOR 24cm 9 1/2"	
3151	167	HMI-GS-3145	GELLHORN Biopsy Punch Forceps 24cm 9 1/2"	
3152	167	HMI-GS-3146	SCHUBERT 26cm 10 1/4"	
3153	167	HMI-GS-3147	VAN DOREN 25cm 10"	




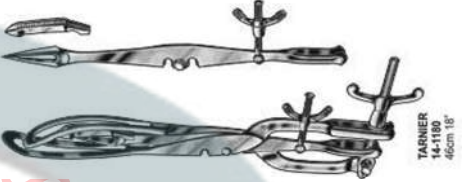




3154	167	HMI-GS-3148	ALEXANDER 28cm 11"	
3155	167	HMI-GS-3149	SCHUMACHER Forcep with exchangeable tip	
3156	168	HMI-GS-3150	BLAKE 27 cm, 10 3/4"	
3157	168	HMI-GS-3151	ZWEIFEL 31 cm	
3158	168	HMI-GS-3152	SIMS 31cm 12 1/2" malleable	
3159	168	HMI-GS-3153	RECAMIER 26cm malleable	
3160	168	HMI-GS-3154	RECAMIER 31cm malleable	
3161	169	HMI-GS-3155	SIMS 25cm	








3162	169	HMI-GS-3156	THOMAS 28cm	
3163	169	HMI-GS-3157	COLLIN 28cm 11" Uterine sound with slide & adjustable shaft	
3164	169	HMI-GS-3158	VALLEIX 25cm 10" ditto, with slide	
3165	169	HMI-GS-3159	RANDALL 24cm 9 1/2"	
3166	169	HMI-GS-3160	NOVAK 23cm 9" 4mm	
3167	169	HMI-GS-3161	SEGOND	
3168	169	HMI-GS-3162	DOYEN 17cm 6 3/4"	
3169	170	HMI-GS-3163	KIELLAND 41 cm, 16"	

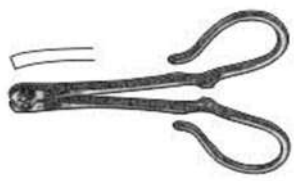
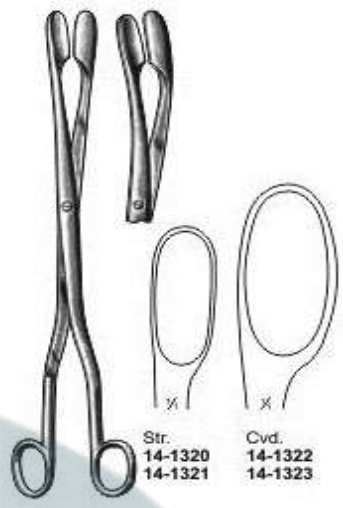



3170	170	HMI-GS-3164	SIMPSON 30 cm, 12"	
3171	170	HMI-GS-3165	SIMPSON-BRAUN 33 cm, 13 1/2"	
3172	170	HMI-GS-3166	SIMPSON-BRAUN 38 cm, 14 1/2"	
3173	170	HMI-GS-3167	DE LEE 30 cm, 12"	
3174	170	HMI-GS-3168	WRIGLEY 23 cm, 9"	
3175	170	HMI-GS-3169	DE LEE 30cm 12"	
3176	170	HMI-GS-3170	DE LEE 36cm 14"	
3177	170	HMI-GS-3171	ELLIOT 32cm	

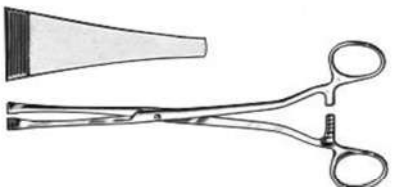




3178	170	HMI-GS-3172	ELLIOT 38cm	
3179	170	HMI-GS-3173	KIELLAND-LUIKART 41 cm, 16"	
3180	170	HMI-GS-3174	NAEGELE 36 cm, 14 1/4"	
3181	170	HMI-GS-3175	NAEGELE 40 cm, 15 3/4"	
3182	170	HMI-GS-3176	PIPER 44 cm, 18"	
3183	171	HMI-GS-3177	MCLEAN 36 cm, 14 1/4"	
3184	171	HMI-GS-3178	SIMPSON-LUIKART 36cm 14"	
3185	171	HMI-GS-3179	Mc LEAN-TUCKER 39cm 15"	

3186	171	HMI-GS-3180	KEDARNATH DAS 33cm	
3187	171	HMI-GS-3181	BOERMA 29cm	
3188	171	HMI-GS-3182	TARNIER 40cm 15 3/4" with traction handle	
3189	171	HMI-GS-3183	DEWEY 37cm 14 1/2" with traction handle	
3190	171	HMI-GS-3184	PIPER 40cm 15 3/4" with traction handle	
3191	171	HMI-GS-3185	HAIG FERGUSON detachable axis traction rod & handle.	
3192	172	HMI-GS-3186	BARNES-NEVILLE Simpson handles, detachable axis traction rod and handle.	
3193	172	HMI-GS-3187	MILNE MURRAY detachable axis traction rod & handle.	

3194	172	HMI-GS-3188	BRAUN 42 cm, 16 ¼"	
3195	172	HMI-GS-3189	TARNIER 44 cm, 17 ¼"	
3196	172	HMI-GS-3190	LUIKART 40cm 15 3/4"	
3197	172	HMI-GS-3191	TARNIER 46cm 18"	
3198	172	HMI-GS-3192	BRAUN 42cm 16 ½"	
3199	173	HMI-GS-3193	NAEGELE 25 cm, 10"	
3200	173	HMI-GS-3194	SMELLIE 25 cm, 10"	
3201	173	HMI-GS-3195	BRAUN 30 cm, 12"	

3202	173	HMI-GS-3196	SMELLIE 30 cm, 12"	
3203	173	HMI-GS-3197	TARGET 26cm	
3204	173	HMI-GS-3198	TARGET 30cm	
3205	173	HMI-GS-3199	M-PELVIMETER 34cm 13 1/2" cm scale	
3206	173	HMI-GS-3200	M-PELVIMETER 34cm 13 1/2" in/cm scale	
3207	173	HMI-GS-3201	COLLIN 35cm 13 3/4" cm scale	
3208	173	HMI-GS-3202	COLLYER 30cm 12" cm/Inch scale	
3209	173	HMI-GS-3203	BREISKY 33cm 13" cm/Inch scale	

3210	174	HMI-GS-3204	KANE 8.5cm	
3211	174	HMI-GS-3205	WINTER 28cm 11" Str.	
3212	174	HMI-GS-3206	WINTER 28cm 11" Str.	
3213	174	HMI-GS-3207	WINTER 28cm 11" Cvd.	
3214	174	HMI-GS-3208	WINTER 28cm 11" Cvd.	
3215	174	HMI-GS-3209	HEYWOOD-SMITH 25.5cm	
3216	174	HMI-GS-3210	COREY (GREENHALG) 24cm 9 1/2"	
3217	174	HMI-GS-3211	SAENGER 27cm 10 1/2"	

3218	174	HMI-GS-3212	GREEN-ARMYTAGE 21cm 8 1/4" Str. & Cvd.	
3219	174	HMI-GS-3213	WILLETT Scalpel Flap Forceps 18.5 cm, 7 1/4"	
3220	174	HMI-GS-3214	GAUSS Scalpel Flap Forceps 26 cm, 10 1/4"	
3221	174	HMI-GS-3215	MURLESS 26cm 10 1/4"	
3222	174	HMI-GS-3216	SELLHEIM 28cm 11"	
3223	HOLLOW WARE			
3224				
3225	175	HMI-GS-3217	STERILIZING DRUMS, 80 mm	
3226	175	HMI-GS-3218	STERILIZING DRUMS, 120 mm	
3227	175	HMI-GS-3219	STERILIZING DRUMS, 160 mm	
3228	175	HMI-GS-3220	STERILIZING DRUMS, 190 mm	
3229	175	HMI-GS-3221	STERILIZING DRUMS, 190 mm	

3230	175	HMI-GS-3222	STERILIZING DRUMS, 240 mm
3231	175	HMI-GS-3223	STERILIZING DRUMS, 240 mm
3232	175	HMI-GS-3224	STERILIZING DRUMS, 240 mm
3233	175	HMI-GS-3225	STERILIZING DRUMS, 290 mm
3234	175	HMI-GS-3226	STERILIZING DRUMS, 290 mm
3235	175	HMI-GS-3227	STERILIZING DRUMS, 290 mm
3236	175	HMI-GS-3228	STERILIZING DRUMS, 340 mm
3237	175	HMI-GS-3229	STERILIZING DRUMS, 340 mm
3238	175	HMI-GS-3230	STERILIZING DRUMS, 390 mm
3239	175	HMI-GS-3231	STERILIZING DRUMS, 390 mm
3240	175	HMI-GS-3232	STERILIZING DRUMS, 390 mm
3241	175	HMI-GS-3233	STERILIZING DRUM, 150 x 150 mm
3242	175	HMI-GS-3234	STERILIZING DRUM, 175 x 175 mm
3243	175	HMI-GS-3235	STERILIZING DRUM, 190 x 190 mm
3244	175	HMI-GS-3236	STERILIZING DRUM, 200 x 140 mm
3245	175	HMI-GS-3237	STERILIZING DRUM, 200 x 200 mm



3246	175	HMI-GS-3238	STERILIZING DRUM, 240 x 120 mm
3247	175	HMI-GS-3239	STERILIZING DRUM, 225 x 225 mm
3248	175	HMI-GS-3240	STERILIZING DRUM, 240 x 240 mm
3249	175	HMI-GS-3241	STERILIZING DRUM, 290 x 160 mm
3250	175	HMI-GS-3242	STERILIZING DRUM, 280 x 240 mm
3251	175	HMI-GS-3243	STERILIZING DRUM, 230 x 150 mm
3252	175	HMI-GS-3244	STERILIZING DRUM, 300 x 250 mm
3253	175	HMI-GS-3245	STERILIZING DRUM, 340 x 250 mm
3254	175	HMI-GS-3246	STERILIZING DRUM, 350 x 250 mm
3255	175	HMI-GS-3247	STERILIZING DRUM, 390 x 200 mm
3256	175	HMI-GS-3248	STERILIZING DRUM, 150 x 150 mm
3257	175	HMI-GS-3249	STERILIZING DRUM, 175 x 175 mm
3258	175	HMI-GS-3250	STERILIZING DRUM, 190 x 190 mm
3259	175	HMI-GS-3251	STERILIZING DRUM, 200 x 140 mm
3260	175	HMI-GS-3252	STERILIZING DRUM, 200 x 200 mm
3261	175	HMI-GS-3253	STERILIZING DRUM, 240 x 120 mm



3262	175	HMI-GS-3254	STERILIZING DRUM, 225 x 225 mm
3263	175	HMI-GS-3255	STERILIZING DRUM, 240 x 240 mm
3264	175	HMI-GS-3256	STERILIZING DRUM, 290 x 160 mm
3265	175	HMI-GS-3257	STERILIZING DRUM, 280 x 240 mm
3266	175	HMI-GS-3258	STERILIZING DRUM, 230 x 150 mm
3267	175	HMI-GS-3259	STERILIZING DRUM, 300 x 250 mm
3268	175	HMI-GS-3260	STERILIZING DRUM, 340 x 250 mm
3269	175	HMI-GS-3261	STERILIZING DRUM, 350 x 250 mm
3270	175	HMI-GS-3262	STERILIZING DRUM, 390 x 200 mm
3271	175	HMI-GS-3263	STERILIZING DRUM, 150 x 150 mm
3272	175	HMI-GS-3264	STERILIZING DRUM, 175 x 175 mm
3273	175	HMI-GS-3265	STERILIZING DRUM, 190 x 190 mm
3274	175	HMI-GS-3266	STERILIZING DRUM, 200 x 140 mm
3275	175	HMI-GS-3267	STERILIZING DRUM, 200 x 200 mm
3276	175	HMI-GS-3268	STERILIZING DRUM, 240 x 120 mm
3277	175	HMI-GS-3269	STERILIZING DRUM, 225 x 225 mm

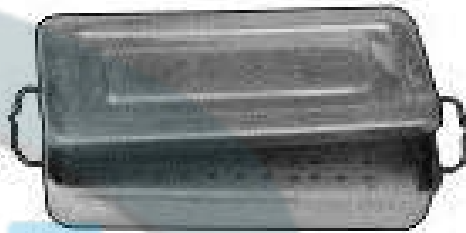


3278	175	HMI-GS-3270	STERILIZING DRUM, 240 x 240 mm
3279	175	HMI-GS-3271	STERILIZING DRUM, 290 x 160 mm
3280	175	HMI-GS-3272	STERILIZING DRUM, 280 x 240 mm
3281	175	HMI-GS-3273	STERILIZING DRUM, 230 x 150 mm
3282	175	HMI-GS-3274	STERILIZING DRUM, 300 x 250 mm
3283	175	HMI-GS-3275	STERILIZING DRUM, 340 x 250 mm
3284	175	HMI-GS-3276	STERILIZING DRUM, 350 x 250 mm
3285	175	HMI-GS-3277	STERILIZING DRUM, 390 x 200 mm
3286	175	HMI-GS-3278	STERILIZING DRUM, 150 x 150 mm
3287	175	HMI-GS-3279	STERILIZING DRUM, 175 x 175 mm
3288	175	HMI-GS-3280	STERILIZING DRUM, 190 x 190 mm
3289	175	HMI-GS-3281	STERILIZING DRUM, 200 x 140 mm
3290	175	HMI-GS-3282	STERILIZING DRUM, 200 x 200 mm
3291	175	HMI-GS-3283	STERILIZING DRUM, 240 x 120 mm
3292	175	HMI-GS-3284	STERILIZING DRUM, 225 x 225 mm
3293	175	HMI-GS-3285	STERILIZING DRUM, 240 x 240 mm



3294	175	HMI-GS-3286	STERILIZING DRUM, 290 x 160 mm	
3295	175	HMI-GS-3287	STERILIZING DRUM, 280 x 240 mm	
3296	175	HMI-GS-3288	STERILIZING DRUM, 230 x 150 mm	
3297	175	HMI-GS-3289	STERILIZING DRUM, 300 x 250 mm	
3298	175	HMI-GS-3290	STERILIZING DRUM, 340 x 250 mm	
3299	175	HMI-GS-3291	STERILIZING DRUM, 350 x 250 mm	
3300	175	HMI-GS-3292	STERILIZING DRUM, 390 x 200 mm	
3301	176	HMI-GS-3293	G LOVES BOX 300 x 150 mm	
3302	176	HMI-GS-3294	INSTRUMENT TRAY WITH COVER	
3303	176	HMI-GS-3295	INSTRUMENT TRAY	
3304	176	HMI-GS-3296	CATHER TRAY, 230 x 75 mm	
3305	176	HMI-GS-3297	CATHER TRAY, 350 x 90 mm	
3306	176	HMI-GS-3298	CATHER TRAY, 430 x 100 mm	

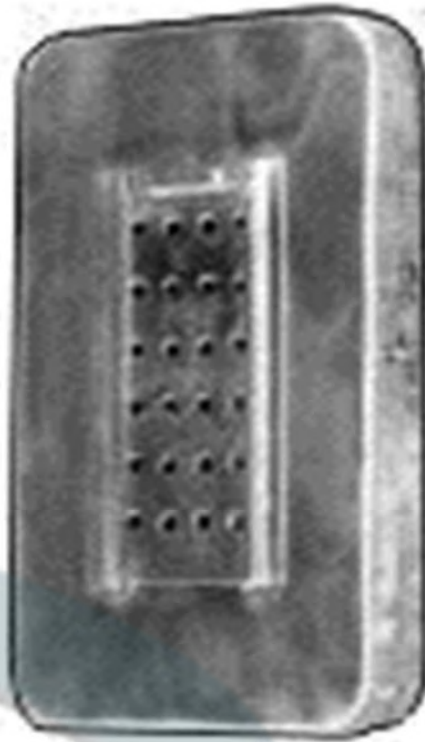
3307	176	HMI-GS-3299	CATHER TRAY, 200 x 100 mm
3308	176	HMI-GS-3300	CATHER TRAY, 300 x 100 mm
3309	176	HMI-GS-3301	CATHER TRAY, 350 x 100 mm
3310	176	HMI-GS-3302	INSTRUMENT BOILER, 180 x 80 x 40 mm
3311	176	HMI-GS-3303	INSTRUMENT BOILER, 200 x 100 x 50 mm
3312	176	HMI-GS-3304	INSTRUMENT BOILER, 250 x 125 x 40 mm
3313	176	HMI-GS-3305	INSTRUMENT BOILER, 300 x 150 x 60 mm
3314	176	HMI-GS-3306	INSTRUMENT BOILER, 350 x 175 x 75 mm
3315	176	HMI-GS-3307	INSTRUMENT BOILER, 400 x 200 x 100 mm
3316	176	HMI-GS-3308	PERFORATED TRAY, 180 x 80 x 40 mm
3317	176	HMI-GS-3309	PERFORATED TRAY, 200 x 100 x 50 mm
3318	176	HMI-GS-3310	PERFORATED TRAY, 250 x 125 x 40 mm
3319	176	HMI-GS-3311	PERFORATED TRAY, 300 x 150 x 60 mm
3320	176	HMI-GS-3312	PERFORATED TRAY, 350 x 175 x 75 mm
3321	176	HMI-GS-3313	PERFORATED TRAY, 400 x 200 x 100 mm
3322	176	HMI-GS-3314	INSTRUMENT BOILER WITH STAND, 180 x 80 x 40 mm



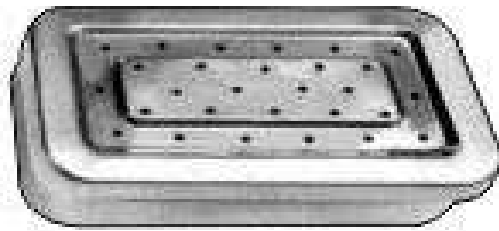
3323	176	HMI-GS-3315	INSTRUMENT BOILER WITH STAND, 200 x 100 x 50 mm
3324	176	HMI-GS-3316	INSTRUMENT BOILER WITH STAND, 250 x 125 x 40 mm
3325	176	HMI-GS-3317	INSTRUMENT BOILER WITH STAND, 300 x 150 x 60 mm
3326	176	HMI-GS-3318	INSTRUMENT BOILER WITH STAND, 350 x 175 x 75 mm
3327	176	HMI-GS-3319	INSTRUMENT BOILER WITH STAND, 400 x 200 x 100 mm
3328	176	HMI-GS-3320	INSTRUMENT BOILER ELECTRIC, 180 x 80 x 40 mm
3329	176	HMI-GS-3321	INSTRUMENT BOILER ELECTRIC, 200 x 100 x 50 mm
3330	176	HMI-GS-3322	INSTRUMENT BOILER ELECTRIC, 250 x 125 x 40 mm
3331	176	HMI-GS-3323	INSTRUMENT BOILER ELECTRIC, 300 x 150 x 60 mm
3332	176	HMI-GS-3324	INSTRUMENT BOILER ELECTRIC, 350 x 175 x 75 mm
3333	176	HMI-GS-3325	INSTRUMENT BOILER ELECTRIC, 400 x 200 x 100 mm
3334	176	HMI-GS-3326	PERFORATED BOX, 100 x 50 mm
3335	176	HMI-GS-3327	PERFORATED BOX, 165 x 65 mm
3336	176	HMI-GS-3328	PERFORATED BOX, 250 x 100 mm
3337	176	HMI-GS-3329	PERFORATED BOX, 250 x 150 mm
3338	176	HMI-GS-3330	PERFORATED BOX, 250 x 200 mm



3339	176	HMI-GS-3331	PERFORATED BOX, 150 x 65 mm
3340	176	HMI-GS-3332	PERFORATED BOX, 170 x 70 mm
3341	176	HMI-GS-3333	PERFORATED BOX, 200 x 100 mm
3342	176	HMI-GS-3334	PERFORATED BOX, 250 x 125 mm
3343	176	HMI-GS-3335	PERFORATED BOX, 300 x 150 mm
3344	176	HMI-GS-3336	PERFORATED BOX, 300 x 200 mm
3345	176	HMI-GS-3337	PERFORATED BOX, 300 x 130 mm
3346	176	HMI-GS-3338	PERFORATED BOX, 320 x 150 mm
3347	176	HMI-GS-3339	PERFORATED BOX, 420 x 180 mm
3348	176	HMI-GS-3340	PERFORATED BOX, 460 x 125 mm
3349	176	HMI-GS-3341	PERFORATED BOX, 355 x 180 mm
3350	176	HMI-GS-3342	PERFORATED BOX, 300 x 180 mm
3351	176	HMI-GS-3343	PERFORATED BOX, 400 x 200 mm
3352	176	HMI-GS-3344	PERFORATED BOX, 510 x 200 mm
3353	176	HMI-GS-3345	BOX WITH FILTER, 100 x 50 mm
3354	176	HMI-GS-3346	BOX WITH FILTER, 165 x 65 mm

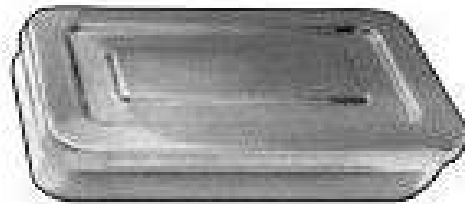


3355	176	HMI-GS-3347	BOX WITH FILTER, 250 x 100 mm
3356	176	HMI-GS-3348	BOX WITH FILTER, 250 x 150 mm
3357	176	HMI-GS-3349	BOX WITH FILTER, 250 x 200 mm
3358	176	HMI-GS-3350	BOX WITH FILTER, 150 x 65 mm
3359	176	HMI-GS-3351	BOX WITH FILTER, 170 x 70 mm
3360	176	HMI-GS-3352	BOX WITH FILTER, 200 x 100 mm
3361	176	HMI-GS-3353	BOX WITH FILTER, 250 x 125 mm
3362	176	HMI-GS-3354	BOX WITH FILTER, 300 x 150 mm
3363	176	HMI-GS-3355	BOX WITH FILTER, 300 x 200 mm
3364	176	HMI-GS-3356	BOX WITH FILTER, 300 x 130 mm
3365	176	HMI-GS-3357	BOX WITH FILTER, 320 x 150 mm
3366	176	HMI-GS-3358	BOX WITH FILTER, 420 x 180 mm
3367	176	HMI-GS-3359	BOX WITH FILTER, 460 x 125 mm
3368	176	HMI-GS-3360	BOX WITH FILTER, 355 x 180 mm
3369	176	HMI-GS-3361	BOX WITH FILTER, 300 x 180 mm
3370	176	HMI-GS-3362	BOX WITH FILTER, 400 x 200 mm

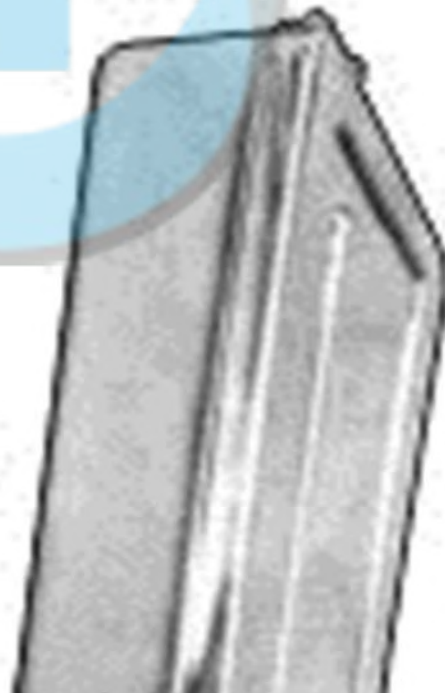


MEDICAL INSTRUMENTS

3371	176	HMI-GS-3363	BOX WITH FILTER, 510 x 200 mm
3372	176	HMI-GS-3364	INSTRUMENTS BOX Without Clip, 100 x 50 mm
3373	176	HMI-GS-3365	INSTRUMENTS BOX Without Clip, 165 x 65 mm
3374	176	HMI-GS-3366	INSTRUMENTS BOX Without Clip, 250 x 100 mm
3375	176	HMI-GS-3367	INSTRUMENTS BOX Without Clip, 250 x 150 mm
3376	176	HMI-GS-3368	INSTRUMENTS BOX Without Clip, 250 x 200 mm
3377	176	HMI-GS-3369	INSTRUMENTS BOX Without Clip, 150 x 65 mm
3378	176	HMI-GS-3370	INSTRUMENTS BOX Without Clip, 170 x 70 mm
3379	176	HMI-GS-3371	INSTRUMENTS BOX Without Clip, 200 x 100 mm
3380	176	HMI-GS-3372	INSTRUMENTS BOX Without Clip, 250 x 125 mm
3381	176	HMI-GS-3373	INSTRUMENTS BOX Without Clip, 300 x 150 mm
3382	176	HMI-GS-3374	INSTRUMENTS BOX Without Clip, 300 x 200 mm
3383	176	HMI-GS-3375	INSTRUMENTS BOX Without Clip, 300 x 130 mm
3384	176	HMI-GS-3376	INSTRUMENTS BOX Without Clip, 320 x 150 mm
3385	176	HMI-GS-3377	INSTRUMENTS BOX Without Clip, 420 x 180 mm
3386	176	HMI-GS-3378	INSTRUMENTS BOX Without Clip, 460 x 125 mm





3387	176	HMI-GS-3379	INSTRUMENTS BOX Without Clip, 355 x 180 mm
3388	176	HMI-GS-3380	INSTRUMENTS BOX Without Clip, 300 x 180 mm
3389	176	HMI-GS-3381	INSTRUMENTS BOX Without Clip, 400 x 200 mm
3390	176	HMI-GS-3382	INSTRUMENTS BOX Without Clip, 510 x 200 mm
3391	176	HMI-GS-3383	INSTRUMENT BOX With Clip, 100 x 50 mm
3392	176	HMI-GS-3384	INSTRUMENT BOX With Clip, 165 x 65 mm
3393	176	HMI-GS-3385	INSTRUMENT BOX With Clip, 250 x 100 mm
3394	176	HMI-GS-3386	INSTRUMENT BOX With Clip, 250 x 150 mm
3395	176	HMI-GS-3387	INSTRUMENT BOX With Clip, 250 x 200 mm
3396	176	HMI-GS-3388	INSTRUMENT BOX With Clip, 150 x 65 mm
3397	176	HMI-GS-3389	INSTRUMENT BOX With Clip, 170 x 70 mm
3398	176	HMI-GS-3390	INSTRUMENT BOX With Clip, 200 x 100 mm
3399	176	HMI-GS-3391	INSTRUMENT BOX With Clip, 250 x 125 mm
3400	176	HMI-GS-3392	INSTRUMENT BOX With Clip, 300 x 150 mm
3401	176	HMI-GS-3393	INSTRUMENT BOX With Clip, 300 x 200 mm
3402	176	HMI-GS-3394	INSTRUMENT BOX With Clip, 300 x 130 mm



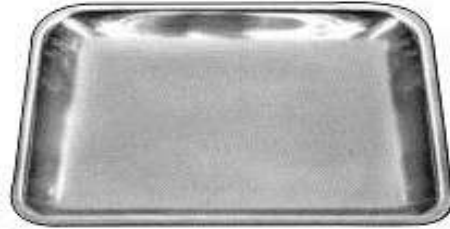
UNAPPROVED INSTRUMENTS

3403	176	HMI-GS-3395	INSTRUMENT BOX With Clip, 320 x 150 mm		
3404	176	HMI-GS-3396	INSTRUMENT BOX With Clip, 420 x 180 mm		
3405	176	HMI-GS-3397	INSTRUMENT BOX With Clip, 460 x 125 mm		
3406	176	HMI-GS-3398	INSTRUMENT BOX With Clip, 355 x 180 mm		
3407	176	HMI-GS-3399	INSTRUMENT BOX With Clip, 300 x 180 mm		
3408	176	HMI-GS-3400	INSTRUMENT BOX With Clip, 400 x 200 mm		
3409	176	HMI-GS-3401	INSTRUMENT BOX With Clip, 510 x 200 mm		
3410	177	HMI-GS-3402	NEEDLE CASE 230 x 125 mm		
3411	177	HMI-GS-3403	SCALER BOX 300 x 180 mm		
3412	177	HMI-GS-3404	SCALER TRAY 100 x 200 mm		
3413	177	HMI-GS-3405	Autoclaveable		

3414	177	HMI-GS-3406	INDO BOX WITH SILVER FRAME	
3415	177	HMI-GS-3407	INSTRUMENT TRAY WITHOUT COVER, 240 x 240 mm	
3416	177	HMI-GS-3408	INSTRUMENT TRAY WITHOUT COVER, 355 x 400 mm	
3417	177	HMI-GS-3409	INSTRUMENT TRAY WITHOUT COVER, 300 x 150 mm	
3418	177	HMI-GS-3410	INSTRUMENT TRAY WITHOUT COVER, 300 x 180 mm	
3419	177	HMI-GS-3411	INSTRUMENT TRAY WITHOUT COVER, 300 x 240 mm	
3420	177	HMI-GS-3412	INSTRUMENT TRAY WITHOUT COVER, 340 x 320 mm	
3421	177	HMI-GS-3413	INSTRUMENT TRAY WITHOUT COVER, 230 x 180 mm	
3422	177	HMI-GS-3414	INSTRUMENT TRAY WITHOUT COVER, 250 x 130 mm	
3423	177	HMI-GS-3415	INSTRUMENT TRAY WITHOUT COVER, 200 x 130 mm	
3424	177	HMI-GS-3416	INSTRUMENT TRAY WITHOUT COVER, 180 x 130 mm	
3425	177	HMI-GS-3417	INSTRUMENT TRAY WITHOUT COVER, 150 x 100 mm	
3426	177	HMI-GS-3418	INSTRUMENT TRAY WITHOUT COVER, 230 x 125 mm	
3427	177	HMI-GS-3419	INSTRUMENT TRAY WITHOUT COVER, 200 x 150 mm	
3428	177	HMI-GS-3420	INSTRUMENT TRAY WITHOUT COVER, 250 x 200 mm	

3429	177	HMI-GS-3421	INSTRUMENT TRAY WITHOUT COVER, 300 x 250 mm
3430	177	HMI-GS-3422	INSTRUMENT TRAY WITHOUT COVER, 350 x 300 mm
3431	177	HMI-GS-3423	INSTRUMENT TRAY WITHOUT COVER, 400 x 350 mm
3432	177	HMI-GS-3424	INSTRUMENT TRAY WITHOUT COVER, 450 x 300 mm
3433	177	HMI-GS-3425	INSTRUMENT TRAY WITHOUT COVER, 300 x 200 mm
3434	177	HMI-GS-3426	INSTRUMENT TRAY WITHOUT COVER, 350 x 250 mm
3435	177	HMI-GS-3427	INSTRUMENT TRAY WITHOUT COVER, 250 x 125 mm
3436	177	HMI-GS-3428	INSTRUMENT TRAY WITHOUT COVER, 200 x 100 mm
3437	177	HMI-GS-3429	INSTRUMENT TRAY WITHOUT COVER, 400 x 200 mm
3438	177	HMI-GS-3430	INSTRUMENT TRAY WITHOUT COVER, 240 x 240 mm
3439	177	HMI-GS-3431	INSTRUMENT TRAY WITHOUT COVER, 355 x 400 mm
3440	177	HMI-GS-3432	INSTRUMENT TRAY WITHOUT COVER, 300 x 150 mm
3441	177	HMI-GS-3433	INSTRUMENT TRAY WITHOUT COVER, 300 x 180 mm
3442	177	HMI-GS-3434	INSTRUMENT TRAY WITHOUT COVER, 300 x 240 mm
3443	177	HMI-GS-3435	INSTRUMENT TRAY WITHOUT COVER, 340 x 320 mm
3444	177	HMI-GS-3436	INSTRUMENT TRAY WITHOUT COVER, 230 x 180 mm

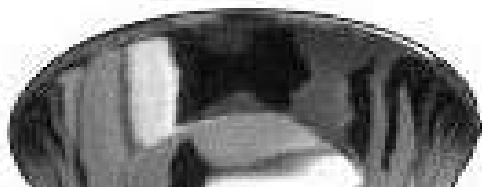
3445	177	HMI-GS-3437	INSTRUMENT TRAY WITHOUT COVER, 250 x 130 mm
3446	177	HMI-GS-3438	INSTRUMENT TRAY WITHOUT COVER, 200 x 130 mm
3447	177	HMI-GS-3439	INSTRUMENT TRAY WITHOUT COVER, 180 x 130 mm
3448	177	HMI-GS-3440	INSTRUMENT TRAY WITHOUT COVER, 150 x 100 mm
3449	177	HMI-GS-3441	INSTRUMENT TRAY WITHOUT COVER, 230 x 125 mm
3450	177	HMI-GS-3442	INSTRUMENT TRAY WITHOUT COVER, 200 x 150 mm
3451	177	HMI-GS-3443	INSTRUMENT TRAY WITHOUT COVER, 250 x 200 mm
3452	177	HMI-GS-3444	INSTRUMENT TRAY WITHOUT COVER, 300 x 250 mm
3453	177	HMI-GS-3445	INSTRUMENT TRAY WITHOUT COVER, 350 x 300 mm
3454	177	HMI-GS-3446	INSTRUMENT TRAY WITHOUT COVER, 400 x 350 mm
3455	177	HMI-GS-3447	INSTRUMENT TRAY WITHOUT COVER, 450 x 300 mm
3456	177	HMI-GS-3448	INSTRUMENT TRAY WITHOUT COVER, 300 x 200 mm
3457	177	HMI-GS-3449	INSTRUMENT TRAY WITHOUT COVER, 350 x 250 mm
3458	177	HMI-GS-3450	INSTRUMENT TRAY WITHOUT COVER, 250 x 125 mm
3459	177	HMI-GS-3451	INSTRUMENT TRAY WITHOUT COVER, 200 x 100 mm
3460	177	HMI-GS-3452	INSTRUMENT TRAY WITHOUT COVER, 400 x 200 mm



STERILIZED INSTRUMENTS

3461	178	HMI-GS-3453	KIDNEY TRAY WITH COVER (English Pattern), 150 mm	
3462	178	HMI-GS-3454	KIDNEY TRAY WITH COVER (English Pattern), 200 mm	
3463	178	HMI-GS-3455	KIDNEY TRAY WITH COVER (English Pattern), 240 mm	
3464	178	HMI-GS-3456	KIDNEY TRAY WITH COVER (English Pattern), 300 mm	
3465	178	HMI-GS-3457	KIDNEY TRAY (German Pattern) (without cover), 150 mm	
3466	178	HMI-GS-3458	KIDNEY TRAY (German Pattern) (without cover), 200 mm	
3467	178	HMI-GS-3459	KIDNEY TRAY (German Pattern) (without cover), 240 mm	
3468	178	HMI-GS-3460	KIDNEY TRAY (German Pattern) (without cover), 300 mm	
3469	178	HMI-GS-3461	SPLIT LAMP 100 ml.	
3470	178	HMI-GS-3462	BOWL, 80 mm	
3471	178	HMI-GS-3463	BOWL, 100 mm	
3472	178	HMI-GS-3464	BOWL, 125 mm	
3473	178	HMI-GS-3465	BOWL, 150 mm	
3474	178	HMI-GS-3466	BOWL, 200 mm	
3475	178	HMI-GS-3467	BOWL, 250 mm	

3476	178	HMI-GS-3468	BOWL, 300 mm
3477	178	HMI-GS-3469	BOWL, 350 mm
3478	178	HMI-GS-3470	BOWL, 400 mm
3479	178	HMI-GS-3471	WASH BASIN 80 mm
3480	178	HMI-GS-3472	WASH BASIN 100 mm
3481	178	HMI-GS-3473	WASH BASIN 125 mm
3482	178	HMI-GS-3474	WASH BASIN 150 mm
3483	178	HMI-GS-3475	WASH BASIN 200 mm
3484	178	HMI-GS-3476	WASH BASIN 250 mm
3485	178	HMI-GS-3477	WASH BASIN 300 mm
3486	178	HMI-GS-3478	WASH BASIN 350 mm
3487	178	HMI-GS-3479	WASH BASIN 400 mm
3488	178	HMI-GS-3480	BOWL 80 mm
3489	178	HMI-GS-3481	BOWL 100 mm
3490	178	HMI-GS-3482	BOWL 125 mm
3491	178	HMI-GS-3483	BOWL 150 mm



3492	178	HMI-GS-3484	BOWL 200 mm
3493	178	HMI-GS-3485	BOWL 250 mm
3494	178	HMI-GS-3486	BOWL 300 mm
3495	178	HMI-GS-3487	BOWL 350 mm
3496	178	HMI-GS-3488	BOWL 400 mm
3497	178	HMI-GS-3489	DRESSING JAR WITH KNOB, 80 x 80 mm
3498	178	HMI-GS-3490	DRESSING JAR WITH KNOB, 100 x 100 mm
3499	178	HMI-GS-3491	DRESSING JAR WITH KNOB, 125 x 125 mm
3500	178	HMI-GS-3492	DRESSING JAR WITH KNOB, 150 x 150 mm
3501	178	HMI-GS-3493	DRESSING JAR WITH KNOB, 200 x 200 mm
3502	178	HMI-GS-3494	DRESSING JAR, 80 x 80 mm
3503	178	HMI-GS-3495	DRESSING JAR, 100 x 100 mm
3504	178	HMI-GS-3496	DRESSING JAR, 125 x 125 mm
3505	178	HMI-GS-3497	DRESSING JAR, 150 x 150 mm
3506	178	HMI-GS-3498	DRESSING JAR, 200 x 200 mm
3507	178	HMI-GS-3499	DRESSING JAR, 80 x 80 mm



3508	178	HMI-GS-3500	DRESSING JAR, 100 x 100 mm
3509	178	HMI-GS-3501	DRESSING JAR, 125 x 125 mm
3510	178	HMI-GS-3502	DRESSING JAR, 150 x 150 mm
3511	178	HMI-GS-3503	DRESSING JAR, 200 x 200 mm
3512	178	HMI-GS-3504	DRESSING JAR, 80 x 80 mm
3513	178	HMI-GS-3505	DRESSING JAR, 100 x 100 mm
3514	178	HMI-GS-3506	DRESSING JAR, 125 x 125 mm
3515	178	HMI-GS-3507	DRESSING JAR, 150 x 150 mm
3516	178	HMI-GS-3508	DRESSING JAR, 200 x 200 mm
3517	179	HMI-GS-3509	FORCEPS JAR, 55 x 100 mm
3518	179	HMI-GS-3510	FORCEPS JAR, 55 x 140 mm
3519	179	HMI-GS-3511	FORCEPS JAR, 55 x 170 mm
3520	179	HMI-GS-3512	FORCEPS JAR, 55 x 180 mm
3521	179	HMI-GS-3513	FORCEPS JAR, 80 x 100 mm
3522	179	HMI-GS-3514	FORCEPS JAR, 55 x 100 mm
3523	179	HMI-GS-3515	FORCEPS JAR, 55 x 140 mm






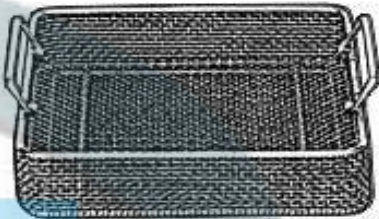
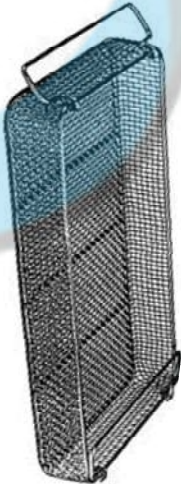
3524	179	HMI-GS-3516	FORCEPS JAR, 55 x 170 mm
3525	179	HMI-GS-3517	FORCEPS JAR, 55 x 180 mm
3526	179	HMI-GS-3518	FORCEPS JAR, 80 x 100 mm
3527	179	HMI-GS-3519	FORCEPS JAR, 55 x 100 mm
3528	179	HMI-GS-3520	FORCEPS JAR, 55 x 140 mm
3529	179	HMI-GS-3521	FORCEPS JAR, 55 x 170 mm
3530	179	HMI-GS-3522	FORCEPS JAR, 55 x 180 mm
3531	179	HMI-GS-3523	FORCEPS JAR, 80 x 100 mm
3532	179	HMI-GS-3524	FORCEPS JAR, 55 x 100 mm
3533	179	HMI-GS-3525	FORCEPS JAR, 55 x 140 mm
3534	179	HMI-GS-3526	FORCEPS JAR, 55 x 170 mm
3535	179	HMI-GS-3527	FORCEPS JAR, 55 x 180 mm
3536	179	HMI-GS-3528	FORCEPS JAR, 80 x 100 mm
3537	179	HMI-GS-3529	FORCEPS JAR, 55 x 100 mm
3538	179	HMI-GS-3530	FORCEPS JAR, 55 x 140 mm
3539	179	HMI-GS-3531	FORCEPS JAR, 55 x 170 mm



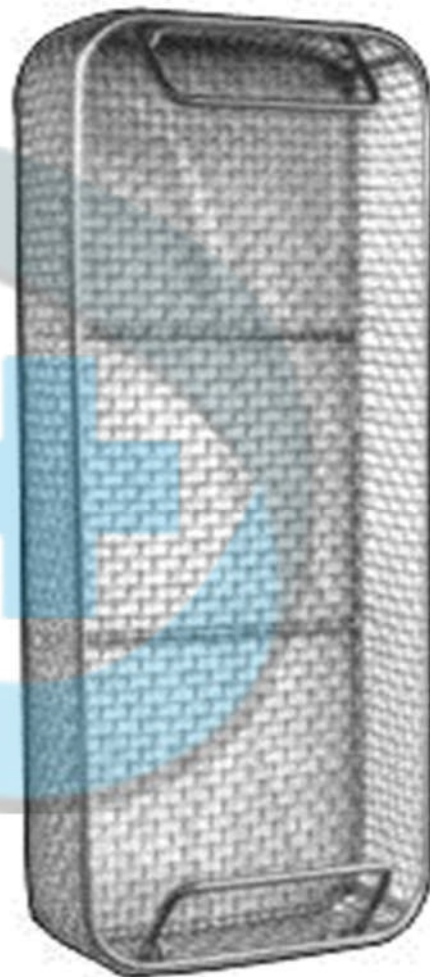
3540	179	HMI-GS-3532	FORCEPS JAR, 55 x 180 mm	
3541	179	HMI-GS-3533	FORCEPS JAR, 80 x 100 mm	
3542	179	HMI-GS-3534	COTTON HOLDER	
3543	179	HMI-GS-3535	GALIPOTS Capacity, 2 Ounces	
3544	179	HMI-GS-3536	GALIPOTS Capacity, 3 Ounces	
3545	179	HMI-GS-3537	GALIPOTS Capacity, 4 Ounces	
3546	179	HMI-GS-3538	GALIPOTS Capacity, 5 Ounces	
3547	179	HMI-GS-3539	GALIPOTS Capacity, 6 Ounces	
3548	179	HMI-GS-3540	GALIPOTS Capacity, 7 Ounces	
3549	179	HMI-GS-3541	GALIPOTS Capacity, 8 Ounces	
3550	179	HMI-GS-3542	GALIPOTS Capacity, 2 Ounces	
3551	179	HMI-GS-3543	GALIPOTS Capacity, 3 Ounces	
3552	179	HMI-GS-3544	GALIPOTS Capacity, 4 Ounces	
3553	179	HMI-GS-3545	GALIPOTS Capacity, 5 Ounces	
3554	179	HMI-GS-3546	GALIPOTS Capacity, 6 Ounces	

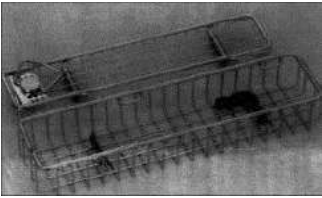


3555	179	HMI-GS-3547	GALIPOTS Capacity, 7 Ounces	
3556	179	HMI-GS-3548	GALIPOTS Capacity, 8 Ounces	
3557	179	HMI-GS-3549	SPRIT LAMP 100 ml.	
3558	179	HMI-GS-3550	INDO BOX ROUND	
3559	179	HMI-GS-3551	NEEDLE CASE	
3560	179	HMI-GS-3552	MEASURING JUG, Capacity, 1.00 Ltr	
3561	179	HMI-GS-3553	MEASURING JUG, Capacity, 1.50 Ltr	
3562	179	HMI-GS-3554	MEASURING JUG, Capacity, 2.00 Ltr	
3563	179	HMI-GS-3555	MEDICINE CUP GRADUATED 50 ml	
3564	179	HMI-GS-3556	MEDICINE CUP GRADUATED 60 ml	
3565	179	HMI-GS-3557	MEDICINE CUP GRADUATED 100 ml	
3566	179	HMI-GS-3558	BUCKET WITH LID Capacity 10 Ltr	
3567	179	HMI-GS-3559	BUCKET WITH LID Capacity 12 Ltr	

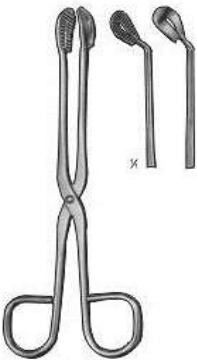




3568	179	HMI-GS-3560	BUCKET WITH LID Capacity 15 Ltr	
3569	180	HMI-GS-3561	SPUTUM MUG 100 x 50 mm	
3570	180	HMI-GS-3562	ENEMA CANE Capacity 0.5 Ltr	
3571	180	HMI-GS-3563	ENEMA CANE Capacity 1.5 Ltr	
3572	180	HMI-GS-3564	ENEMA CANE Capacity 2.0 Ltr	
3573	180	HMI-GS-3565	DUST BIN 20 Lit	
3574	180	HMI-GS-3566	ROUND BADPAN 300 x 85 mm	
3575	180	HMI-GS-3567	BEDPAN Size: Adult, Child	
3576	180	HMI-GS-3568	BEDPAN Size: Adult, Child	
3577	180	HMI-GS-3569	FURNAL 100 mm	



3578	180	HMI-GS-3570	URINAL - FEMALE	
3579	180	HMI-GS-3571	URINAL - MALE	
3580	180	HMI-GS-3572	SHAVING MUG 100 mm	
3581	181	HMI-GS-3573	MESH BASKET 240 x 258 x 50 mm	
3582	181	HMI-GS-3574	MESH BASKET 250 x 240 x 100 mm	
3583	181	HMI-GS-3575	MESH BASKET 240 x 250 x 60mm	
3584	181	HMI-GS-3576	MESH BASKET 480 x 258 x 50 mm	
3585	181	HMI-GS-3577	MESH BASKET 480 x 258 x 100 mm	
3586	181	HMI-GS-3578	MESH BASKET 520 x 258 x 60mm	
3587	181	HMI-GS-3579	MESH BASKET 520 x 258 x 70mm	
3588	181	HMI-GS-3580	MESH BASKET 450 x 340 x 70mm	
3589	181	HMI-GS-3581	MESH BASKET 320 x 230 x 70mm	
3590	181	HMI-GS-3582	MESH BASKET With Perforated Sheet Side 230 x 130 x 50 mm	

3591	181	HMI-GS-3583	MESH BASKET With Perforated Sheet Side 230 x 130 x 60 mm
3592	181	HMI-GS-3584	MESH BASKET With Perforated Sheet Side 240 x 130 x 50 mm
3593	181	HMI-GS-3585	MESH BASKET With Perforated Sheet Side 240 x 130 x 60 mm
3594	181	HMI-GS-3586	MESH BASKET With Perforated Sheet Side 240 x 250 x 50 mm
3595	181	HMI-GS-3587	MESH BASKET With Perforated Sheet Side 240 x 250 x 60 mm
3596	181	HMI-GS-3588	MESH BASKET With Perforated Sheet Side 480 x 250 x 50 mm
3597	181	HMI-GS-3589	MESH BASKET With Perforated Sheet Side 480 x 250 x 60 mm
3598	181	HMI-GS-3590	MESH BASKET With Perforated Sheet Side 480 x 250 x 70 mm
3599	181	HMI-GS-3591	MESH BASKET With Perforated Sheet Side 300 x 300 x 50 mm
3600	181	HMI-GS-3592	MESH BASKET With Perforated Sheet Side 350 x 350 x 60 mm
3601	181	HMI-GS-3593	MESH BASKET With Perforated Sheet Side 470 x 400 x 60 mm
3602	181	HMI-GS-3594	MESH BASKET With Perforated Sheet Side 480 x 480 x 50 mm
3603	181	HMI-GS-3595	MESH BASKET With Perforated Sheet Side 480 x 480 x 60 mm
3604	181	HMI-GS-3596	MESH BASKET With Perforated Sheet Side 500 x 300 x 50 mm
3605	181	HMI-GS-3597	MESH BASKET With Perforated Sheet Side 520 x 300 x 50 mm
3606	181	HMI-GS-3598	MESH BASKET With Perforated Sheet Side 520 x 300 x 60 mm



3607	181	HMI-GS-3599	MESH BASKET With Perforated Sheet Side 550 x 430 x 50 mm	
3608	181	HMI-GS-3600	MESH BASKET With Perforated Sheet Side 600 x 300 x 60 mm	
3609	181	HMI-GS-3601	ARTHROSCOPE BASKET 290 x 80 x 52 mm	
3610	181	HMI-GS-3602	ENDOSCOPE BASKET 460 x 80 x 52 mm	
3611	181	HMI-GS-3603	ENDOSCOPE BASKET 660 x 80 x 52 mm	
3612	181	HMI-GS-3604	ENDOSCOPE BASKET 670 x 80 x 52 mm	
3613	182	HMI-GS-3605	DAVIS 16 cm, 6 1/4"	
3614	182	HMI-GS-3606	DAVIS 20 cm, 8"	
3615	182	HMI-GS-3607	DAVIS 24 cm, 9 1/2"	

3616	182	HMI-GS-3608	UTILITY 20 cm, 8"	
3617	182	HMI-GS-3609	UTILITY 28 cm, 11"	
3618	182	HMI-GS-3610	CHEATEL 28 cm	
3619	182	HMI-GS-3611	LONDON PATT 28 cm	
3620	182	HMI-GS-3612	HARRISON 25 cm	
3621	182	HMI-GS-3613	HARRISON 30 cm	
3622	182	HMI-GS-3614	HARRISON 36 cm	
3623	182	HMI-GS-3615	HARRISON 46 cm	
3624	182	HMI-GS-3616	HARRISON 20 cm, 8"	
3625	182	HMI-GS-3617	HARRISON 25 cm, 10"	
3626	182	HMI-GS-3618	HARRISON 30 cm, 11 3/4"	

3627	182	HMI-GS-3619	ROGGE 27 cm, 11"	
3628	182	HMI-GS-3620	CHEATEL Box Joint 27 cm, 11"	





































































































































































































































































































)















































































































































































































































































