















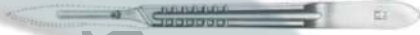

































PRICE LIST of COMPLETE SURGERY INSTRUMENTS (HMI-SI)			
Sr.	Code	Description	Image
Dissecting Knives			
1	HMI-SI-001	Dissecting Knife with metal handle 30 mm 15 cm / 5 7/ 8"	
2	HMI-SI-002	Dissecting Knife with metal handle 36 mm 15 cm / 5 7/ 8"	
3	HMI-SI-003	Dissecting Knife with metal handle 40 mm 15,5 cm / 6 1/ 8"	
4	HMI-SI-004	Dissecting Knife with metal handle 45 mm 16 cm / 6 2/ 8"	
5	HMI-SI-005	Dissecting Knife with metal handle 27 mm 16 cm / 6 2/ 8"	
6	HMI-SI-006	Dissecting Knife with metal handle 35 mm 15 cm / 5 7/ 8"	
7	HMI-SI-007	Dissecting Knife with metal handle 40 mm 15 cm / 5 7/ 8"	
8	HMI-SI-008	Dissecting Knife with metal handle 47mm 16 cm / 6 2/ 8"	
9	HMI-SI-009	Dissecting Knife with metal handle 30 mm 16 cm / 6 2/ 8"	
10	HMI-SI-010	Dissecting Knife with metal handle 30 mm 17 cm / 6 6/ 8"	
Scalpels			
11	HMI-SI-011	Virchow Scalpel with with hollow handle 160 mm 26 cm / 10 1/4"	
12	HMI-SI-012	Virchow Scalpel with with hollow handle 200 mm 33,5 cm / 13 1/4"	
13	HMI-SI-013	Virchow Scalpel with with hollow handle 240 mm 38 cm / 15	
Blade Holders / Blade Breakers			
15	HMI-SI-014	Troutman-Chris Blade Breakers 5,5 mm 9 cm / 3 4/8"	
16	HMI-SI-015	Troutman-Chris Blade Breakers 5,5 mm 11 cm / 4 3/8"	













17	HMI-SI-016	Troutman-Chris Blade Breakers 13 cm / 5 1/8"	
18	HMI-SI-017	Troutman-Chris Blade Breakers 8 mm 13 cm / 5 1/8"	
19	HMI-SI-018	Razor Blades breakable package with 10 units	
Scalpel Handles			
20	HMI-SI-019	Solid Scalpel Handles 13,5 cm / 5 3/8"	
21	HMI-SI-020	Solid Scalpel Handles 16 cm / 6 2/8"	
22	HMI-SI-021	Solid Scalpel Handles 21 cm / 8 2/8"	
23	HMI-SI-022	Solid Scalpel Handles 20,5 cm / 8 1/8"	
24	HMI-SI-023	Collin Scalpel Handles with hollow handle 13,5 cm / 5 3/8"	





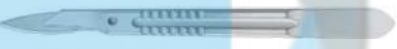



25	HMI-SI-024	Collin Scalpel Handles with hollow handle 14,5 cm / 5 6/8"	
26	HMI-SI-025	Scalpel Handles with plastic handle 13,5 cm / 5 3/8"	
27	HMI-SI-026	Scalpel with Swivel Head 16 cm / 6 2/8"	
28	HMI-SI-027	Scalpel with Swivel Head 16 cm / 6 2/8"	
29	HMI-SI-028	Scalpel with Swivel Head 15,5 cm / 6 1/8"	
30	HMI-SI-029	Scalpel with Swivel Head 16,5 cm / 6 2/8"	
31	HMI-SI-030	Scalpel Handle left curved upwards 12 cm / 4 6/8"	
32	HMI-SI-031	Scalpel Handle right curved upwards 12 cm / 4 6/8"	









33	HMI-SI-032	Scalpel Handle Solid 12 cm / 4 6/8"	
34	HMI-SI-033	Scalpel Handle Solid 12 cm / 4 6/8"	
35	HMI-SI-034	Scalpel Handle Solid, cm-graduation 12 cm / 4 6/8"	
36	HMI-SI-035	Scalpel Handle Solid, long 21,5 cm / 8 4/8"	
37	HMI-SI-035(a)	Scalpel Handle Solid, long 20,5 cm / 8 1/8"	
38	HMI-SI-036	Scalpel Handle Solid, long 26 cm / 10 2/8"	
39	HMI-SI-037	Scalpel Handle Solid 16 cm / 6 2/8"	
40	HMI-SI-038	Scalpel Handle Solid 12,5 cm / 4 7/8"	

41	HMI-SI-039	Scalpel Handle with round hollow handle 15,5 cm / 6 1/8"	
42	HMI-SI-040	Scalpel Handle with plastic handle 12,5 cm / 4 7/8"	
43	HMI-SI-041	Scalpel Handle Solid 14 cm / 5 4/8"	
44	HMI-SI-042	Scalpel Handle Solid 14 cm / 5 4/8"	
45	HMI-SI-043	Scalpel Handle Solid 15 cm / 5 7/8"	
46	HMI-SI-044	Saw Blade for handles no. 3 package with 1 unit	
47	HMI-SI-045	Scalpel Blade non-sterile	
48	HMI-SI-050	Scalpel Blade Sterile	
49	HMI-SI-046	Scalpel Blade non-sterile	
50	HMI-SI-051	Scalpel Blade Sterile	
51	HMI-SI-047	Scalpel Blade non-sterile	
52	HMI-SI-052	Scalpel Blade Sterile	
53	HMI-SI-048	Scalpel Blade non-sterile	







54	HMI-SI-053	Scalpel Blade Sterile	
55	HMI-SI-049	Scalpel Blade non-sterile	
56	HMI-SI-054	Scalpel Blade Sterile	
57	HMI-SI-055	Scalpel Blade non-sterile	
58	HMI-SI-059	Scalpel Blade Sterile	
59	HMI-SI-056	Scalpel Blade non-sterile	
60	HMI-SI-060	Scalpel Blade Sterile	
61	HMI-SI-057	Scalpel Blade non-sterile	
62	HMI-SI-061	Scalpel Blade Sterile	
63	HMI-SI-058	Scalpel Blade non-sterile	
64	HMI-SI-062	Scalpel Blade Sterile	
65	HMI-SI-063	Scalpel Blade Remover	
66	HMI-SI-064	Scalpel Blade non-sterile	
67	HMI-SI-069	Scalpel Blade Sterile	
68	HMI-SI-065	Scalpel Blade non-sterile	
69	HMI-SI-070	Scalpel Blade Sterile	
70	HMI-SI-066	Scalpel Blade non-sterile	
71	HMI-SI-071	Scalpel Blade Sterile	
72	HMI-SI-067	Scalpel Blade non-sterile	
73	HMI-SI-072	Scalpel Blade Sterile	
74	HMI-SI-068	Scalpel Blade non-sterile	
75	HMI-SI-073	Scalpel Blade Sterile	
76	HMI-SI-074	Scalpel Blade non-sterile	



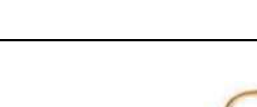

77	HMI-SI-078	Scalpel Blade Sterile	
78	HMI-SI-075	Scalpel Blade non-sterile	
79	HMI-SI-079	Scalpel Blade Sterile	
80	HMI-SI-076	Scalpel Blade non-sterile	
81	HMI-SI-080	Scalpel Blade Sterile	
82	HMI-SI-077	Scalpel Blade non-sterile	
83	HMI-SI-081	Scalpel Blade Sterile	
84	HMI-SI-082	Scalpel Handles for micro scapel blades 13,5 cm / 5 3/8"	
85	HMI-SI-083	Scalpel Handles for micro scapel blades 13,5 cm / 5 3/8"	
86	HMI-SI-084	Disposable Scalpels Sterile single packed package with 10 units	
87	HMI-SI-085	Disposable Scalpels Sterile single packed package with 10 units	
88	HMI-SI-086	Disposable Scalpels Sterile single packed package with 10 units	
89	HMI-SI-087	Disposable Scalpels Sterile single packed package with 10 units	





90	HMI-SI-088	Disposable Scalpels Sterile single packed package with 10 units	
91	HMI-SI-089	Disposable Scalpels Sterile single packed package with 10 units	
92	HMI-SI-090	Disposable Scalpels Sterile single packed package with 10 units	
93	HMI-SI-091	Disposable Scalpels Sterile single packed package with 10 units	
94	HMI-SI-092	Disposable Scalpels Sterile single packed package with 10 units	
95	HMI-SI-093	Disposable Scalpels Sterile single packed package with 10 units	
96	HMI-SI-094	Disposable Scalpels Sterile single packed package with 10 units	
97	HMI-SI-095	Disposable Scalpels Sterile single packed package with 10 units	













98	HMI-SI-096	Disposable Scalpels Sterile single packed package with 10 units	
99	HMI-SI-097	Disposable Scalpels Sterile single packed package with 10 units	
100	HMI-SI-098	Liston Amputation Knife 160 mm 29 cm / 11 3/8"	
101	HMI-SI-099	Liston Amputation Knife 190 mm 32 cm / 12 5/8"	
102	HMI-SI-100	Liston Amputation Knife 65 mm 19 cm / 7 4/8"	
103	HMI-SI-101	Langenbeck Amputation Knife 55 mm 18 cm / 7 1/8"	
104	HMI-SI-102	Langenbeck Amputation Knife 55 mm 18 cm / 7 1/8"	
Razor Knives			
105	HMI-SI-103	Razor Knife hollow blade on both sides 75 mm	





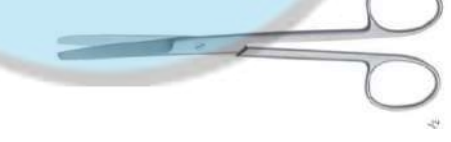

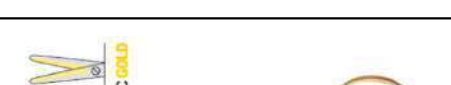





106	HMI-SI-104	Razor Knife blade flat/hollow 75 mm	
107	HMI-SI-105	Record-Arkansas Sharpening Stone, in wooden case 150 x 50 x 25 mm	
108	HMI-SI-106	Record-Arkansas Sharpening Stone 100 x 26 x 10/3 mm	
109	HMI-SI-107	Humby Razor Knife complete with blade 32 cm / 12 5/8"	
110	HMI-SI-108	Humby Razor Knife Spare Blade	
111	HMI-SI-109	Schink Razor Knife adjustable from 0.1 to 2.0 mm 30 cm / 11 6/8"	
112	HMI-SI-110	Schink Razor Knife Spare Blade	
113	HMI-SI-111	Schink Skin Fixing Plate	
114	HMI-SI-112	Dermatome Silver 19,5 cm / 7 5/8"	
115	HMI-SI-113	Dermatome Silver Spare Blades, package with 10 units	
Operating Scissors			
116	HMI-SI-301	Operating Scissors Standard 12 cm / 4 6/8"	
117	HMI-SI-302	Operating Scissors Standard 13 cm / 5 1/8"	
118	HMI-SI-303	Operating Scissors Standard 14,5 cm / 5 6/8"	
119	HMI-SI-304	Operating Scissors Standard 15,5 cm / 6 1/8"	
120	HMI-SI-305	Operating Scissors Standard 16,5 cm / 6 4/8"	
121	HMI-SI-306	Operating Scissors Standard 17,5 cm / 6 7/8"	





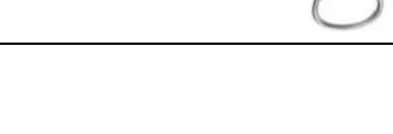

122	HMI-SI-307	Operating Scissors Standard 18,5 cm / 7 2/8"		
123	HMI-SI-308	Operating Scissors Standard 20,5 cm / 8 1/8"		
124	HMI-SI-309	Operating Scissors TCGOLD 14,5 cm / 5 6/8"		
125	HMI-SI-310	Operating Scissors Standard 12 cm / 4 6/8"		
126	HMI-SI-311	Operating Scissors Standard 13 cm / 5 1/8"		
127	HMI-SI-312	Operating Scissors Standard 14,5 cm / 5 6/8"		
128	HMI-SI-313	Operating Scissors Standard 15,5 cm / 6 1/8"		
129	HMI-SI-314	Operating Scissors Standard 16,5 cm / 6 4/8"		
130	HMI-SI-315	Operating Scissors Standard 17,5 cm / 6 7/8"		
131	HMI-SI-316	Operating Scissors Standard 18,5 cm / 7 2/8"		
132	HMI-SI-317	Operating Scissors Standard 20,5 cm / 8 1/8"		
133	HMI-SI-318	Operating Scissors TCGOLD 14,5 cm / 5 6/8"		
139	HMI-SI-319	Operating Scissors Super Cut 14,5 cm / 5 6/8"		
140	HMI-SI-320	Operating Scissors Standard 12 cm / 4 6/8"		





141	HMI-SI-321	Operating Scissors Standard 13 cm / 5 1/8"	
142	HMI-SI-322	Operating Scissors Standard 14,5 cm / 5 6/8"	
143	HMI-SI-323	Operating Scissors Standard 15,5 cm / 6 1/8"	
144	HMI-SI-324	Operating Scissors Standard 16,5 cm / 6 4/8"	
145	HMI-SI-325	Operating Scissors TCGOLD 14,5 cm / 5 6/8"	
146	HMI-SI-326	Operating Scissors Standard 12 cm / 4 6/8"	
147	HMI-SI-327	Operating Scissors Standard 13 cm / 5 1/8"	
148	HMI-SI-328	Operating Scissors Standard 14,5 cm / 5 6/8"	
149	HMI-SI-329	Operating Scissors Standard 15,5 cm / 6 1/8"	
150	HMI-SI-330	Operating Scissors Standard 16,5 cm / 6 4/8"	
151	HMI-SI-331	Operating Scissors Standard 17,5 cm / 6 7/8"	
152	HMI-SI-332	Operating Scissors Standard 18,5 cm / 7 2/8"	
153	HMI-SI-333	Operating Scissors Standard 20,5 cm / 8 1/8"	
154	HMI-SI-334	Operating Scissors TCGOLD 14,5 cm / 5 6/8"	
155	HMI-SI-335	Operating Scissors Standard 12 cm / 4 6/8"	
156	HMI-SI-336	Operating Scissors Standard 13 cm / 5 1/8"	
157	HMI-SI-337	Operating Scissors Standard 14,5 cm / 5 6/8"	
158	HMI-SI-338	Operating Scissors Standard 15,5 cm / 6 1/8"	
159	HMI-SI-339	Operating Scissors Standard 16,5 cm / 6 4/8"	
160	HMI-SI-340	Operating Scissors Standard 17,5 cm / 6 7/8"	
161	HMI-SI-341	Operating Scissors Standard 18,5 cm / 7 2/8"	

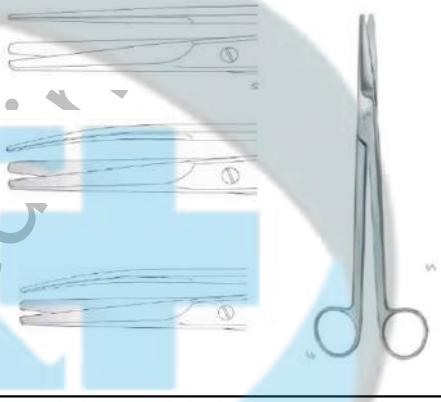





162	HMI-SI-342	Operating Scissors Standard 20,5 cm / 8 1/8"	
163	HMI-SI-343	Operating Scissors TCGOLD 14,5 cm / 5 6/8"	
164	HMI-SI-344	Operating Scissors Super Cut 14,5 cm / 5 6/8"	
165	HMI-SI-345	Operating Scissors Standard 12 cm / 4 6/8"	
166	HMI-SI-346	Operating Scissors Standard 13 cm / 5 1/8"	
167	HMI-SI-347	Operating Scissors Standard 14,5 cm / 5 6/8"	
168	HMI-SI-348	Operating Scissors Standard 15,5 cm / 6 1/8"	
169	HMI-SI-349	Operating Scissors Standard 16,5 cm / 6 4/8"	
170	HMI-SI-350	Operating Scissors TCGOLD14,5 cm / 5 6/8"	
171	HMI-SI-351	Operating Scissors 13 cm / 5 1/8"	
172	HMI-SI-352	Operating Scissors 14,5 cm / 5 6/8"	
173	HMI-SI-353	Operating Scissors 13 cm / 5 1/8"	
174	HMI-SI-354	Operating Scissors 14,5 cm / 5 6/8"	





175	HMI-SI-355	Operating Scissors 13 cm / 5 1/8"	
176	HMI-SI-356	Operating Scissors 14,5 cm / 5 6/8"	
177	HMI-SI-357	Operating Scissors 13 cm / 5 1/8"	
178	HMI-SI-358	Operating Scissors 14,5 cm / 5 6/8"	
179	HMI-SI-359	Operating Scissors 13 cm / 5 1/8"	
180	HMI-SI-360	Operating Scissors 14,5 cm / 5 6/8"	
181	HMI-SI-361	Operating Scissors 13 cm / 5 1/8"	
182	HMI-SI-362	Operating Scissors 14,5 cm / 5 6/8"	
183	HMI-SI-363	Incision Scissors 14,5 cm / 5 6/8"	
184	HMI-SI-363 (a)	Deaver Operating Scissors 14,5 cm / 5 6/8"	
185	HMI-SI-363(b)	Deaver Operating Scissors 14 cm / 5 4/8"	
186	HMI-SI-363(c)	Deaver Operating Scissors 14,5 cm / 5 6/8"	
187			
188	HMI-SI-363(d)	Operating Scissors Mayo Standard 14,5 cm / 5 6/8"	
189	HMI-SI-363(e)	Operating Scissors Mayo Standard 15 cm / 5 7/8"	
190	HMI-SI-363(f)	Operating Scissors Mayo Standard 17 cm / 6 6/8"	
191	HMI-SI-364	Operating Scissors Mayo Standard 23,5 cm / 9 2/8"	
192	HMI-SI-365	Operating Scissors TCGOLD 14,5 cm / 5 6/8"	







193	HMI-SI-366	Operating Scissors Mayo TCGOLD 17 cm / 6 6/8"	
194	HMI-SI-367	Operating Scissors Mayo TCGOLD 23,5 cm / 9 2/8"	
195	HMI-SI-368	Operating Scissors Mayo Super Cut 14,5 cm / 5 6/8"	
196	HMI-SI-369	Operating Scissors Mayo Super Cut 17 cm / 6 6/8"	
197	HMI-SI-370	Operating Scissors Super Mayo Cut 23,5 cm / 9 2/8"	
198	HMI-SI-371	Operating Scissors Mayo Standard 14,5 cm / 5 6/8"	
199	HMI-SI-372	Operating Scissors Mayo Standard 15 cm / 5 7/8"	
200	HMI-SI-373	Operating Scissors Mayo Standard 17 cm / 6 6/8"	
201	HMI-SI-374	Operating Scissors Mayo Standard 23,5 cm / 9 2/8"	
202	HMI-SI-375	Operating Scissors Mayo TCGOLD 14,5 cm / 5 6/8"	
203	HMI-SI-376	Operating Scissors Mayo TCGOLD 17 cm / 6 6/8"	
204	HMI-SI-377	Operating Scissors Mayo TCGOLD 23,5 cm / 9 2/8"	
205	HMI-SI-378	Operating Scissors Mayo Super Cut 14,5 cm / 5 6/8"	
206	HMI-SI-379	Operating Scissors Mayo Super Cut 17 cm / 6 6/8"	
207	HMI-SI-380	Operating Scissors Mayo Super Cut 23,5 cm / 9 2/8"	
208	HMI-SI-381	Dissecting Scissors Mayo-Stille Standard 15 cm / 5 7/8"	
209	HMI-SI-382	Dissecting Scissors Mayo-Stille Standard 17 cm / 6 6/8"	
210	HMI-SI-383	Dissecting Scissors Mayo-Stille TCGOLD 15 cm / 5 7/8"	
211	HMI-SI-384	Dissecting Scissors Mayo-Stille TCGOLD 17 cm / 6 6/8"	
212	HMI-SI-385	Dissecting Scissors Mayo-Stille Super Cut 15 cm / 5 7/8"	
213	HMI-SI-386	Dissecting Scissors Mayo-Stille Super Cut 17 cm / 6 6/8"	
214	HMI-SI-387	Dissecting Scissors Mayo-Stille Standard 15 cm / 5 7/8"	
215	HMI-SI-388	Dissecting Scissors Mayo-Stille Standard 17 cm / 6 6/8"	







216	HMI-SI-389	Dissecting Scissors Mayo-Stille TCGOLD 15 cm / 5 7/8"	
217	HMI-SI-390	Dissecting Scissors Mayo-Stille TCGOLD 17 cm / 6 6/8"	
218	HMI-SI-391	Dissecting Scissors Mayo-Stille Super Cut 15 cm / 5 7/8"	
219	HMI-SI-392	Dissecting Scissors Mayo-Stille Super Cut 17 cm / 6 6/8"	
220	HMI-SI-393	Dissecting Scissors Mayo-Stille 16 cm / 6 2/8"	
221	HMI-SI-394	Dissecting Scissors Mayo-Stille 19,5 cm / 7 5/8"	
222	HMI-SI-395	Dissecting Scissors Mayo-Stille 21,5 cm / 8 4/8"	
223	HMI-SI-396	Dissecting Scissors Mayo-Stille 16 cm / 6 2/8"	
224	HMI-SI-397	Dissecting Scissors Mayo-Stille 19,5 cm / 7 5/8"	
225	HMI-SI-398	Dissecting Scissors Mayo-Stille 21,5 cm / 8 4/8"	
226	HMI-SI-399	Dissecting Scissors Mayo- Harrington 23 cm / 9"	
227	HMI-SI-400	Dissecting Scissors Mayo- Harrington 23 cm / 9"	
228	HMI-SI-401	Dissecting Scissors Mayo- Harrington 28 cm / 11"	
229	HMI-SI-402	Dissecting Scissors Mayo-Noble 16,5 cm / 6 4/ 8"	
230	HMI-SI-403	Dissecting Scissors Mayo-Noble 16,5 cm / 6 4/ 8"	







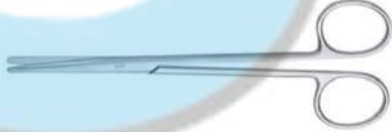



231	HMI-SI-404	Gynecological Scissors Sims Standard 20 cm / 7 7/8"	
232	HMI-SI-405	Gynecological Scissors Sims Standard 23 cm / 9"	
233	HMI-SI-406	Gynecological Scissors Sims TCGOLD 23 cm / 9"	
234	HMI-SI-407	Gynecological Scissors Sims Standard 20 cm / 7 7/8"	
235	HMI-SI-408	Gynecological Scissors Sims Standard 23 cm / 9"	
236	HMI-SI-409	Gynecological Scissors Sims TCGOLD 23 cm / 9"	
237	HMI-SI-410	Gynecological Scissors Sims AQUILA 20 cm / 7 7/8"	
238	HMI-SI-411	Gynecological Scissors Sims AQUILA 23 cm / 9"	





239	HMI-SI-412	Gynecological Scissors Sims TCCBlackLine 20 cm / 7 7/8"	
240	HMI-SI-413	Gynecological Scissors Sims TCCBlackLine 23 cm / 9"	
241	HMI-SI-414	Operating Scissors Kelly Standard 16 cm / 6 2/8"	
242	HMI-SI-415	Operating Scissors Kelly TCGOLD 16 cm / 6 2/8"	
243	HMI-SI-416	Operating Scissors Kelly Super Cut 16 cm / 6 2/8"	
244	HMI-SI-417	Operating Scissors Kelly Standard 16 cm / 6 2/8"	
245	HMI-SI-418	Operating Scissors Kelly TCGOLD 16 cm / 6 2/8"	
246	HMI-SI-419	Operating Scissors Kelly Super Cut 16 cm / 6 2/8"	



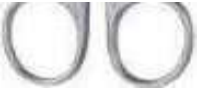

247	HMI-SI-420	Gynecological Scissors Doyen 18,5 cm / 7 2/8"	
248	HMI-SI-421	Gynecological Scissors Doyen 18,5 cm / 7 2/8"	
249	HMI-SI-422	Gynecological Scissors Sims-Siebold 24,5 cm / 9 5/8"	
250	HMI-SI-423	Gynecological Scissors Sims-Siebold 24,5 cm / 9 5/8"	
251	HMI-SI-424	Gynecological Scissors, Dissecting Scissors Wertheim 20 cm / 7 7/8"	
252	HMI-SI-425	Gynecological Scissors, Dissecting Scissors Wertheim 23 cm / 9"	
253	HMI-SI-426	Gynecological Scissors, Dissecting Scissors Wertheim 12 cm / 4 6/8"	





254	HMI-SI-427	Gynecological Scissors, Dissecting Scissors Wertheim 12 cm / 4 6/8"	
Dissecting Scissors			
255	HMI-SI-428	Dissecting Scissors Metzenbaum Standard 11,5 cm / 4 4/8"	
256	HMI-SI-429	Dissecting Scissors Metzenbaum TCGOLD 11,5 cm / 4 4/8"	
257	HMI-SI-430	Dissecting Scissors Metzenbaum Super Cut 11,5 cm / 4 4/8"	
258	HMI-SI-431	Dissecting Scissors Metzenbaum Standard 11,5 cm / 4 4/8"	
259	HMI-SI-432	Dissecting Scissors Metzenbaum TCGOLD 11,5 cm / 4 4/8"	
260	HMI-SI-433	Dissecting Scissors Metzenbaum Super Cut 11,5 cm / 4 4/8"	





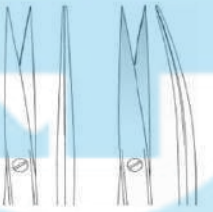

261	HMI-SI-434	Dissecting Scissors Metzenbaum AQUILA 11,5 cm / 4 4/8"	
262	HMI-SI-435	Dissecting Scissors Metzenbaum TCCBlackLine 11,5 cm / 4 4/8"	
263	HMI-SI-436	Dissecting Scissors Metzenbaum Standard 14,5 cm / 5 4/8"	
264	HMI-SI-437	Dissecting Scissors Metzenbaum TCGOLD 14,5 cm / 5 4/8"	
265	HMI-SI-438	Dissecting Scissors Metzenbaum Super Cut 14,5 cm / 5 4/8"	
266	HMI-SI-439	Dissecting Scissors Metzenbaum Standard 14,5 cm / 5 4/8"	
267	HMI-SI-440	Dissecting Scissors Metzenbaum TCGOLD 14,5 cm / 5 4/8"	







268	HMI-SI-441	Dissecting Scissors Metzenbaum Super Cut 14,5 cm / 5 4/8"	
269	HMI-SI-442	Dissecting Scissors Metzenbaum 14,5 cm / 5 4/8"	       
270	HMI-SI-443	Dissecting Scissors Metzenbaum 14,5 cm / 5 4/8"	
271	HMI-SI-444	Dissecting Scissors Metzenbaum 14,5 cm / 5 4/8"	
272	HMI-SI-445	Dissecting Scissors Metzenbaum 14,5 cm / 5 4/8"	
273	HMI-SI-446	Dissecting Scissors Metzenbaum 15,5 cm / 6 1/8"	
274	HMI-SI-447	Dissecting Scissors Metzenbaum 15,5 cm / 6 1/8"	
275	HMI-SI-448	Dissecting Scissors Metzenbaum-Nelson 18 cm / 7 1/8"	
276	HMI-SI-449	Dissecting Scissors Metzenbaum-Nelson 20,5 cm / 8 1/8"	
277	HMI-SI-450	Dissecting Scissors Metzenbaum Standard 18 cm / 7 1/8"	
278	HMI-SI-451	Dissecting Scissors Metzenbaum Standard 20,5 cm / 8 1/8"	
279	HMI-SI-452	Dissecting Scissors Metzenbaum Standard 23 cm / 9"	
280	HMI-SI-453	Dissecting Scissors Metzenbaum Standard 26 cm / 10 2/8"	
281	HMI-SI-454	Dissecting Scissors Metzenbaum Standard 28,5 cm / 11 2/8"	

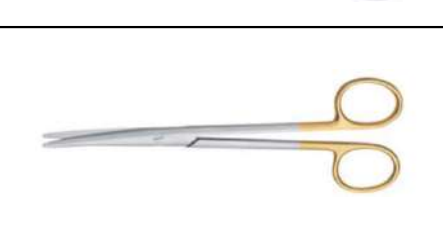



282	HMI-SI-455	Dissecting Scissors Metzenbaum Standard 31 cm / 12 2/8"	
283	HMI-SI-456	Dissecting Scissors Metzenbaum TCGOLD 18 cm / 7 1/8"	 TC GOLD
284	HMI-SI-457	Dissecting Scissors Metzenbaum TCGOLD 20,5 cm / 8 1/8"	
285	HMI-SI-458	Dissecting Scissors Metzenbaum TCGOLD 23 cm / 9"	
286	HMI-SI-459	Dissecting Scissors Metzenbaum TCGOLD 26 cm / 10 2/8"	
287	HMI-SI-460	Dissecting Scissors Metzenbaum TCGOLD 28,5 cm / 11 2/8"	
288	HMI-SI-461	Dissecting Scissors Metzenbaum TCGOLD 31 cm / 12 2/8"	
289	HMI-SI-462	Dissecting Scissors Metzenbaum SuperCut 18 cm / 7 1/8"	 SuperCut
290	HMI-SI-463	Dissecting Scissors Metzenbaum SuperCut 20,5 cm / 8 1/8"	
291	HMI-SI-464	Dissecting Scissors Metzenbaum SuperCut 23 cm / 9"	
292	HMI-SI-465	Dissecting Scissors Metzenbaum SuperCut 26 cm / 10 2/8"	
293	HMI-SI-466	Dissecting Scissors Metzenbaum SuperCut 28,5 cm / 11 2/8"	
294	HMI-SI-467	Dissecting Scissors Metzenbaum SuperCut 31 cm / 12 2/8"	
295	HMI-SI-468	Dissecting Scissors Metzenbaum Standard 18 cm / 7 1/8"	
296	HMI-SI-469	Dissecting Scissors Metzenbaum Standard 20,5 cm / 8 1/8"	
297	HMI-SI-470	Dissecting Scissors Metzenbaum Standard 23 cm / 9"	









298	HMI-SI-471	Dissecting Scissors Metzenbaum Standard 26 cm / 10 2/8"	
299	HMI-SI-472	Dissecting Scissors Metzenbaum Standard 28,5 cm / 11 2/8"	
300	HMI-SI-473	Dissecting Scissors Metzenbaum Standard 31 cm / 12 2/8"	
301	HMI-SI-474	Dissecting Scissors Metzenbaum TCGOLD 18 cm / 7 1/8"	
302	HMI-SI-475	Dissecting Scissors Metzenbaum TCGOLD 20,5 cm / 8 1/8"	
303	HMI-SI-476	Dissecting Scissors Metzenbaum TCGOLD 23 cm / 9"	
304	HMI-SI-477	Dissecting Scissors Metzenbaum TCGOLD 26 cm / 10 2/8"	
305	HMI-SI-478	Dissecting Scissors Metzenbaum TCGOLD 28,5 cm / 11 2/8"	
306	HMI-SI-479	Dissecting Scissors Metzenbaum TCGOLD 31 cm / 12 2/8"	
307	HMI-SI-480	Dissecting Scissors Metzenbaum SuperCut 18 cm / 7 1/8"	
308	HMI-SI-481	Dissecting Scissors Metzenbaum SuperCut 20,5 cm / 8 1/8"	
309	HMI-SI-482	Dissecting Scissors Metzenbaum SuperCut 23 cm / 9"	
310	HMI-SI-483	Dissecting Scissors Metzenbaum SuperCut 26 cm / 10 2/8"	
311	HMI-SI-484	Dissecting Scissors Metzenbaum SuperCut 28,5 cm / 11 2/8"	
312	HMI-SI-485	Dissecting Scissors Metzenbaum SuperCut 31 cm / 12 2/8"	
313	HMI-SI-486	Dissecting Scissors Metzenbaum AQUILA 18 cm / 7 1/8"	





314	HMI-SI-487	Dissecting Scissors Metzenbaum AQUILA 20,5 cm / 8 1/8"	
315	HMI-SI-488	Dissecting Scissors Metzenbaum AQUILA 23 cm / 9"	
316	HMI-SI-489	Dissecting Scissors Metzenbaum AQUILA 26 cm / 10 2/8"	
317	HMI-SI-490	Dissecting Scissors Metzenbaum AQUILA 28,5 cm / 11 2/8"	
318	HMI-SI-491	Dissecting Scissors Metzenbaum TCCBlackLine 18 cm / 7 1/8"	
319	HMI-SI-492	Dissecting Scissors Metzenbaum TCCBlackLine 20,5 cm / 8 1/8"	
320	HMI-SI-493	Dissecting Scissors Metzenbaum TCCBlackLine 23 cm / 9"	
321	HMI-SI-494	Dissecting Scissors Metzenbaum TCCBlackLine 26 cm / 10 2/8"	
322	HMI-SI-495	Dissecting Scissors Metzenbaum TCCBlackLine 31 cm / 12 2/8"	
323	HMI-SI-496	Dissecting Scissors Metzenbaum one toothed cutting edge 14,5 cm / 5 6/8"	
324	HMI-SI-497	Dissecting Scissors Metzenbaum one toothed cutting edge 14,5 cm / 5 6/8"	
325	HMI-SI-498	Dissecting Scissors Metzenbaum Nerve Dissecting Scissors 15,5 cm / 6 1/8"	





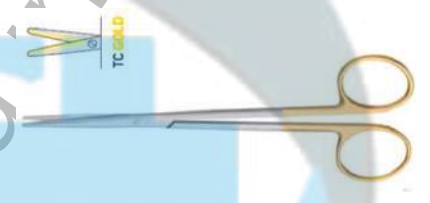
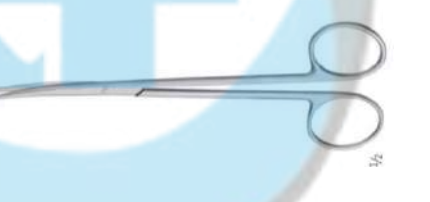

326	HMI-SI-499	Dissecting Scissors Metzenbaum Nerve Dissecting Scissors 15,5 cm / 6 1/8"	
327	HMI-SI-500	Dissecting Scissors Metzenbaum Kaye 18,5 cm / 7 2/8"	
328	HMI-SI-501	Dissecting Scissors Metzenbaum Gorney 12,5 cm / 4 7/8"	
329	HMI-SI-502	Dissecting Scissors Metzenbaum Gorney 19,5 cm / 7 5/8"	
330	HMI-SI-503	Dissecting Scissors Metzenbaum Gorney 19,5 cm / 7 5/8"	
331	HMI-SI-504	Dissecting Scissors Metzenbaum Gorney 17 cm / 6 6/8"	
332	HMI-SI-505	Dissecting Scissors Metzenbaum Lexer Standard 16 cm / 6 2/8"	
333	HMI-SI-506	Dissecting Scissors Metzenbaum Lexer TCGOLD 16 cm / 6 2/8"	



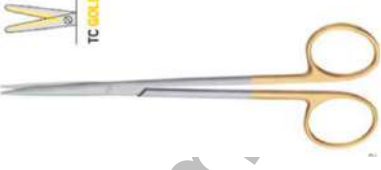

334	HMI-SI-507	Dissecting Scissors Metzenbaum Lexer Super Cut 16 cm / 6 2/8"	
335	HMI-SI-508	Dissecting Scissors Metzenbaum Lexer AQUILA 16 cm / 6 2/8"	
336	HMI-SI-509	Dissecting Scissors Metzenbaum Lexer TCCBlackLine 16 cm / 6 2/8"	
337	HMI-SI-510	Dissecting Scissors Metzenbaum Lexer Standard 16 cm / 6 2/8"	
338	HMI-SI-511	Dissecting Scissors Metzenbaum Lexer TCGOLD 16 cm / 6 2/8"	
339	HMI-SI-512	Dissecting Scissors Metzenbaum Lexer Super Cut 16 cm / 6 2/8"	
340	HMI-SI-513	Dissecting Scissors Metzenbaum Hohenfellner Standard 18 cm / 7 1/8"	
341	HMI-SI-514	Dissecting Scissors Metzenbaum Hohenfellner Standard 21 cm / 8 2/8"	

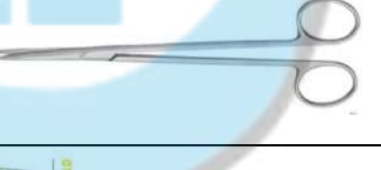



342	HMI-SI-515	Dissecting Scissors Metzenbaum Hohenfellner Standard 24 cm / 9 4/8"	
343	HMI-SI-516	Dissecting Scissors Metzenbaum Hohenfellner TCGOLD 18 cm / 7 1/8"	
344	HMI-SI-517	Dissecting Scissors Metzenbaum Hohenfellner TCGOLD 21 cm / 8 2/8"	
345	HMI-SI-518	Dissecting Scissors Metzenbaum Hohenfellner TCGOLD 24 cm / 9 4/8"	
346	HMI-SI-519	Dissecting Scissors Metzenbaum DeBakey Standard 17,5 cm / 6 7/8"	
347	HMI-SI-520	Dissecting Scissors Metzenbaum DeBakey Standard 20 cm / 7 7/8"	
348	HMI-SI-521	Dissecting Scissors Metzenbaum DeBakey TCGOLD 17,5 cm / 6 7/8"	
349	HMI-SI-522	Dissecting Scissors Metzenbaum DeBakey TCGOLD 20 cm / 7 7/8"	









350	HMI-SI-523	Dissecting Scissors Metzenbaum Cinelli 11,5 cm / 4 4/8"	
351	HMI-SI-524	Dissecting Scissors Metzenbaum Fomon 14 cm / 5 4/8"	
352	HMI-SI-525	Dissecting Scissors Metzenbaum Thorek 18,5 cm / 7 2/8"	
353	HMI-SI-526	Dissecting Scissors Lexer-Baby Standard 10 cm / 3 7/8"	
354	HMI-SI-527	Dissecting Scissors Lexer-Baby Super Cut 10 cm / 3 7/8"	
355	HMI-SI-528	Dissecting Scissors Lexer-Baby Standard 10 cm / 3 7/8"	
356	HMI-SI-529	Dissecting Scissors Lexer-Baby Super Cut 10 cm / 3 7/8"	
357	HMI-SI-530	Dissecting Scissors Lexer-Fino 16,5 cm / 6 4/8"	



358	HMI-SI-531	Dissecting Scissors Lexer-Fino 16,5 cm / 6 4/8"	
359	HMI-SI-532	Dissecting Scissors Metzenbaum-Fino 20,5 cm / 8 1/8"	
360	HMI-SI-533	Dissecting Scissors Metzenbaum-Fino 23 cm / 9"	
361	HMI-SI-534	Delicate Dissecting Scissors Metzenbaum-Fino Standard 14,5 cm / 5 6/8"	
362	HMI-SI-535	Delicate Dissecting Scissors Metzenbaum-Fino TCGOLD 14,5 cm / 5 6/8"	
363	HMI-SI-536	Delicate Dissecting Scissors Metzenbaum-Fino Standard 14,5 cm / 5 6/8"	
364	HMI-SI-537	Delicate Dissecting Scissors Metzenbaum-Fino TCGOLD 14,5 cm / 5 6/8"	
365	HMI-SI-538	Delicate Dissecting Scissors Metzenbaum-Fino Super Cut 14,5 cm / 5 6/8"	







366	HMI-SI-539	Delicate Dissecting Scissors Metzenbaum-Fino AQUILA 14,5 cm / 5 6/8"	
367	HMI-SI-540	Delicate Dissecting Scissors Metzenbaum-Fino Standard 14,5 cm / 5 6/8"	
368	HMI-SI-541	Delicate Dissecting Scissors Metzenbaum-Fino TCGOLD 14,5 cm / 5 6/8"	
369	HMI-SI-542	Delicate Dissecting Scissors Metzenbaum-Fino Standard 14,5 cm / 5 6/8"	
370	HMI-SI-543	Delicate Dissecting Scissors Metzenbaum-Fino TCGOLD 14,5 cm / 5 6/8"	
371	HMI-SI-544	Delicate Dissecting Scissors Metzenbaum-Fino Standard 18 cm / 7 1/8"	
372	HMI-SI-545	Delicate Dissecting Scissors Metzenbaum-Fino TCGOLD 18 cm / 7 1/8"	
373	HMI-SI-546	Delicate Dissecting Scissors Metzenbaum-Fino Standard 18 cm / 7 1/8"	

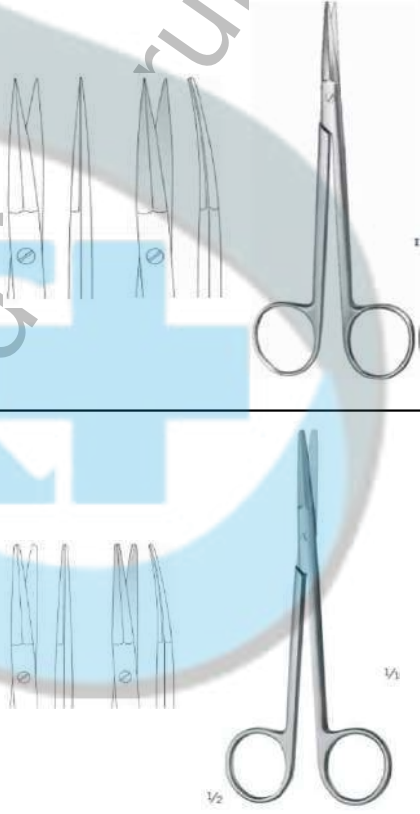







374	HMI-SI-547	Delicate Dissecting Scissors Metzenbaum-Fino Standard 20,5 cm / 8 1/8"	
375	HMI-SI-548	Delicate Dissecting Scissors Metzenbaum-Fino Standard 23 cm / 9"	
376	HMI-SI-549	Delicate Dissecting Scissors Metzenbaum-Fino TCGOLD 18 cm / 7 1/8"	
377	HMI-SI-550	Delicate Dissecting Scissors Metzenbaum-Fino TCGOLD 20,5 cm / 8 1/8"	
378	HMI-SI-551	Delicate Dissecting Scissors Metzenbaum-Fino TCGOLD 23 cm / 9"	
379	HMI-SI-552	Delicate Dissecting Scissors Metzenbaum-Fino SuperCut 18 cm / 7 1/8"	
380	HMI-SI-553	Delicate Dissecting Scissors Metzenbaum-Fino SuperCut 20,5 cm / 8 1/8"	
381	HMI-SI-554	Delicate Dissecting Scissors Metzenbaum-Fino SuperCut 23 cm / 9"	



382	HMI-SI-555	Delicate Dissecting Scissors Metzenbaum-Fino AQUILA 18 cm / 7 1/8"	
383	HMI-SI-556	Delicate Dissecting Scissors Metzenbaum-Fino Standard 18 cm / 7 1/8"	
384	HMI-SI-557	Delicate Dissecting Scissors Metzenbaum-Fino Standard 20,5 cm / 8 1/8"	
385	HMI-SI-558	Delicate Dissecting Scissors Metzenbaum-Fino Standard 23 cm / 9"	
386	HMI-SI-559	Delicate Dissecting Scissors Metzenbaum-Fino TCGOLD 18 cm / 7 1/8"	
387	HMI-SI-600	Delicate Dissecting Scissors Metzenbaum-Fino TCGOLD 20,5 cm / 8 1/8"	
388	HMI-SI-600(a)	Delicate Dissecting Scissors Metzenbaum-Fino TCGOLD 23 cm / 9"	
389	HMI-SI-601	Delicate Dissecting Scissors Salyer delicate pattern, one cutting edge with knife cut 18 cm / 7 1/8"	









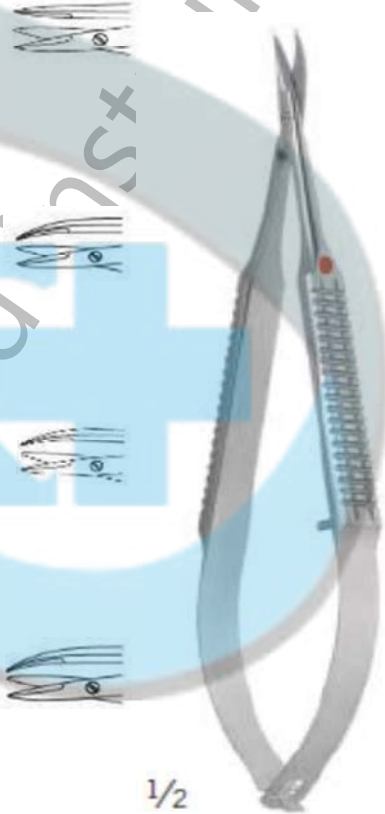

390	HMI-SI-602	Delicate Dissecting Scissors Salyer delicate pattern, one cutting edge with knife cut 12,5 cm / 4 7/8"	
391	HMI-SI-603	Delicate Dissecting Scissors Sanvenero 14 cm / 5 4/8"	
392	HMI-SI-604	Delicate Dissecting Scissors Sanvenero 14 cm / 5 4/8"	
393	HMI-SI-605	Delicate Dissecting Scissors 11 cm / 4 3/8"	
394	HMI-SI-606	Delicate Dissecting Scissors 11 cm / 4 3/8"	
395	HMI-SI-607	Operating Scissors Joseph Standard 14,5 cm / 5 6/8"	
396	HMI-SI-608	Operating Scissors Joseph TCGOLD 14,5 cm / 5 6/8"	
397	HMI-SI-609	Operating Scissors Joseph SuperCut 14,5 cm / 5 6/8"	





398	HMI-SI-610	Operating Scissors Joseph Standard 14,5 cm / 5 6/8"	
399	HMI-SI-611	Operating Scissors Joseph TCGOLD 14,5 cm / 5 6/8"	
400	HMI-SI-612	Operating Scissors Joseph SuperCut 14,5 cm / 5 6/8"	
401	HMI-SI-613	Face-lift Scissors, Dissecting Scissors Peck-Joseph 14,5 cm / 5 6/8"	
402	HMI-SI-614	Face-lift Scissors, Dissecting Scissors Peck-Joseph 14,5 cm / 5 6/8"	
403	HMI-SI-615	Face-lift Scissors, Dissecting Scissors Peck-Joseph 14,5 cm / 5 6/8"	
404	HMI-SI-616	Face-lift Scissors, Dissecting Scissors Peck-Joseph 14,5 cm / 5 6/8"	
405	HMI-SI-617	Face-lift Scissors, Dissecting Scissors Shea Vein Graft 12 cm / 4 6/8"	

406	HMI-SI-618	Face-lift Scissors, Dissecting Scissors 13 cm / 5 1/8"	
407	HMI-SI-619	Face-lift Scissors, Dissecting Scissors Kilner Standard 15 cm / 5 7/8"	
408	HMI-SI-620	Face-lift Scissors, Dissecting Scissors Kilner Standard 12 cm / 4 6/8"	
409	HMI-SI-621	Face-lift Scissors, Dissecting Scissors Kilner SuperCut 15 cm / 5 7/8"	
410	HMI-SI-622	Face-lift Scissors, Dissecting Scissors Kilner SuperCut 12 cm / 4 6/8"	
411	HMI-SI-623	Dissecting Scissors, Vascular Scissors 14,5 cm / 5 6/8"	
412	HMI-SI-624	Dissecting Scissors, Vascular Scissors 14,5 cm / 5 6/8"	
413	HMI-SI-625	Dissecting Scissors, Vascular Scissors Reynolds 15,5 cm / 6 1/8"	





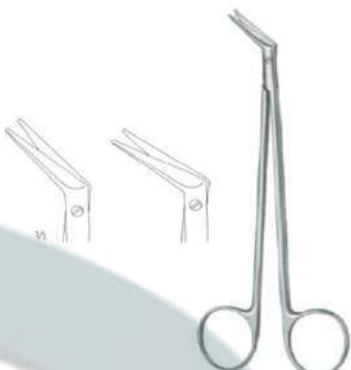













414	HMI-SI-626	Dissecting Scissors, Vascular Scissors Jameson 15,5 cm / 6 1/8"	
415	HMI-SI-627	Dissecting Scissors, Vascular Scissors Jameson one toothed cutting edge 15,5 cm / 6 1/8"	
416	HMI-SI-628	Dissecting Scissors, Vascular Scissors 14,5 cm / 5 6/8"	
417	HMI-SI-629	Dissecting Scissors, Vascular Scissors 14,5 cm / 5 6/8"	
418	HMI-SI-630	Dissecting Scissors, Vascular Scissors Reynolds 15,5 cm / 6 1/8"	
419	HMI-SI-631	Dissecting Scissors, Vascular Scissors Jameson 15,5 cm / 6 1/8"	
420	HMI-SI-632	Dissecting Scissors, Vascular Scissors Jameson one toothed cutting edge 15,5 cm / 6 1/8"	
421	HMI-SI-633	Dissecting Scissors, Vascular Scissors Reynolds Standard 15,5 cm / 6 1/8"	

422	HMI-SI-634	Dissecting Scissors, Vascular Scissors Reynolds Standard 18 cm / 7 1/8"	
423	HMI-SI-635	Dissecting Scissors, Vascular Scissors Reynolds SuperCut 15,5 cm / 6 1/8"	
424	HMI-SI-636	Dissecting Scissors, Vascular Scissors Reynolds SuperCut 18 cm / 7 1/8"	
425	HMI-SI-637	Short Micro Scissors sharp/sharp 12 cm / 4 6/8" 7mm	
426	HMI-SI-638	Short Micro Scissors sharp/sharp 12 cm / 4 6/8" 7mm	
427	HMI-SI-639	Short Micro Scissors blunt/blunt 12 cm / 4 6/8" 7mm	
428	HMI-SI-640	Short Micro Scissors sharp/blunt 12 cm / 4 6/8" 7mm	
429	HMI-SI-641	Short Micro Scissors with button 12 cm / 4 6/8" 7mm	

430	HMI-SI-642	Short Micro Scissors sharp/sharp 12 cm / 4 6/8" 7mm	
431	HMI-SI-643	Short Micro Scissors sharp/sharp 12 cm / 4 6/8" 7mm	
432	HMI-SI-644	Short Micro Scissors blunt/blunt 12 cm / 4 6/8" 7mm	
433	HMI-SI-645	Short Micro Scissors sharp/blunt 12 cm / 4 6/8" 7mm	
434	HMI-SI-646	Short Micro Scissors with button 12 cm / 4 6/8" 7mm	
435	HMI-SI-647	Dissecting Scissors, Vascular Scissors 20 cm / 7 7/8"	
436	HMI-SI-648	Dissecting Scissors, Vascular Scissors 20 cm / 7 7/8"	
437	HMI-SI-649	Dissecting Scissors, Vascular Scissors Satinsky 25,5 cm / 10"	
			
			
			
Vascular Scissors			









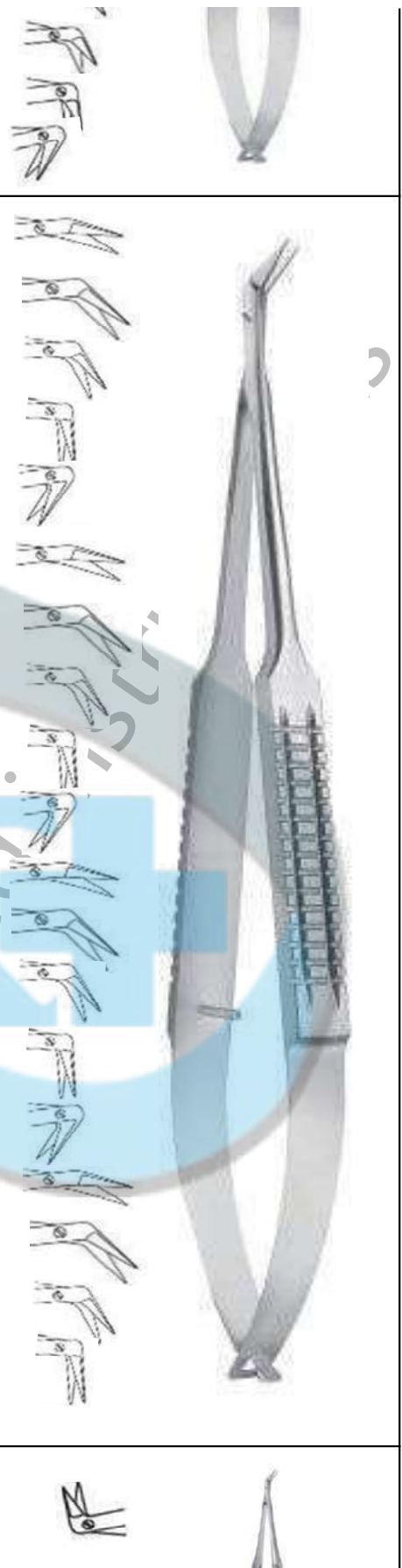



438	HMI-SI-650	Vascular Scissors, Coronary Scissors Diethrich-Salyer 12 cm / 4 6/8"	
439	HMI-SI-650(a)	Vascular Scissors, Coronary Scissors De Bakey 16 cm / 6 2/8"	
440	HMI-SI-651	Vascular Scissors, Coronary Scissors Diethrich 17,5 cm / 6 7/8" 20 mm	
441	HMI-SI-652	Vascular Scissors, Coronary Scissors Diethrich 17,5 cm / 6 7/8" 23 mm	
442	HMI-SI-653	Vascular Scissors Dietrich-Potts 18 cm / 7 1/8" 25° 10mm	
443	HMI-SI-654	Vascular Scissors Dietrich-Potts 18 cm / 7 1/8" 45° 10mm	
444	HMI-SI-655	Vascular Scissors Dietrich-Potts 18 cm / 7 1/8" 60° 10mm	
445	HMI-SI-656	Vascular Scissors Dietrich-Potts 18 cm / 7 1/8" 90° 10mm	
446	HMI-SI-657	Vascular Scissors Dietrich-Potts 18 cm / 7 1/8" 125° 10mm	
447	HMI-SI-658	Vascular Scissors Dietrich-Potts SuperCut 18 cm / 7 1/8" 25° 10mm	
448	HMI-SI-659	Vascular Scissors Dietrich-Potts SuperCut 18 cm / 7 1/8" 45° 10mm	
449	HMI-SI-660	Vascular Scissors Dietrich-Potts SuperCut 18 cm / 7 1/8" 60° 10mm	
450	HMI-SI-661	Vascular Scissors Dietrich-Potts SuperCut 18 cm / 7 1/8" 90° 10mm	
451	HMI-SI-662	Vascular Scissors Dietrich-Potts SuperCut 18 cm / 7 1/8" 125° 10mm	





452	HMI-SI-663	Vascular Scissors Dietrich-Potts 18 cm / 7 1/8" 25° 7mm	
453	HMI-SI-664	Vascular Scissors Dietrich-Potts 18 cm / 7 1/8" 45° 7mm	
454	HMI-SI-665	Vascular Scissors Dietrich-Potts 18 cm / 7 1/8" 60° 7mm	
455	HMI-SI-666	Vascular Scissors Dietrich-Potts 18 cm / 7 1/8" 90° 7mm	
456	HMI-SI-667	Vascular Scissors Dietrich-Potts 18 cm / 7 1/8" 125° 7mm	
457	HMI-SI-668	Vascular Scissors Dietrich-Potts SuperCut 18 cm / 7 1/8" 25° 7mm	
458	HMI-SI-669	Vascular Scissors Dietrich-Potts SuperCut 18 cm / 7 1/8" 45° 7mm	
459	HMI-SI-670	Vascular Scissors Dietrich-Potts SuperCut 18 cm / 7 1/8" 60° 7mm	
460	HMI-SI-671	Vascular Scissors Dietrich-Potts SuperCut 18 cm / 7 1/8" 90° 7mm	
461	HMI-SI-672	Vascular Scissors Dietrich-Potts SuperCut 18 cm / 7 1/8" 125° 7mm	
462	HMI-SI-673	Vascular Scissors Dietrich- Hegemann 18 cm / 7 1/8" 25° 15mm	
463	HMI-SI-674	Vascular Scissors Dietrich- Hegemann 18 cm / 7 1/8" 45° 15mm	
464	HMI-SI-675	Vascular Scissors Dietrich- Hegemann 18 cm / 7 1/8" 60° 15mm	
465	HMI-SI-676	Vascular Scissors Dietrich- Hegemann 18 cm / 7 1/8" 90° 15mm	
466	HMI-SI-677	Vascular Scissors Dietrich- Hegemann 18 cm / 7 1/8" 125° 15mm	
467	HMI-SI-678	Vascular Scissors Dietrich- Hegemann 14 cm / 5 4/8" 25° 15mm	
468	HMI-SI-679	Vascular Scissors Dietrich- Hegemann 14 cm / 5 4/8" 45° 15mm	
469	HMI-SI-680	Vascular Scissors Dietrich- Hegemann 14 cm / 5 4/8" 60° 15mm	





470	HMI-SI-681	Vascular Scissors Dietrich-Hegemann 14 cm / 5 4/8" 90° 15mm	
471	HMI-SI-682	Vascular Scissors Dietrich-Hegemann 14 cm / 5 4/8" 125° 15mm	
472	HMI-SI-683	Vascular Scissors Potts-Smith 18 cm / 7 1/8" 20 mm 60°	        
473	HMI-SI-684	Vascular Scissors Potts-Smith 18 cm / 7 1/8" 20 mm 60°	
474	HMI-SI-685	Vascular Scissors Potts-Smith 18,5 cm / 7 2/8" 20 mm 40°	
475	HMI-SI-686	Vascular Scissors Potts-Smith 19 cm / 7 4/8" 20 mm 25°	
476	HMI-SI-687	Vascular Scissors Potts-Smith 19,5 cm / 7 5/8" 20 mm	
477	HMI-SI-688	Vascular Scissors Potts-Smith 18 cm / 7 1/8" 20 mm 60°	
478	HMI-SI-689	Vascular Scissors Potts-Smith 18,5 cm / 7 2/8" 20 mm 40°	
479	HMI-SI-690	Vascular Scissors Potts-Smith 19 cm / 7 4/8" 20 mm 25°	
Micro Scissors			
480	HMI-SI-691	Micro Scissors St 18 cm / 7 1/8" 25° 7mm	       
481	HMI-SI-693	Micro Scissors St 18 cm / 7 1/8" 45° 7mm	
482	HMI-SI-695	Micro Scissors St 18 cm / 7 1/8" 60° 7mm	
483	HMI-SI-697	Micro Scissors St 18 cm / 7 1/8" 90° 7mm	
484	HMI-SI-699	Micro Scissors St 18 cm / 7 1/8" 125° 7mm	
485	HMI-SI-692	Micro Scissors Ti 18 cm / 7 1/8" 25° 7mm	
486	HMI-SI-694	Micro Scissors Ti 18 cm / 7 1/8" 45° 7mm	



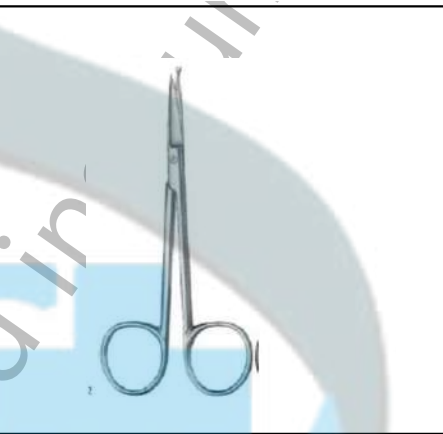
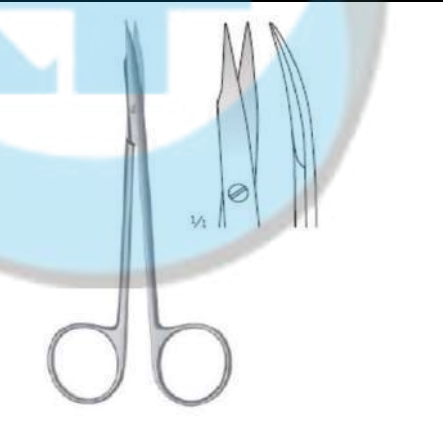
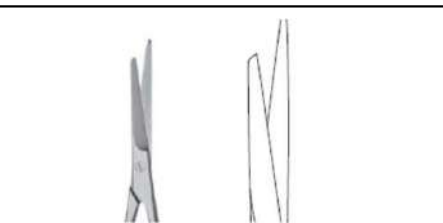

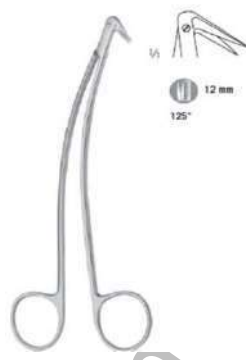
487	HMI-SI-696	Micro Scissors Ti 18 cm / 7 1/8" 60° 7mm
488	HMI-SI-698	Micro Scissors Ti 18 cm / 7 1/8" 90° 7mm
489	HMI-SI-700	Micro Scissors Ti 18 cm / 7 1/8" 125° 7mm
490	HMI-SI-701	Micro Scissors St 18 cm / 7 1/8" 25° 10mm
491	HMI-SI-705	Micro Scissors St 18 cm / 7 1/8" 45° 10mm
492	HMI-SI-709	Micro Scissors St 18 cm / 7 1/8" 60° 10mm
493	HMI-SI-713	Micro Scissors St 18 cm / 7 1/8" 90° 10mm
494	HMI-SI-717	Micro Scissors St 18 cm / 7 1/8" 125° 10mm
495	HMI-SI-702	Micro Scissors Ti 18 cm / 7 1/8" 25° 10mm
496	HMI-SI-706	Micro Scissors Ti 18 cm / 7 1/8" 45° 10mm
497	HMI-SI-710	Micro Scissors Ti 18 cm / 7 1/8" 60° 10mm
498	HMI-SI-714	Micro Scissors Ti 18 cm / 7 1/8" 90° 10mm
499	HMI-SI-718	Micro Scissors Ti 18 cm / 7 1/8" 125° 10mm
500	HMI-SI-703	Micro Scissors St 21 cm / 8 2/8" 25° 10mm
501	HMI-SI-707	Micro Scissors St 21 cm / 8 2/8" 45° 10mm
502	HMI-SI-711	Micro Scissors St 21 cm / 8 2/8" 60° 10mm
503	HMI-SI-715	Micro Scissors St 21 cm / 8 2/8" 90° 10mm
504	HMI-SI-719	Micro Scissors St 21 cm / 8 2/8" 125° 10mm
505	HMI-SI-704	Micro Scissors St 23 cm / 9" 25° 10mm
506	HMI-SI-708	Micro Scissors St 23 cm / 9" 45° 10mm
507	HMI-SI-712	Micro Scissors St 23 cm / 9" 60° 10mm
508	HMI-SI-716	Micro Scissors St 23 cm / 9" 90° 10mm
509	HMI-SI-720	Micro Scissors St 23 cm / 9" 125° 10mm
510	HMI-SI-721	Micro Scissors St 18 cm / 7 1/8" 25° 7mm
511	HMI-SI-722	Micro Scissors St 18 cm / 7 1/8" 45° 7mm







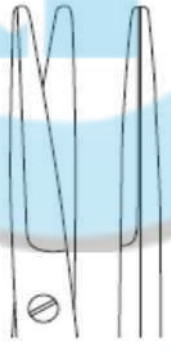





512	HMI-SI-723	Micro Scissors St 18 cm / 7 1/8" 60° 7mm		
513	HMI-SI-724	Micro Scissors St 18 cm / 7 1/8" 90° 7mm		
514	HMI-SI-724 (a)	Micro Scissors St 18 cm / 7 1/8" 125° 7mm		
515	HMI-SI-725	Micro Scissors St 18 cm / 7 1/8" 25° 10 mm		
516	HMI-SI-730	Micro Scissors St 21 cm / 8 2/8" 25° 10 mm	M	
517	HMI-SI-735	Micro Scissors St 23 cm / 9" 25° 10 mm	M	
518	HMI-SI-726	Micro Scissors St 18 cm / 7 1/8" 45° 10 mm	M	
519	HMI-SI-731	Micro Scissors St 21 cm / 8 2/8" 45° 10 mm	M	
520	HMI-SI-736	Micro Scissors St 23 cm / 9" 45° 10 mm	M	
521	HMI-SI-727	Micro Scissors St 18 cm / 7 1/8" 60° 10 mm	M	
522	HMI-SI-732	Micro Scissors St 21 cm / 8 2/8" 60° 10 mm	M	
523	HMI-SI-737	Micro Scissors St 23 cm / 9" 60° 10 mm	M	
524	HMI-SI-728	Micro Scissors St 18 cm / 7 1/8" 90° 10 mm	M	
525	HMI-SI-733	Micro Scissors St 21 cm / 8 2/8" 90° 10 mm	M	
526	HMI-SI-738	Micro Scissors St 23 cm / 9" 90° 10 mm	M	
527	HMI-SI-729	Micro Scissors St 18 cm / 7 1/8" 125° 10 mm	M	
528	HMI-SI-734	Micro Scissors St 21 cm / 8 2/8" 125° 10 mm	M	
529	HMI-SI-739	Micro Scissors St 23 cm / 9" 125° 10 mm	M	
530	HMI-SI-740	Micro Scissors St 18 cm / 7 1/8" 25° 10 mm		
531	HMI-SI-741	Micro Scissors St 18 cm / 7 1/8" 45° 10 mm		
532	HMI-SI-742	Micro Scissors St 18 cm / 7 1/8" 60° 10 mm		
533	HMI-SI-743	Micro Scissors St 18 cm / 7 1/8" 90° 10 mm		
534	HMI-SI-744	Micro Scissors St 18 cm / 7 1/8" 125° 10 mm		
535	HMI-SI-745	Micro Scissors St 18 cm / 7 1/8" 25° 10 mm		
536	HMI-SI-746	Micro Scissors St 18 cm / 7 1/8" 45° 10 mm		

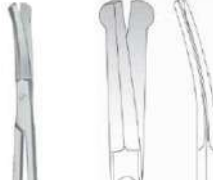



537	HMI-SI-746(a)	Micro Scissors St 18 cm / 7 1/8" 60° 10 mm	
538	HMI-SI-747	Micro Scissors St 18 cm / 7 1/8" 90° 10 mm	
539	HMI-SI-748	Micro Scissors St 18 cm / 7 1/8" 125° 10 mm	
540	HMI-SI-749	Vascular Scissors Favaloro 14,5 cm / 5 6/8" 40°	
541	HMI-SI-750	Vascular Scissors Favaloro 12 cm / 4 6/8"	
542	HMI-SI-751	Vascular Scissors Favaloro 14 cm / 5 4/8"	
543	HMI-SI-	Vascular Scissors Favaloro 14,5	





543	752	cm / 5 6/8"	
544	HMI-SI-753	Vascular Scissors Favaloro 18 cm / 7 1/8"	
545	HMI-SI-754	Vascular Scissors Favaloro 18 cm / 7 1/8"	
546	HMI-SI-755	Vascular Scissors Strully 22 cm / 8 5/8"	
547	HMI-SI-	Vascular Scissors Strully 22 cm / 8	





547	756	5/8"	
548	HMI-SI-757	Vascular Scissors Schmieden-Taylor 16,5 cm / 6 4/8"	
549	HMI-SI-758	Dissecting Scissors Toennis-Adson 17,5 cm / 6 7/8"	
550	HMI-SI-759	Dissecting Scissors Toennis 18 cm / 7 1/8"	
551	HMI-SI-	Dissecting Scissors Toennis 18 cm	





551	760	/ 7 1/8"	
552	HMI-SI-761	Dissecting Scissors Olivecrona	
553	HMI-SI-762	Dissecting Scissors McIndoe 18,5 cm / 7 2/8"	
554	HMI-SI-763	Tonsil Scissors Dean 17,5 cm / 6 7/8" 25°	
555	HMI-SI-	Tonsil Scissors Good 19,5 cm / 7	







555	764	5/8"	
556	HMI-SI-765	Tonsil Scissors Standard Dean 17,5 cm / 6 7/8" 25°	
557	HMI-SI-766	Tonsil Scissors TCGOLD Dean 17,5 cm / 6 7/8" 25°	
558	HMI-SI-767	Nasal Scissors Fomon 14,5 cm / 5 6/8" 40°	
559	HMI-SI-	Nasal Scissors Cottle 16 cm / 6	





559	768	2/8"	
560	HMI-SI-769	Nasal Scissors Fomon 14,5 cm / 5 6/8" 40°	
561	HMI-SI-770	Nasal Scissors Cottle 15,5 cm / 6 1/8" 40°	
562	HMI-SI-771	Nasal Scissors Heymann 18 cm / 7 1/8" 40°	
563	HMI-SI-	Nasal Scissors Heymann 18 cm / 7	

563	772	1/8" 40°	
564	HMI-SI-773	Nasal Scissors Converse 10,5 cm / 4 1/8" 40°	
565	HMI-SI-774	Nasal Scissors Converse 10,5 cm / 4 1/8" 40°	
566	HMI-SI-775	Episiotomy Scissors Waldmann 18 cm / 7 1/8"	
567	HMI-SI-	Episiotomy Scissors Braun-Stadler	





567	776	14,5 cm / 5 6/8" 35°	
568	HMI-SI-777	Episiotomy Scissors Braun-Stadler 22 cm / 8 5/8" 30°	
569	HMI-SI-778	Umbilical Scissors Mod. USA 10,5 cm / 4 1/8"	
570	HMI-SI-779	Umbilical Scissors Schuhmacher 15,5 cm / 6 1/8"	
571	HMI-SI-	Umbilical Scissors Busch 16 cm / 6	









780	2/8"		
572	HMI-SI-781	Umbilical Scissors Busch 16 cm / 6 2/8"	
573	HMI-SI-782	Operating Scissors Goldman-Fox Standard 13 cm / 5 1/8"	
574	HMI-SI-783	Operating Scissors Goldman-Fox TCGOLD 13 cm / 5 1/8"	
575	HMI-SI-	Operating Scissors Goldman-Fox	



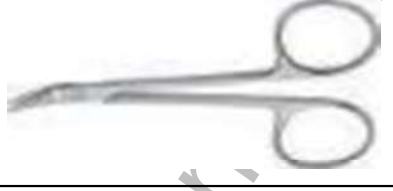

784		Standard 13 cm / 5 1/8"	
576	HMI-SI-785	Operating Scissors Goldman-Fox TCGOLD 13 cm / 5 1/8"	
577	HMI-SI-786	Operating Scissors Wagner 12 cm / 4 6/8"	
578	HMI-SI-787	Operating Scissors Wagner 12 cm / 4 6/8"	
579	HMI-SI-788	Operating Scissors 12 cm / 4 6/8"	
580	HMI-SI-789	Operating Scissors 12 cm / 4 6/8"	
581	HMI-SI-790	Operating Scissors 12 cm / 4 6/8"	
582	HMI-SI-791	Operating Scissors 12 cm / 4 6/8"	
583	HMI-SI-792	Operating Scissors 12 cm / 4 6/8"	
584	HMI-SI-793	Operating Scissors 12 cm / 4 6/8"	
585	HMI-SI-794	Operating Scissors La Grange 11,5 cm / 4 4/8"	
586	HMI-SI-795	Operating Scissors La Grange 11,5 cm / 4 4/8"	
587	HMI-SI-796	Operating Scissors La Grange 11,5 cm / 4 4/8"	

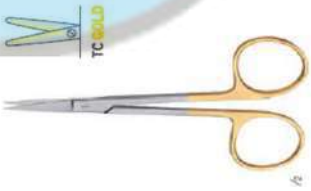



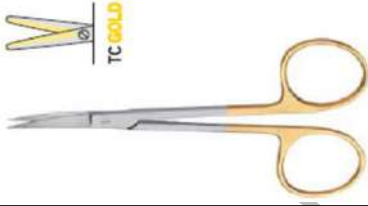

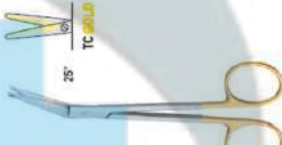
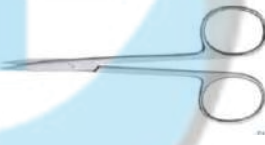
588	HMI-SI-797	Gum Scissors Standard 16 cm / 6 2/8" 25°	
589	HMI-SI-798	Gum Scissors TCGOLD 16 cm / 6 2/8" 25°	
590	HMI-SI-799	Gum Scissors Standard 16 cm / 6 2/8" 25°	
591	HMI-SI-800	Gum Scissors TCGOLD 16 cm / 6 2/8" 25°	



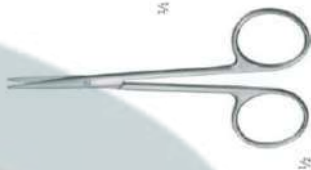

Iris Scissors

592	HMI-SI-801	Iris Scissors 9 cm / 3 4/8"	
593	HMI-SI-802	Iris Scissors 9 cm / 3 4/8"	
594	HMI-SI-803	Iris Scissors 10,5 cm / 4 1/8"	
595	HMI-SI-805	Iris Scissors 9 cm / 3 4/8"	
596	HMI-SI-806	Iris Scissors 10,5 cm / 4 1/8"	
597	HMI-SI-807	Iris Scissors 9 cm / 3 4/8"	
598	HMI-SI-808	Iris Scissors 10,5 cm / 4 1/8"	
599	HMI-SI-809	Iris Scissors Mod. Bonn 9 cm / 3 4/8"	

600	HMI-SI-810	Iris Scissors Mod. Bonn 9 cm / 3 4/8"	
601	HMI-SI-811	Iris Scissors 11,5 cm / 4 4/8"	
602	HMI-SI-812	Iris Scissors Graefe 10 cm / 3 7/8"	
603	HMI-SI-813	Iris Scissors 12,5 cm / 4 7/8"	
604	HMI-SI-814	Iris Scissors 12,5 cm / 4 7/8"	
605	HMI-SI-815	Iris Scissors Standard 11,5 cm / 4 4/8"	
606	HMI-SI-816	Iris Scissors TCGOLD 11,5 cm / 4 4/8"	
607	HMI-SI-817	Iris Scissors Super Cut 11,5 cm / 4 4/8"	



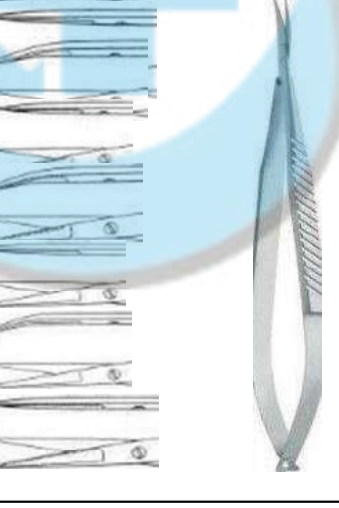

608	HMI-SI-818	Iris Scissors Standard 11,5 cm / 4 4/8"	
609	HMI-SI-819	Iris Scissors TCGOLD 11,5 cm / 4 4/8"	
610	HMI-SI-820	Iris Scissors Super Cut 11,5 cm / 4 4/8"	
611	HMI-SI-821	Iris Scissors Standard 11,5 cm / 4 4/8"	
612	HMI-SI-822	Iris Scissors TCGOLD 11,5 cm / 4 4/8"	
613	HMI-SI-823	Iris Scissors Stevens Standard sharp/sharp 11 cm / 4 3/8"	
614	HMI-SI-824	Iris Scissors Stevens Super Cut sharp/sharp 11 cm / 4 3/8"	
615	HMI-SI-825	Iris Scissors Standard sharp/sharp 11 cm / 4 3/8"	



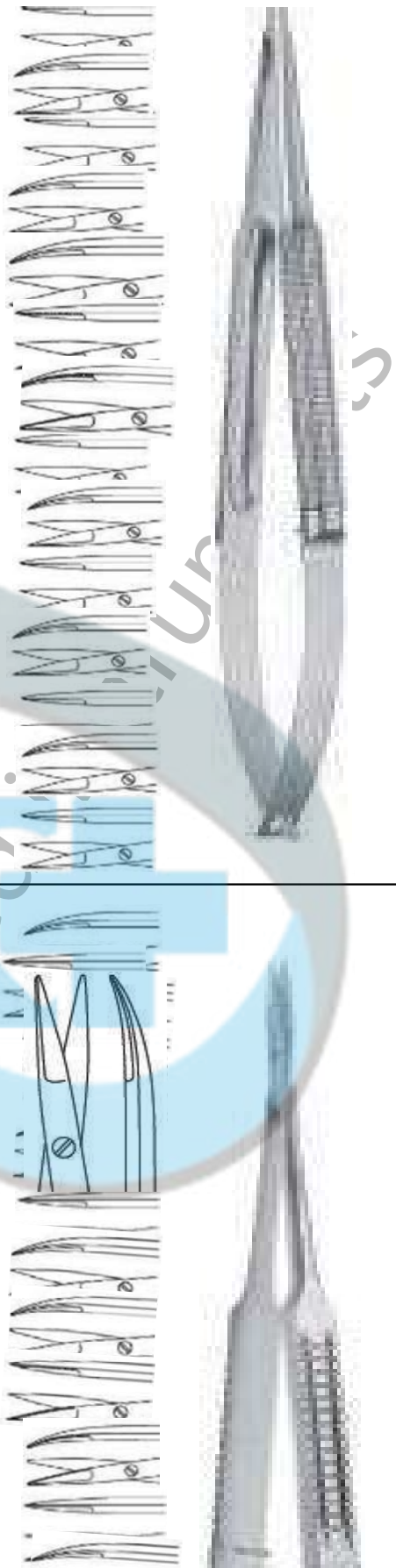

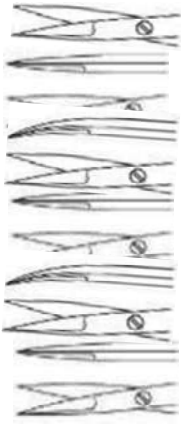

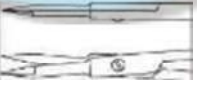

616	HMI-SI-826	Iris Scissors Super Cut sharp/sharp 11 cm / 4 3/8"	
617	HMI-SI-827	Iris Scissors Stevens Standard blunt/blunt 11 cm / 4 3/8"	
618	HMI-SI-828	Iris Scissors Stevens Super Cut blunt/blunt 11 cm / 4 3/8"	
619	HMI-SI-829	Iris Scissors Standard blunt/blunt 11 cm / 4 3/8"	
620	HMI-SI-830	Iris Scissors Super Cut blunt/blunt 11 cm / 4 3/8"	
621	HMI-SI-831	Strabismus Scissors 11,5 cm / 4 4/8"	
622	HMI-SI-832	Strabismus Scissors 11,5 cm / 4 4/8"	
623	HMI-SI-833	Strabismus Scissors Enucleation Scissors 11,5 cm / 4 4/8"	









624	HMI-SI-834	Strabismus Scissors Westcott 11,5 cm / 4 4/8"		
625	HMI-SI-835	Strabismus Scissors Westcott 11,5 cm / 4 4/8"		
626	HMI-SI-836	Micro Scissors 15 cm / 5 7/8" 9 mm A		
627	HMI-SI-837	Micro Scissors 15 cm / 5 7/8" 9 mm D		
628	HMI-SI-838	Micro Scissors 15 cm / 5 7/8" 9 mm A-SB		
629	HMI-SI-839	Micro Scissors 15 cm / 5 7/8" 9 mm D-SB		
630	HMI-SI-840	Micro Scissors 15 cm / 5 7/8" 14 mm A		
631	HMI-SI-841	Micro Scissors 15 cm / 5 7/8" 14 mm D		
632	HMI-SI-842	Micro Scissors 15 cm / 5 7/8" 14 mm A-SB		
633	HMI-SI-843	Micro Scissors 15 cm / 5 7/8" 14 mm D-SB		
634	HMI-SI-844	Micro Scissors 15 cm / 5 7/8" 9 mm A		
635	HMI-SI-845	Micro Scissors 15 cm / 5 7/8" 9 mm D		
636	HMI-SI-846	Micro Scissors 15 cm / 5 7/8" 9 mm A-SB		
637	HMI-SI-847	Micro Scissors 15 cm / 5 7/8" 9 mm D-SB		
638	HMI-SI-848	Micro Scissors 15 cm / 5 7/8" 14 mm A		
639	HMI-SI-849	Micro Scissors 15 cm / 5 7/8" 14 mm D		
640	HMI-SI-850	Micro Scissors 15 cm / 5 7/8" 14 mm A-SB		
641	HMI-SI-851	Micro Scissors 15 cm / 5 7/8" 14 mm D-SB		
642	HMI-SI-852	Micro Scissors St 15 cm / 5 7/8" 10mm A		
643	HMI-SI-853	Micro Scissors St 15 cm / 5 7/8" 10mm A		
644	HMI-SI-854	Micro Scissors Ti 18 cm / 7 1/8" 10mm A		









645	HMI-SI-855	Micro Scissors Ti 18 cm / 7 1/8" 10mm A
646	HMI-SI-856	Micro Scissors St 18 cm / 7 1/8" 10mm A
647	HMI-SI-857	Micro Scissors St 18 cm / 7 1/8" 10mm A
648	HMI-SI-858	Micro Scissors St 18 cm / 7 1/8" 10mm D
649	HMI-SI-859	Micro Scissors St 18 cm / 7 1/8" 10mm A-SB
650	HMI-SI-860	Micro Scissors St 21 cm / 8 2/8" 10mm D-SB
651	HMI-SI-861	Micro Scissors Ti 18 cm / 7 1/8" 10mm A
652	HMI-SI-862	Micro Scissors Ti 18 cm / 7 1/8" 10mm A
653	HMI-SI-863	Micro Scissors St 21 cm / 8 2/8" 10mm A
654	HMI-SI-864	Micro Scissors St 21 cm / 8 2/8" 10mm A
655	HMI-SI-865	Micro Scissors Ti 21 cm / 8 2/8" 10mm A
656	HMI-SI-866	Micro Scissors Ti 21 cm / 8 2/8" 10mm A
657	HMI-SI-867	Micro Scissors St 23 cm / 9" 10mm A
658	HMI-SI-868	Micro Scissors St 23 cm / 9" 10mm A
659	HMI-SI-869	Micro Scissors St 15 cm / 5 7/8" 10mm A
660	HMI-SI-870	Micro Scissors St 15 cm / 5 7/8" 10mm A
661	HMI-SI-871	Micro Scissors Ti 18 cm / 7 1/8" 10mm A
662	HMI-SI-872	Micro Scissors Ti 18 cm / 7 1/8" 10mm A
663	HMI-SI-873	Micro Scissors St 18 cm / 7 1/8" 10mm A
664	HMI-SI-874	Micro Scissors St 18 cm / 7 1/8" 10mm A
665	HMI-SI-875	Micro Scissors St 18 cm / 7 1/8" 10mm D
666	HMI-SI-876	Micro Scissors St 18 cm / 7 1/8" 10mm A-SB
667	HMI-SI-877	Micro Scissors St 21 cm / 8 2/8" 10mm D-SB
668	HMI-SI-878	Micro Scissors Ti 18 cm / 7 1/8" 10mm A
669	HMI-SI-879	Micro Scissors Ti 18 cm / 7 1/8" 10mm A























670	HMI-SI-880	Micro Scissors St 21 cm / 8 2/8" 10mm A	 
671	HMI-SI-881	Micro Scissors St 21 cm / 8 2/8" 10mm A	
672	HMI-SI-882	Micro Scissors Ti 21 cm / 8 2/8" 10mm A	
673	HMI-SI-883	Micro Scissors Ti 21 cm / 8 2/8" 10mm A	
674	HMI-SI-884	Micro Scissors St 23 cm / 9" 10mm A	
675	HMI-SI-885	Micro Scissors St 23 cm / 9" 10mm A	
676	HMI-SI-886	Micro Scissors Jacobson 20,5 cm / 8 1/8"	
677	HMI-SI-887	Micro Scissors Jacobson 20 cm / 7 7/8"	
678	HMI-SI-888	Micro Scissors Jacobson 20,5 cm / 8 1/8"	
679	HMI-SI-889	Micro Scissors Jacobson 20 cm / 7 7/8"	
680	HMI-SI-890	Micro Scissors 20 cm / 7 7/8"	 
681	HMI-SI-891	Micro Scissors 18 cm / 7 1/8"	











682	HMI-SI-892	Micro Scissors 19 cm / 7 4/8"	
683	HMI-SI-893	Micro Scissors bent upwards 18,5 cm / 7 2/8"	
684	HMI-SI-894	Micro Scissors bent downwards 18,5 cm / 7 2/8"	
685	HMI-SI-895	Micro Scissors, Micro Dissecting Scissors 12 cm / 4 6/8"	
686	HMI-SI-896	Micro Scissors, Micro Dissecting Scissors 12 cm / 4 6/8"	
687	HMI-SI-897	Micro Scissors for veins Biemer 12 cm / 4 6/8"	
688	HMI-SI-898	Micro Scissors, Micro Dissecting Scissors 10 cm / 3 7/8"	
689	HMI-SI-899	Micro Scissors, Micro Dissecting Scissors 9,5 cm / 3 6/8"	









690	HMI-SI-900	Micro Scissors Jaboma for Cleft Palate 18 cm / 7 1/8"	
691	HMI-SI-901	Micro Scissors Jaboma for Cleft Palate 18 cm / 7 1/8"	
692	HMI-SI-902	Micro Scissors Jaboma for Cleft Palate 18 cm / 7 1/8"	
693	HMI-SI-903	Micro Scissors 19 cm / 7 4/8"	
694	HMI-SI-904	Micro Scissors 15,5 cm / 6 1/8"	
695	HMI-SI-905	Micro Scissors 15,5 cm / 6 1/8"	
696	HMI-SI-906	Enterotomy Scissors 21,5 cm / 8 4/8"	
697	HMI-SI-907	Enterotomy Scissors 21,5 cm / 8 4/8"	

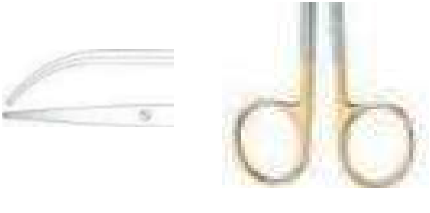

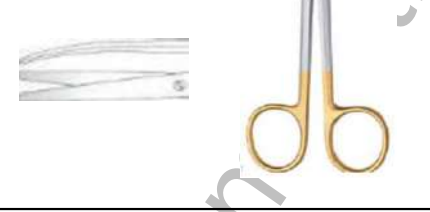





698	HMI-SI-908	Enterotomy Scissors Rectal Scissors 32,5 cm / 12 6/8"	
699	HMI-SI-909	Stitch Scissors Salyer for Cleft Palate 9,5 cm / 3 6/8"	
700	HMI-SI-910	Stitch Scissors Salyer for Cleft Palate 10 cm / 3 7/8"	
701	HMI-SI-911	Stitch Scissors Kaye both cutting edges serrated 11 cm / 4 3/8"	
702	HMI-SI-912	Stitch Scissors Northbent 13 cm / 5 1/8"	
703	HMI-SI-913	Stitch Scissors Spencer 9 cm / 3 4/8"	
704	HMI-SI-914	Stitch Scissors Spencer 13 cm / 5 1/8"	
705	HMI-SI-915	Stitch Scissors Buck 14,5 cm / 5 6/8"	









706	HMI-SI-916	Stitch Scissors Buck 18 cm / 7 1/8"	 
707	HMI-SI-917	Stitch Scissors Littauer 14 cm / 5 4/8"	
708	HMI-SI-918	Stitch Scissors Eiselsberg 12 cm / 4 6/8"	
709	HMI-SI-919	Wire Cutting Scissors Universal Standard 12 cm / 4 6/8"	
710	HMI-SI-920	Wire Cutting Scissors Universal TCGOLD 12 cm / 4 6/8"	
711	HMI-SI-921	Wire Cutting Scissors Beebee 10 cm / 3 7/8"	
712	HMI-SI-922	Wire Cutting Scissors Beebee 10 cm / 3 7/8"	
713	HMI-SI-923	Wire Cutting Scissors Beebee one toothed cutting edge 12 cm / 4 6/8"	 

714	HMI-SI-924	Wire Cutting Scissors Beebee one toothed cutting edge 12 cm / 4 6/8"	
715	HMI-SI-925	Dissecting Scissors Lillehei-Potts 18 cm / 7 1/8"	
716	HMI-SI-926	Dissecting Scissors Potts-De Martell 20°	
717	HMI-SI-927	Dissecting Scissors Potts-De Martell 50°	
718	HMI-SI-928	Dissecting Scissors Potts-De Martell 90°	
719	HMI-SI-929	Ligature Scissors or synthetic suture material, one toothed cutting edge 11,5 cm / 4 4/8"	
720	HMI-SI-930	Ligature Scissors or synthetic suture material, one toothed cutting edge 14,5 cm / 5 3/4"	
721	HMI-SI-931	Ligature Scissors or synthetic suture material, one toothed cutting edge 18 cm / 7"	
722	HMI-SI-932	Ligature Scissors or synthetic suture material, one toothed cutting edge 20,5 cm / 8"	
723	HMI-SI-933	Ligature Scissors or synthetic suture material, one toothed cutting edge 23 cm / 9"	
724	HMI-SI-934	Ligature Scissors or synthetic suture material, one toothed cutting edge 25 cm / 9 3/4"	

725	HMI-SI-935	Ligature Scissors or synthetic suture material, one toothed cutting edge 30 cm / 11 6/8"	
726	HMI-SI-936	Ligature Scissors for synthetic suture material, one toothed cutting edge 14,5 cm / 5 3/4"	   
727	HMI-SI-937	Ligature Scissors for synthetic suture material, one toothed cutting edge 17 cm / 6 3/4"	
728	HMI-SI-938	Ligature Scissors for synthetic suture material, one toothed cutting edge 23 cm / 9"	
TCC-BlackLine Scissors			
729	HMI-SI-939	TCC-BlackLine Scissors Tönnis-Adson TCC-BlackLine 14,5 cm / 5 6/8"	  
730	HMI-SI-940	TCC-BlackLine Scissors Tönnis-Adson TCC-BlackLine 18 cm / 7 1/8"	
Dissecting Scissors, Operating Scissors			
731	HMI-SI-941	Dissecting Scissors, Operating Scissors Metzenbaum-Thorek 20 cm / 7 7/8"	  
732	HMI-SI-942	Dissecting Scissors, Operating Scissors Metzenbaum-Thorek 23 cm / 9"	

733	HMI-SI-943	Dissecting Scissors, Operating Scissors Metzenbaum-Thorek 28 cm / 11"	
734	HMI-SI-944	Dissecting Scissors, Operating Scissors Lexer 21 cm / 8 2/8"	
735	HMI-SI-945	Dissecting Scissors, Operating Scissors Lexer 21 cm / 8 2/8"	
736	HMI-SI-946	Dissecting Scissors, Operating Scissors Mayo Lexer 16 cm / 6 2/8"	
Delicate Dissecting Scissors			
737	HMI-SI-947	Delicate Dissecting Scissors Metzenbaum-Fino 26 cm / 10 2/8"	
738	HMI-SI-948	Delicate Dissecting Scissors Metzenbaum-Fino 28,5 cm / 11 2/8"	
739	HMI-SI-949	Delicate Dissecting Scissors Metzenbaum-Fino 18 cm / 7 1/8"	
740	HMI-SI-950	Delicate Dissecting Scissors Metzenbaum-Fino 20 cm / 7 7/8"	

741	HMI-SI-951	Delicate Dissecting Scissors Metzenbaum-Fino 23 cm / 9"	
742	HMI-SI-952	Delicate Dissecting Scissors Metzenbaum-Lahey 14,5 cm / 5 6/8"	
743	HMI-SI-953	Delicate Dissecting Scissors Toennis-Adson TCGOLD 17,5 cm / 6 7/8"	
744	HMI-SI-954	Delicate Dissecting Scissors Toennis-Adson AQUILA 17,5 cm / 6 7/8"	
745	HMI-SI-955	Delicate Dissecting Scissors Toennis-Adson TCC BlackLine 17,5 cm / 6 7/8"	
746	HMI-SI-956	Delicate Dissecting Scissors Metzenbaum-Fino 20,5 cm / 8 1/8"	
747	HMI-SI-957	Delicate Dissecting Scissors Metzenbaum-Fino 23 cm / 9"	
Face-lift Scissors			
748	HMI-SI-958	Face-lift Scissors Gorney one toothed cutting edge 20 cm / 7 7/8"	

749	HMI-SI-959	Face-lift Scissors Gorney one toothed cutting edge 23 cm / 9"	
750	HMI-SI-960	Face-lift Scissors Rees one toothed cutting edge 17 cm / 6 6/8"	
Uterine Scissors			
751	HMI-SI-961	Uterine Scissors TCGOLD 22 cm / 8 5/8"	
752	HMI-SI-962	Uterine Scissors AQUILA 22 cm / 8 5/8"	
753	HMI-SI-963	Uterine Scissors TCC BlackLine 22 cm / 8 5/8"	
754	HMI-SI-964	Uterine Scissors TCGOLD 23 cm / 9"	
755	HMI-SI-965	Uterine Scissors AQUILA 23 cm / 9"	
756	HMI-SI-966	Uterine Scissors TCC BlackLine 23 cm / 9"	
Angled Scissors			







757	HMI-SI-967	Angled Scissors De Bakey 19 cm / 7 4/8"	
758	HMI-SI-968	Angled Scissors De Bakey 18,5 cm / 7 2/8"	
759	HMI-SI-969	Angled Scissors De Bakey 18 cm / 7 1/8"	
760	HMI-SI-970	Angled Scissors De Bakey 23 cm / 9"	
761	HMI-SI-971	Angled Scissors De Bakey 23 cm / 9"	
762	HMI-SI-972	Angled Scissors De Bakey 22 cm / 8 5/8"	

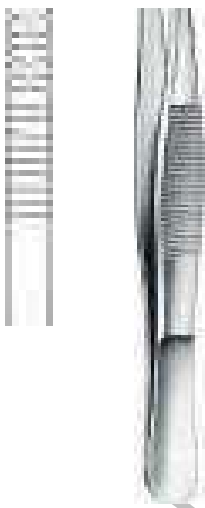

Dissecting Scissors, Wire Cutting Scissors







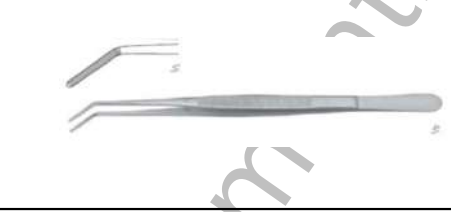
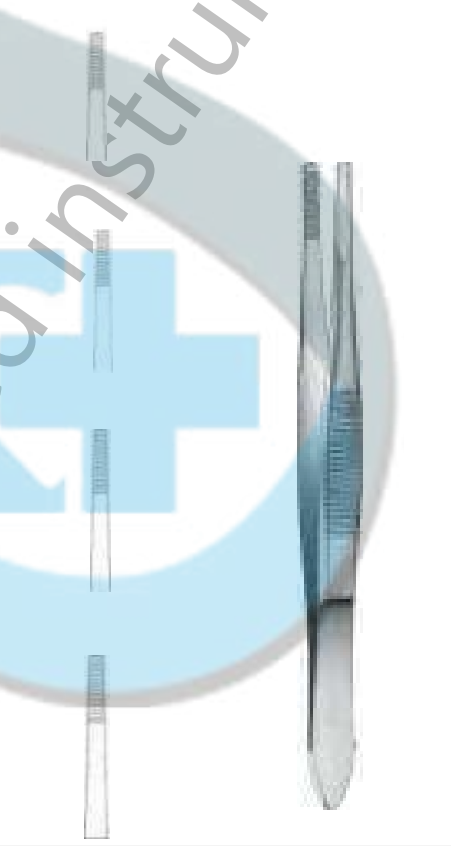

763	HMI-SI-973	Dissecting Scissors, Wire Cutting Scissors Ragnell 12,5 cm / 4 7/8"	
764	HMI-SI-974	Dissecting Scissors, Wire Cutting Scissors Ragnell Wire cutting scissors	







Dissecting Forceps





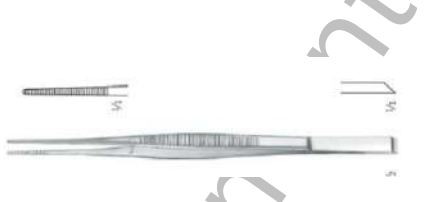
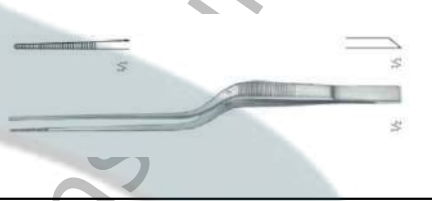
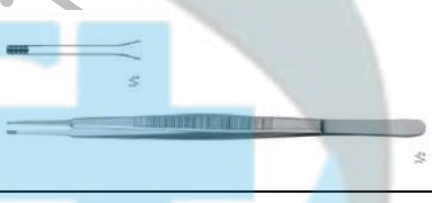



765	HMI-SI-1000	Dissecting Forceps standard pattern 10,5 cm / 4 1/8"	
766	HMI-SI-1001	Dissecting Forceps standard pattern 11,5 cm / 4 4/8"	
767	HMI-SI-1002	Dissecting Forceps standard pattern 13 cm / 5 1/8"	
768	HMI-SI-1003	Dissecting Forceps standard pattern 14,5 cm / 5 6/8"	
769	HMI-SI-1004	Dissecting Forceps standard pattern 16 cm / 6 2/8"	
770	HMI-SI-1005	Dissecting Forceps standard pattern 18 cm / 7 1/8"	
771	HMI-SI-1006	Dissecting Forceps standard pattern 20 cm / 7 7/8"	
772	HMI-SI-1007	Dissecting Forceps standard pattern 23 cm / 9"	
773	HMI-SI-1008	Dissecting Forceps standard pattern 25 cm / 9 7/8"	
774	HMI-SI-1009	Dissecting Forceps standard pattern 30,5 cm / 12"	
775	HMI-SI-1010	Dissecting Forceps medium width 12 cm / 4 6/8"	
776	HMI-SI-1011	Dissecting Forceps medium width 13 cm / 5 1/8"	









777	HMI-SI-1012	Dissecting Forceps medium width 14,5 cm / 5 6/8"	
778	HMI-SI-1013	Dissecting Forceps medium width 16 cm / 6 2/8"	
779	HMI-SI-1014	Dissecting Forceps medium width 18 cm / 7 1/8"	
780	HMI-SI-1015	Dissecting Forceps medium width 20 cm / 7 7/8"	
781	HMI-SI-1016	Dissecting Forceps medium width 23 cm / 9"	
782	HMI-SI-1017	Dissecting Forceps medium width 25 cm / 9 7/8"	
783	HMI-SI-1018	Dissecting Forceps medium width 30 cm / 11 6/8"	
784	HMI-SI-1019	Dissecting Forceps 13 cm / 5 1/8"	
785	HMI-SI-1020	Dissecting Forceps 14,5 cm / 5 6/8"	
786	HMI-SI-1021	Dissecting Forceps 13 cm / 5 1/8"	
787	HMI-SI-1022	Dissecting Forceps 14,5 cm / 5 6/8"	
788	HMI-SI-1023	Dissecting Forceps Stille 15 cm / 5 7/8"	
789	HMI-SI-1024	Dissecting Forceps Bonney 17 cm / 6 6/8"	









790	HMI-SI-1025	Dissecting Forceps 18,5 cm / 7 2/8"	
791	HMI-SI-1026	Dissecting Forceps Brophy 20 cm / 7 7/8"	
792	HMI-SI-1027	Dissecting Forceps 20 cm / 7 7/8"	
793	HMI-SI-1028	Dissecting Forceps Schweden-Modell 13 cm / 5 1/8"	
794	HMI-SI-1029	Dissecting Forceps Schweden-Modell 15 cm / 5 7/8"	
795	HMI-SI-1030	Dissecting Forceps Schweden-Modell 17 cm / 6 7/8"	
796	HMI-SI-1031	Dissecting Forceps Schweden-Modell 20 cm / 7 7/8"	
797	HMI-SI-1032	Dissecting Forceps Mini-Adson 12 cm / 4 6/8"	

798	HMI-SI-1033	Dissecting Forceps Adson 12 cm / 4 6/8"	
799	HMI-SI-1034	Dissecting Forceps Adson 15 cm / 5 7/8"	
800	HMI-SI-1035	Dissecting Forceps McIndoe 15 cm / 5 7/8"	
801	HMI-SI-1036	Dissecting Forceps Waugh 20 cm / 7 7/8"	
802	HMI-SI-1037	Dissecting Forceps Semken 12,5 cm / 4 7/8"	
803	HMI-SI-1038	Dissecting Forceps Semken 15 cm / 5 7/8"	
804	HMI-SI-1039	Dissecting Forceps 15,5 cm / 6 1/8" 0,6 mm	
805	HMI-SI-1040	Dissecting Forceps 15,5 cm / 6 1/8" 0,8 mm	

806	HMI-SI-1041	Dissecting Forceps 15,5 cm / 6 1/8" 1,0 mm	
807	HMI-SI-1042	Dissecting Forceps Taylor 17 cm / 6 6/8"	
808	HMI-SI-1043	Dissecting Forceps Taylor with dissector end 17,5 cm / 6 7/8"	
809	HMI-SI-1044	Dissecting Forceps Taylor with dissector end 18,5 cm / 7 2/8"	
810	HMI-SI-1045	Dissecting Forceps 17,5 cm / 6 7/8"	
811	HMI-SI-1046	Dissecting Forceps Gerald 17,5 cm / 6 7/8"	
812	HMI-SI-1047	Dissecting Forceps Gerald 17 cm / 6 6/8"	
813	HMI-SI-1048	Dissecting Forceps Cushing 17,5 cm / 6 7/8"	





814	HMI-SI-1049	Dissecting Forceps Cushing 17 cm / 6 6/8"	
815	HMI-SI-1050	Dissecting Forceps Potts-Smith 18 cm / 7 1/8"	    
816	HMI-SI-1051	Dissecting Forceps Potts-Smith 21 cm / 8 2/8"	
817	HMI-SI-1052	Dissecting Forceps Potts-Smith 25 cm / 9 7/8"	
818	HMI-SI-1053	Dissecting Forceps Potts-Smith 30 cm / 11 6/8"	
Tissue Forceps, Dissecting Forceps			
TCGOLD			
819	HMI-SI-1054	Tissue Forceps, Dissecting Forceps Bonney TCGOLD 17,5 cm / 6 7/8"	
820	HMI-SI-1055	Tissue Forceps, Dissecting Forceps Gerald TCGOLD 17,5 cm / 6 7/8"	
821	HMI-SI-1056	Tissue Forceps, Dissecting Forceps Gillies TCGOLD 15,5 cm / 6 1/8"	



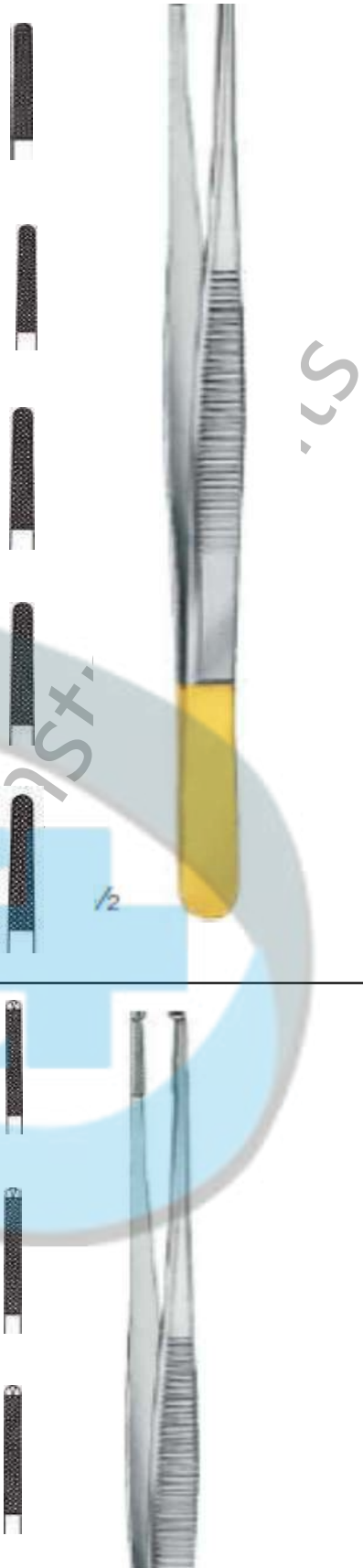

822	HMI-SI-1057	Tissue Forceps, Dissecting Forceps McIndoe TCGOLD 15 cm / 5 7/8"	
823	HMI-SI-1058	Tissue Forceps, Dissecting Forceps Semken TCGOLD 15,5 cm / 6 1/8"	
824	HMI-SI-1059	Tissue Forceps, Dissecting Forceps Semken 17,5 cm / 6 7/8"	
825	HMI-SI-1060	Tissue Forceps, Dissecting Forceps Semken TCGOLD 15,5 cm / 6 1/8"	
826	HMI-SI-1061	Tissue Forceps, Dissecting Forceps Semken TCGOLD 17,5 cm / 6 7/8"	
827	HMI-SI-1062	Tissue Forceps, Dissecting Forceps Adson-Brown TCGOLD 12 cm / 4 6/8"	
828	HMI-SI-1063	Tissue Forceps, Dissecting Forceps Adson TCGOLD 12 cm / 4 6/8"	
829	HMI-SI-1064	Tissue Forceps, Dissecting Forceps Adson TCGOLD 15 cm / 5 7/8"	

830	HMI-SI-1065	Tissue Forceps, Dissecting Forceps Adson normal proyle TCGOLD 12 cm / 4 6/8"	
831	HMI-SI-1066	Tissue Forceps, Dissecting Forceps Adson normal proyle TCGOLD 15 cm / 5 7/8"	
832	HMI-SI-1067	Tissue Forceps, Dissecting Forceps Adson normal proyle TCGOLD 12 cm / 4 6/8"	
833	HMI-SI-1068	Tissue Forceps, Dissecting Forceps Adson normal proyle TCGOLD 15 cm / 5 7/8"	
834	HMI-SI-1069	Dissecting Forceps TCGOLD Cushing 17,5 cm / 6 7/8"	
835	HMI-SI-1070	Dissecting Forceps TCGOLD Cushing 17 cm / 6 6/8"	
836	HMI-SI-1071	Dissecting Forceps TCGOLD Cushing-Taylor 18,5 cm / 7 2/8"	
837	HMI-SI-1072	Dissecting Forceps TCGOLD Potts-Smith normal proyle 14,5 cm / 5 6/8"	

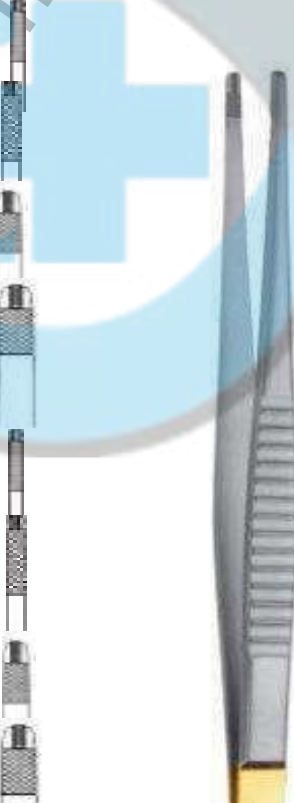
838	HMI-SI-1073	Dissecting Forceps TCGOLD Potts-Smith normal proyle 16 cm / 6 2/8"
839	HMI-SI-1074	Dissecting Forceps TCGOLD Potts-Smith normal proyle 18,5 cm / 7 2/8"
840	HMI-SI-1075	Dissecting Forceps TCGOLD Potts-Smith normal proyle 20 cm / 7 7/8"
841	HMI-SI-1076	Dissecting Forceps TCGOLD Potts-Smith normal proyle 23 cm / 9"
842	HMI-SI-1077	Dissecting Forceps TCGOLD Potts-Smith normal proyle 25 cm / 9 7/8"
843	HMI-SI-1078	Dissecting Forceps TCGOLD Oehler 14,5 cm / 5 6/8"
844	HMI-SI-1079	Dissecting Forceps TCGOLD Oehler 16 cm / 6 2/8"
845	HMI-SI-1080	Dissecting Forceps TCGOLD Oehler 18 cm / 7 1/8"



846	HMI-SI-1081	Dissecting Forceps TCGOLD Oehler 20 cm / 7 7/8"	
847	HMI-SI-1082	Dissecting Forceps TCGOLD Oehler 25 cm / 9 7/8"	
848	HMI-SI-1083	Dissecting Forceps Wangenstein 15 cm / 5 7/8"	
849	HMI-SI-1084	Dissecting Forceps Wangenstein 23 cm / 9"	
850	HMI-SI-1085	Dissecting Forceps TCGOLD DeBakey mini proyle 16 cm / 6 2/8" 2,0 mm	
851	HMI-SI-1086	Dissecting Forceps TCGOLD DeBakey mini proyle 16 cm / 6 2/8" 1,5 mm	
852	HMI-SI-1087	Dissecting Forceps TCGOLD DeBakey normal proyle 16 cm / 6 2/8" 2,7 mm	
853	HMI-SI-1088	Dissecting Forceps TCGOLD DeBakey normal proyle 16 cm / 6 2/8" 3,5 mm	
854	HMI-SI-1089	Dissecting Forceps TCGOLD DeBakey mini proyle 20 cm / 7 7/8" 2,0 mm	
855	HMI-SI-1090	Dissecting Forceps TCGOLD DeBakey mini proyle 20 cm / 7 7/8" 1,5 mm	
856	HMI-SI-1091	Dissecting Forceps TCGOLD DeBakey normal proyle 20 cm / 7 7/8" 2,7 mm	
857	HMI-SI-1092	Dissecting Forceps TCGOLD DeBakey normal proyle 20 cm / 7 7/8" 3,5 mm	

858	HMI-SI-1093	Dissecting Forceps TCGOLD DeBakey mini proyle 24,5 cm / 9 5/8" 2,0 mm	
859	HMI-SI-1094	Dissecting Forceps TCGOLD DeBakey mini proyle 24,5 cm / 9 5/8" 1,5 mm	
860	HMI-SI-1095	Dissecting Forceps TCGOLD DeBakey normal proyle 24,5 cm / 9 5/8" 2,7 mm	
861	HMI-SI-1096	Dissecting Forceps TCGOLD DeBakey normal proyle 24,5 cm / 9 5/8" 3,5 mm	
862	HMI-SI-1097	Dissecting Forceps TCGOLD Jaboma 18 cm / 7 1/8"	
863	HMI-SI-1098	Dissecting Forceps TCGOLD Jaboma 18 cm / 7 1/8"	
864	HMI-SI-1099	Dissecting Forceps TCGOLD Jaboma 18 cm / 7 1/8"	
Dissecting Forceps, Atraumatic Dissecting Forceps			
865	HMI-SI-1100	Dissecting Forceps, Atraumatic Dissecting Forceps DeBakey 16 cm / 6 2/8" 1,0 mm	
866	HMI-SI-1101	Dissecting Forceps, Atraumatic Dissecting Forceps DeBakey 16 cm / 6 2/8" 1,5 mm	
867	HMI-SI-1102	Dissecting Forceps, Atraumatic Dissecting Forceps DeBakey 16 cm / 6 2/8" 1,8 mm	
868	HMI-SI-1103	Dissecting Forceps, Atraumatic Dissecting Forceps DeBakey 16 cm / 6 2/8" 2,8 mm	

869	HMI-SI-1104	Dissecting Forceps, Atraumatic Dissecting Forceps DeBakey 20,5 cm / 8 1/8" 1,0 mm
870	HMI-SI-1105	Dissecting Forceps, Atraumatic Dissecting Forceps DeBakey 20,5 cm / 8 1/8" 1,5 mm
871	HMI-SI-1106	Dissecting Forceps, Atraumatic Dissecting Forceps DeBakey 20,5 cm / 8 1/8" 1,8 mm
872	HMI-SI-1107	Dissecting Forceps, Atraumatic Dissecting Forceps DeBakey 20,5 cm / 8 1/8" 2,8 mm
873	HMI-SI-1108	Dissecting Forceps, Atraumatic Dissecting Forceps DeBakey 24,5 cm / 9 5/8" 1,0 mm
874	HMI-SI-1109	Dissecting Forceps, Atraumatic Dissecting Forceps DeBakey 24,5 cm / 9 5/8" 1,5 mm
875	HMI-SI-1110	Dissecting Forceps, Atraumatic Dissecting Forceps DeBakey 24,5 cm / 9 5/8" 1,8 mm
876	HMI-SI-1111	Dissecting Forceps, Atraumatic Dissecting Forceps DeBakey 24,5 cm / 9 5/8" 2,8 mm
877	HMI-SI-1112	Dissecting Forceps, Atraumatic Dissecting Forceps Gerald St 18 cm / 7 1/8" 1,2 mm
878	HMI-SI-1113	Dissecting Forceps, Atraumatic Dissecting Forceps Gerald St 18 cm / 7 1/8" 1,0 x 0,5 mm 1,2 mm
879	HMI-SI-1114	Dissecting Forceps, Atraumatic Dissecting Forceps Gerald St 18 cm / 7 1/8" 1,0 mm 1,2 mm
880	HMI-SI-1115	Dissecting Forceps, Atraumatic Dissecting Forceps Gerald Ti 18 cm / 7 1/8" 1,2 mm







881	HMI-SI-1116	Dissecting Forceps, Atraumatic Dissecting Forceps Gerald Ti 18 cm / 7 1/8" 1,0 x 0,5 mm 1,2 mm
882	HMI-SI-1117	Dissecting Forceps, Atraumatic Dissecting Forceps Gerald Ti 18 cm / 7 1/8" 1,0 mm 1,2 mm
883	HMI-SI-1118	Dissecting Forceps, Atraumatic Dissecting Forceps Gerald St 20 cm / 7 7/8" 1,2 mm
884	HMI-SI-1119	Dissecting Forceps, Atraumatic Dissecting Forceps Gerald St 20 cm / 7 7/8" 1,0 x 0,5 mm 1,2 mm
885	HMI-SI-1120	Dissecting Forceps, Atraumatic Dissecting Forceps Gerald St 20 cm / 7 7/8" 1,0 mm 1,2 mm
886	HMI-SI-1121	Dissecting Forceps, Atraumatic Dissecting Forceps Gerald Ti 20 cm / 7 7/8" 1,2 mm
887	HMI-SI-1122	Dissecting Forceps, Atraumatic Dissecting Forceps Gerald Ti 20 cm / 7 7/8" 1,0 x 0,5 mm 1,2 mm
888	HMI-SI-1123	Dissecting Forceps, Atraumatic Dissecting Forceps Gerald Ti 20 cm / 7 7/8" 1,0 mm 1,2 mm



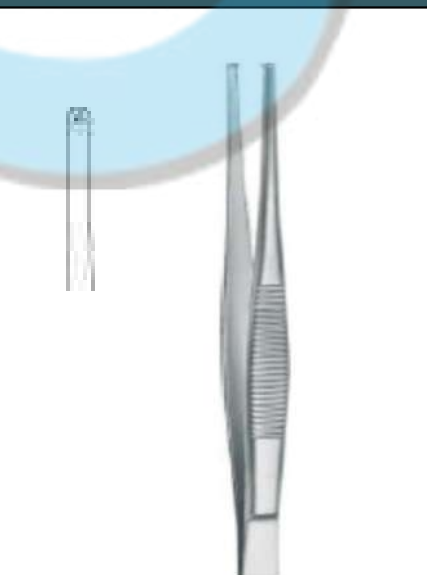







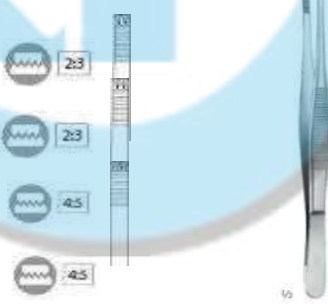

Tissue Forceps









889	HMI-SI-1124	Tissue Forceps standard pattern 10,5 cm / 4 1/8"
890	HMI-SI-1125	Tissue Forceps standard pattern 12 cm / 4 6/8"
891	HMI-SI-1126	Tissue Forceps standard pattern 13 cm / 5 1/8"
892	HMI-SI-1127	Tissue Forceps standard pattern 14,5 cm / 5 6/8"
893	HMI-SI-1128	Tissue Forceps standard pattern 16 cm / 6 2/8"
894	HMI-SI-1129	Tissue Forceps standard pattern 18 cm / 7 1/8"
895	HMI-SI-1130	Tissue Forceps standard pattern 20,5 cm / 8 1/8"
896	HMI-SI-1131	Tissue Forceps standard pattern 23 cm / 9"











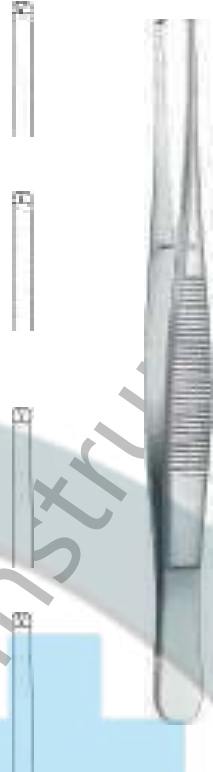



897	HMI-SI-1132	Tissue Forceps standard pattern 25 cm / 9 7/8"	
898	HMI-SI-1133	Tissue Forceps standard pattern 30,5 cm / 12"	
899	HMI-SI-1134	Tissue Forceps 12 cm / 4 6/8"	
900	HMI-SI-1135	Tissue Forceps 13 cm / 5 1/8"	
901	HMI-SI-1136	Tissue Forceps 14,5 cm / 5 6/8"	
902	HMI-SI-1137	Tissue Forceps 16 cm / 6 2/8"	
903	HMI-SI-1138	Tissue Forceps 17 cm / 6 6/8"	
904	HMI-SI-1139	Tissue Forceps 18 cm / 7 1/8"	
905	HMI-SI-1140	Tissue Forceps 20,5 cm / 8 1/8"	
906	HMI-SI-1141	Tissue Forceps 25 cm / 9 7/8"	
907	HMI-SI-1142	Tissue Forceps 14,5 cm / 5 6/8"	
908	HMI-SI-1143	Tissue Forceps 16 cm / 6 2/8"	
909	HMI-SI-1144	Tissue Forceps 20 cm / 7 7/8"	
910	HMI-SI-1145	Tissue Forceps 14,5 cm / 5 6/8"	
911	HMI-SI-1146	Tissue Forceps 16 cm / 6 2/8"	
912	HMI-SI-1147	Tissue Forceps medium 13 cm / 5 1/8"	
913	HMI-SI-1148	Tissue Forceps medium 14,5 cm / 5 6/8"	
914	HMI-SI-1149	Tissue Forceps medium 16 cm / 6 2/8"	
915	HMI-SI-1150	Tissue Forceps medium 18 cm / 7 1/8"	
916	HMI-SI-1151	Tissue Forceps medium 20,5 cm / 8 1/8"	
917	HMI-SI-1152	Tissue Forceps medium 23 cm / 9"	
918	HMI-SI-1153	Tissue Forceps medium 25 cm / 9 7/8"	
919	HMI-SI-1154	Tissue Forceps medium 30 cm / 11 6/8"	











920	HMI-SI-1155	Tissue Forceps 14,5 cm / 5 6/8"	
921	HMI-SI-1156	Tissue Forceps 13 cm / 5 1/8"	
922	HMI-SI-1157	Tissue Forceps 14,5 cm / 5 6/8"	
923	HMI-SI-1158	Tissue Forceps Stille 15 cm / 5 7/8"	
924	HMI-SI-1158(a)	Tissue Forceps Stille 15 cm / 5 7/8"	
925	HMI-SI-1159	Tissue Forceps Adlerkreutz 15,5 cm / 6 1/8"	
926	HMI-SI-1160	Tissue Forceps Adlerkreutz 20,5 cm / 8 1/8"	
927	HMI-SI-1161	Tissue Forceps Adlerkreutz 15,5 cm / 6 1/8"	
928	HMI-SI-1162	Tissue Forceps Adlerkreutz 20 cm / 7 7/8"	
929	HMI-SI-1163	Tissue Forceps Adlerkreutz 25 cm / 9 7/8"	
930	HMI-SI-1164	Tissue Forceps Adson 12 cm / 4 6/8"	







931	HMI-SI-1165	Tissue Forceps Adson 15 cm / 5 7/8"	
932	HMI-SI-1166	Tissue Forceps Gillies 15,5 cm / 6 1/8"	
933	HMI-SI-1167	Tissue Forceps Waugh 20 cm / 7 7/8"	
934	HMI-SI-1168	Tissue Forceps Waugh 25 cm / 9 7/8"	
935	HMI-SI-1169	Tissue Forceps Semken 12,5 cm / 4 7/8"	
936	HMI-SI-1170	Tissue Forceps Semken 15 cm / 5 7/8"	
Tissue Forceps, Micro Forceps			
937	HMI-SI-1171	Tissue Forceps, Micro Forceps Brophy 20 cm / 7 7/8"	
938	HMI-SI-1172	Tissue Forceps, Micro Forceps Brophy 15,5 cm / 6 1/8" 0,6 mm	



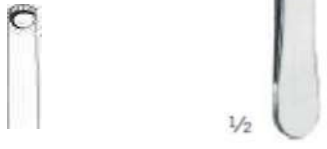





939	HMI-SI-1173	Tissue Forceps, Micro Forceps Brophy 15,5 cm / 6 1/8" 0,8 mm	
940	HMI-SI-1174	Tissue Forceps, Micro Forceps Brophy 15,5 cm / 6 1/8" 1,0 mm	
941	HMI-SI-1175	Tissue Forceps, Micro Forceps Taylor 17,5 cm / 6 7/8"	
942	HMI-SI-1176	Tissue Forceps, Micro Forceps Taylor with dissector end 17 cm / 6 6/8"	
943	HMI-SI-1177	Tissue Forceps, Micro Forceps Taylor with dissector end 18,5 cm / 7 2/8"	
944	HMI-SI-1178	Tissue Forceps Gerald 17,5 cm / 6 7/8"	
945	HMI-SI-1179	Tissue Forceps Gerald 23 cm / 9"	
946	HMI-SI-1180	Tissue Forceps Gerald 17 cm / 6 6/8"	

947	HMI-SI-1181	Tissue Forceps Cushing 18 cm / 7 1/8"	
948	HMI-SI-1182	Tissue Forceps Potts-Smith 18 cm / 7 1/8"	
949	HMI-SI-1183	Tissue Forceps Potts-Smith 21 cm / 8 2/8"	
950	HMI-SI-1184	Tissue Forceps Potts-Smith 25 cm / 9 7/8"	
951	HMI-SI-1185	Tissue Forceps Potts-Smith 30 cm / 11 6/8"	
952	HMI-SI-1186	Dissecting Forceps, Tissue Forceps Adson-Brown 12 cm / 4 6/8"	
953	HMI-SI-1187	Dissecting Forceps, Tissue Forceps Mini-Adson 12 cm / 4 6/8"	
954	HMI-SI-1188	Dissecting Forceps, Tissue Forceps Mini-Adson 12 cm / 4 6/8"	

955	HMI-SI-1189	Dissecting Forceps, Tissue Forceps Mikro-Adson 12 cm / 4 6/8"	
956	HMI-SI-1190	Dissecting Forceps, Tissue Forceps Mikro-Adson 15 cm / 5 7/8"	
957	HMI-SI-1192	Dissecting Forceps, Tissue Forceps Mikro-Adson 12 cm / 4 6/8"	
958	HMI-SI-1193	Dissecting Forceps, Tissue Forceps Mikro-Adson 15 cm / 5 7/8"	
959	HMI-SI-1194	Dissecting Forceps, Tissue Forceps very fine teeth 10,5 cm / 4 1/8"	
Jeweler Type Forceps			
960	HMI-SI-1195	Jeweler Type Forceps 12 cm / 4 6/8" 0,6 mm	
961	HMI-SI-1196	Jeweler Type Forceps 12 cm / 4 6/8" 0,5 mm	
962	HMI-SI-1197	Jeweler Type Forceps 12 cm / 4 6/8" 0,4 mm	

963	HMI-SI-1198	Jeweler Type Forceps 11 cm / 4 3/8" 0,6mm		
964	HMI-SI-1199	Jeweler Type Forceps 11 cm / 4 3/8" 0,4mm		
965	HMI-SI-1200	Jeweler Type Forceps 11 cm / 4 3/8" 0,3mm		
Tissue Forceps				
966	HMI-SI-1201	Tissue Forceps Russ. Modell 15 cm / 5 7/8"	 	
967	HMI-SI-1202	Tissue Forceps Russ. Modell 20 cm / 7 7/8"		
968	HMI-SI-1203	Tissue Forceps Russ. Modell 25,5 cm / 10"		
969	HMI-SI-1205	Tissue Forceps Durante 14,5 cm / 5 6/8"		
970	HMI-SI-1206	Tissue Forceps Durante 16 cm / 6 2/8"	 	

971	HMI-SI-1207	Tissue Forceps Durante 20,5 cm / 8 1/8"	
972	HMI-SI-1208	Tissue Forceps Durante 25 cm / 9 7/8"	
973	HMI-SI-1209	Tissue Forceps Stille-Barraya 18 cm / 7 1/8"	
974	HMI-SI-1210	Tissue Forceps Stille-Barraya 26 cm / 10 2/8"	
975	HMI-SI-1211	Tissue Forceps, Dissecting Forceps Bonney 17,5 cm / 6 7/8"	
976	HMI-SI-1212	Tissue Forceps, Dissecting Forceps Mayo 23 cm / 9"	
977	HMI-SI-1213	Tissue Forceps, Dissecting Forceps Singley-Tuttle 18 cm / 7 1/8"	
978	HMI-SI-1214	Tissue Forceps, Dissecting Forceps Singley-Tuttle 23 cm / 9"	

979	HMI-SI-1215	Tissue Forceps Nelson 23 cm / 9"	
980	HMI-SI-1216	Tissue Forceps Resano 23 cm / 9"	
981	HMI-SI-1217	Tissue Forceps Hepp-Scheidel Tubal forceps 18 cm / 7 1/8"	
982	HMI-SI-1218	Dissecting Forceps, Tissue Forceps delicate 10 cm / 3 6/8"	     
983	HMI-SI-1219	Dissecting Forceps, Tissue Forceps delicate 10 cm / 3 7/8"	
984	HMI-SI-1220	Dissecting Forceps, Tissue Forceps delicate 9,5 cm / 3 6/8"	
985	HMI-SI-1221	Dissecting Forceps, Tissue Forceps delicate 10 cm / 3 7/8"	
986	HMI-SI-1222	Dissecting Forceps, Tissue Forceps delicate 10 cm / 3 7/8"	

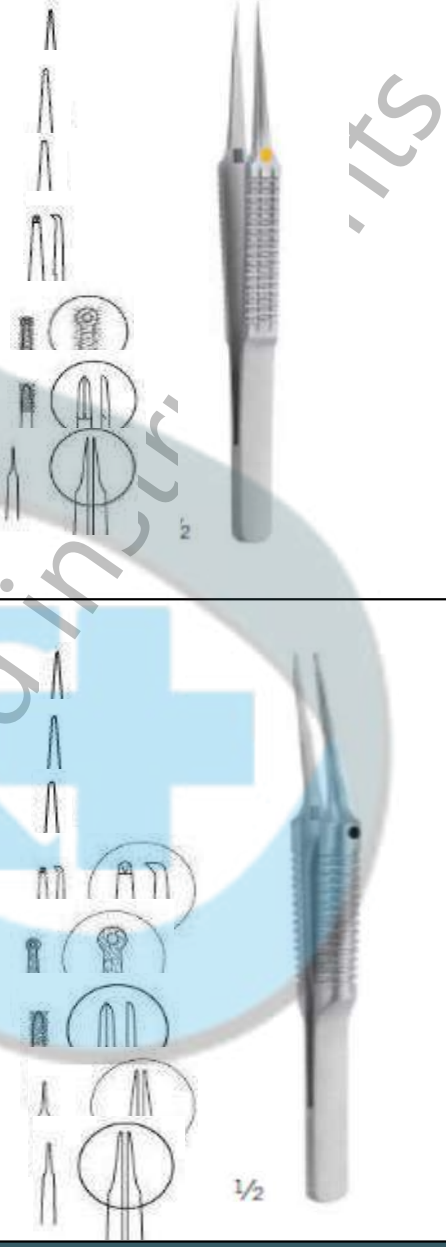
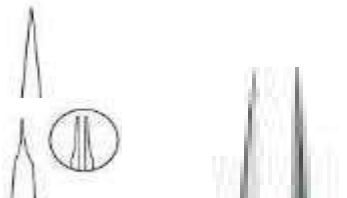
987	HMI-SI-1223	Dissecting Forceps, Tissue Forceps delicate 9,5 cm / 3 6/8"	
Short Micro Forceps			
988	HMI-SI-1224	Short Micro Forceps 11 cm / 4 3/8" St 0.50 mm	
989	HMI-SI-1225	Short Micro Forceps 11 cm / 4 3/8" St 0.20 mm	
990	HMI-SI-1226	Short Micro Forceps 11 cm / 4 3/8" St 0.30 mm	
991	HMI-SI-1227	Short Micro Forceps 11 cm / 4 3/8" St 0.50 mm	
992	HMI-SI-1228	Short Micro Forceps 11 cm / 4 3/8" St 1.2 mm	
993	HMI-SI-1229	Short Micro Forceps 11 cm / 4 3/8" St	
994	HMI-SI-1230	Short Micro Forceps 11 cm / 4 3/8" St Angled VD 0.10 mm	
995	HMI-SI-1231	Short Micro Forceps 11 cm / 4 3/8" St Angled VD 0.20 mm	
996	HMI-SI-1232	Short Micro Forceps 11 cm / 4 3/8" St Angled VD 0.30 mm	
997	HMI-SI-1233	Short Micro Forceps 11 cm / 4 3/8" St 0.50 mm	
998	HMI-SI-1234	Short Micro Forceps 11 cm / 4 3/8" St 0.20 mm	
999	HMI-SI-1235	Short Micro Forceps 11 cm / 4 3/8" St 0.30 mm	
1000	HMI-SI-1236	Short Micro Forceps 11 cm / 4 3/8" St 0.50 mm	
1001	HMI-SI-1237	Short Micro Forceps 11 cm / 4 3/8" St 1.2 mm	
1002	HMI-SI-1238	Short Micro Forceps 11 cm / 4 3/8" St	
1003	HMI-SI-1239	Short Micro Forceps 11 cm / 4 3/8" St Angled VD 0.10 mm	
1004	HMI-SI-1240	Short Micro Forceps 11 cm / 4 3/8" St Angled VD 0.20 mm	
1005	HMI-SI-1241	Short Micro Forceps 11 cm / 4 3/8" St Angled VD 0.30 mm	
Micro Forceps, Micro dilating forceps			
1006	HMI-SI-1242	Micro Forceps, Micro dilating forceps Jeweler mod. 11 cm / 4 3/8" St 0.30 mm	
1007	HMI-SI-1243	Micro Forceps, Micro dilating forceps Jeweler mod. 11 cm / 4 3/8" St VD 0.20 mm	

1008	HMI-SI-1244	Micro Forceps, Micro dilating forceps Jeweler mod. 11 cm / 4 3/8" St VD 0.30 mm
1009	HMI-SI-1245	Micro Forceps, Micro dilating forceps Jeweler mod. 11 cm / 4 3/8" St Pierse 0.30 mm
1010	HMI-SI-1246	Micro Forceps, Micro dilating forceps Jeweler mod. 11 cm / 4 3/8" St 45° 0.30 mm
1011	HMI-SI-1247	Micro Forceps, Micro dilating forceps Jeweler mod. 11 cm / 4 3/8" St 90° 0.30 mm
1012	HMI-SI-1248	Micro Forceps, Micro dilating forceps Jeweler mod. 13,5 cm / 5 3/8" St 0.30 mm
1013	HMI-SI-1249	Micro Forceps, Micro dilating forceps Jeweler mod. 13,5 cm / 5 3/8" St VD 0.20 mm
1014	HMI-SI-1250	Micro Forceps, Micro dilating forceps Jeweler mod. 13,5 cm / 5 3/8" St VD 0.30 mm
1015	HMI-SI-1251	Micro Forceps, Micro dilating forceps Jeweler mod. 13,5 cm / 5 3/8" St Pierse 0.30 mm
1016	HMI-SI-1252	Micro Forceps, Micro dilating forceps Jeweler mod. 13,5 cm / 5 3/8" St 45° 0.30 mm
1017	HMI-SI-1253	Micro Forceps, Micro dilating forceps Jeweler mod. 13,5 cm / 5 3/8" St 90° 0.30 mm
1018	HMI-SI-1254	Micro Forceps, Micro dilating forceps 15 cm / 5 7/8" St 0.30 mm
1019	HMI-SI-1255	Micro Forceps, Micro dilating forceps 15 cm / 5 7/8" St 0.30 mm
1020	HMI-SI-1256	Micro Forceps, Micro dilating forceps 15 cm / 5 7/8" St 0.30 mm 45°
1021	HMI-SI-1257	Micro Forceps, Micro dilating forceps 15 cm / 5 7/8" St 1.0 x 0.5 mm
1022	HMI-SI-1258	Micro Forceps, Micro dilating forceps 15 cm / 5 7/8" St VD 0.30 mm
1023	HMI-SI-1259	Micro Forceps, Micro dilating forceps 15 cm / 5 7/8" St Pierse 0.30 mm



1024	HMI-SI-1260	Micro Forceps, Micro dilating forceps 18 cm / 7 1/8" St 0.30 mm
1025	HMI-SI-1261	Micro Forceps, Micro dilating forceps 18 cm / 7 1/8" St 0.30 mm
1026	HMI-SI-1262	Micro Forceps, Micro dilating forceps 18 cm / 7 1/8" St 0.30 mm 45°
1027	HMI-SI-1263	Micro Forceps, Micro dilating forceps 18 cm / 7 1/8" St 1.0 x 0.5 mm
1028	HMI-SI-1264	Micro Forceps, Micro dilating forceps 18 cm / 7 1/8" St VD 0.30 mm
1029	HMI-SI-1265	Micro Forceps, Micro dilating forceps 18 cm / 7 1/8" St Pierse 0.30 mm
1030	HMI-SI-1266	Micro Forceps, Micro dilating forceps 15 cm / 5 7/8" St 0,40 mm
1031	HMI-SI-1267	Micro Forceps, Micro dilating forceps 15 cm / 5 7/8" St 0,40 mm
1032	HMI-SI-1268	Micro Forceps, Micro dilating forceps 15 cm / 5 7/8" St 0,70 mm
1033	HMI-SI-1269	Micro Forceps, Micro dilating forceps 15 cm / 5 7/8" St 0,70 mm
1034	HMI-SI-1270	Micro Forceps, Micro dilating forceps 15 cm / 5 7/8" Ti 0,40 mm
1035	HMI-SI-1271	Micro Forceps, Micro dilating forceps 15 cm / 5 7/8" Ti 0,40 mm
1036	HMI-SI-1272	Micro Forceps, Micro dilating forceps 15 cm / 5 7/8" Ti 0,80 mm
1037	HMI-SI-1273	Micro Forceps, Micro dilating forceps 15 cm / 5 7/8" Ti 0,80 mm
1038	HMI-SI-1274	Micro Forceps, Micro dilating forceps 18 cm / 7 1/8" St 0,40 mm
1039	HMI-SI-1275	Micro Forceps, Micro dilating forceps 18 cm / 7 1/8" St 0,40 mm

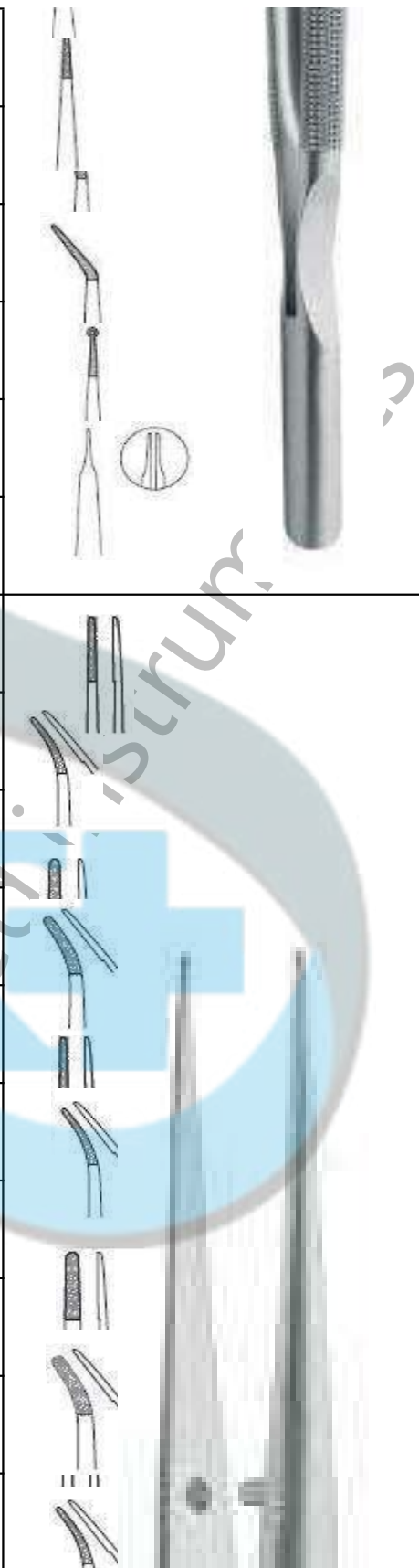

1040	HMI-SI-1276	Micro Forceps, Micro dilating forceps 18 cm / 7 1/8" St 0,70 mm
1041	HMI-SI-1277	Micro Forceps, Micro dilating forceps 18 cm / 7 1/8" St 0,70 mm
1042	HMI-SI-1278	Micro Forceps, Micro dilating forceps 18 cm / 7 1/8" Ti 0,40 mm
1043	HMI-SI-1279	Micro Forceps, Micro dilating forceps 18 cm / 7 1/8" Ti 0,40 mm
1044	HMI-SI-1280	Micro Forceps, Micro dilating forceps 18 cm / 7 1/8" Ti 0,70 mm
1045	HMI-SI-1281	Micro Forceps, Micro dilating forceps 18 cm / 7 1/8" Ti 0,70 mm
1046	HMI-SI-1282	Micro Forceps, Micro dilating forceps 21 cm / 8 2/8" St 0,70 mm
1047	HMI-SI-1283	Micro Forceps, Micro dilating forceps 21 cm / 8 2/8" St 0,70 mm
1048	HMI-SI-1284	Micro Forceps, Micro dilating forceps 21 cm / 8 2/8" Ti 0,80 mm
1049	HMI-SI-1285	Micro Forceps, Micro dilating forceps 21 cm / 8 2/8" Ti 0,80 mm
1050	HMI-SI-1286	Micro Forceps, Micro dilating forceps 23 cm / 9" St 0,70 mm
1051	HMI-SI-1287	Micro Forceps, Micro dilating forceps 23 cm / 9" St 0,70 mm
1052	HMI-SI-1288	Micro Forceps, Micro dilating forceps 23 cm / 9" Ti 0,80 mm
1053	HMI-SI-1289	Micro Forceps, Micro dilating forceps 23 cm / 9" Ti 0,80 mm
1054	HMI-SI-1290	Micro Forceps, Micro dilating forceps 25 cm / 9 7/8" St 0,70 mm
1055	HMI-SI-1291	Micro Forceps, Micro dilating forceps 25 cm / 9 7/8" St 0,70 mm
1056	HMI-SI-1292	Micro Forceps, Micro dilating forceps 25 cm / 9 7/8" Ti 0,80 mm
1057	HMI-SI-1293	Micro Forceps, Micro dilating forceps 25 cm / 9 7/8" Ti 0,80 mm

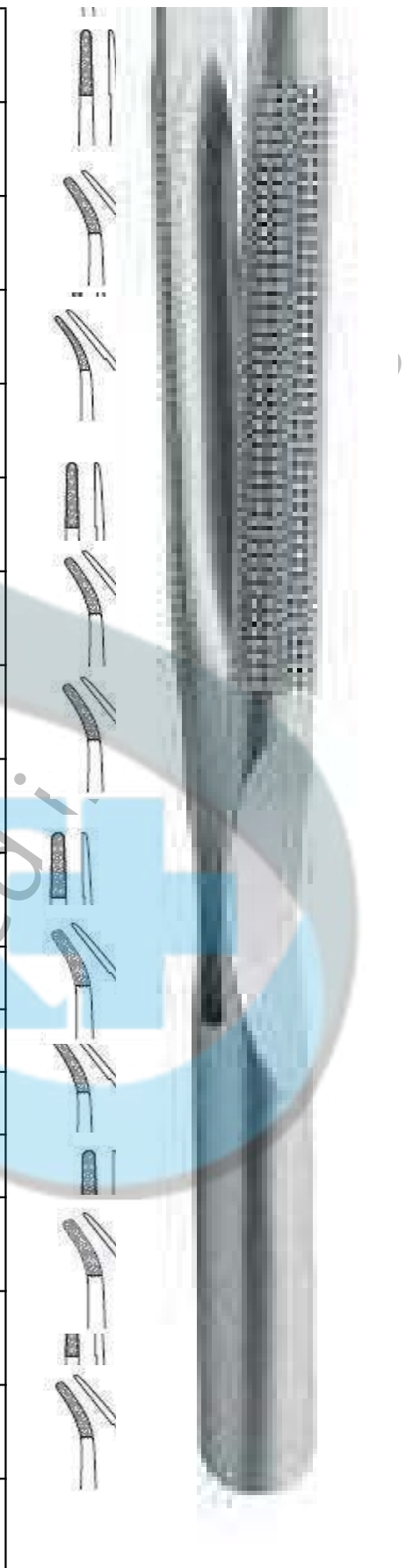

1058	HMI-SI-1294	Micro Forceps, Micro dilating forceps 15 cm / 5 7/8" 0.30 mm	
1059	HMI-SI-1295	Micro Forceps, Micro dilating forceps 15 cm / 5 7/8" 0.30 mm	
1060	HMI-SI-1296	Micro Forceps, Micro dilating forceps 15 cm / 5 7/8" 0.30 mm 45°	
1061	HMI-SI-1297	Micro Forceps, Micro dilating forceps 15 cm / 5 7/8" 1.0 x 0.5 mm	
1062	HMI-SI-1298	Micro Forceps, Micro dilating forceps 15 cm / 5 7/8" VD 0.30 mm	
1063	HMI-SI-1299	Micro Forceps, Micro dilating forceps 15 cm / 5 7/8" Pierse 0.40 mm	
1064	HMI-SI-1300	Micro Forceps, Micro dilating forceps 18 cm / 7 1/8" 0.30 mm	
1065	HMI-SI-1301	Micro Forceps, Micro dilating forceps 18 cm / 7 1/8" 0.30 mm	
1066	HMI-SI-1302	Micro Forceps, Micro dilating forceps 18 cm / 7 1/8" 0.30 mm 45°	
1067	HMI-SI-1303	Micro Forceps, Micro dilating forceps 18 cm / 7 1/8" 1.0 x 0.5 mm	
1068	HMI-SI-1304	Micro Forceps, Micro dilating forceps 18 cm / 7 1/8" VD 0.30 mm	
1069	HMI-SI-1305	Micro Forceps, Micro dilating forceps 18 cm / 7 1/8" Pierse 0.40 mm	
1070	HMI-SI-1306	Micro Forceps 18 cm / 7 1/8" 0.40 mm	
1071	HMI-SI-1307	Micro Forceps 18 cm / 7 1/8" 0.40 mm	
1072	HMI-SI-1308	Micro Forceps 18 cm / 7 1/8" 0.70 mm	
1073	HMI-SI-1309	Micro Forceps 18 cm / 7 1/8" 0.70 mm	
1074	HMI-SI-1310	Micro Forceps 21 cm / 8 2/8" 0.70 mm	
1075	HMI-SI-1311	Micro Forceps 21 cm / 8 2/8" 0.70 mm	
1076	HMI-SI-1312	Micro Forceps 23 cm / 9" 0.70 mm	

1077	HMI-SI-1313	Micro Forceps 23 cm / 9" 0.70 mm
1078	HMI-SI-1314	Micro Forceps 25 cm / 9 7/8" 0.70 mm
1079	HMI-SI-1314(a)	Micro Forceps 25 cm / 9 7/8" 0.70 mm
1080	HMI-SI-1315	Micro Forceps 18 cm / 7 1/8" 1.0 x 0.5 mm
1081	HMI-SI-1316	Micro Forceps 18 cm / 7 1/8" 1.0 x 0.5 mm
1082	HMI-SI-1317	Micro Forceps 18 cm / 7 1/8" 1.0 x 0.5 mm
1083	HMI-SI-1318	Micro Forceps 18 cm / 7 1/8" 2.0 x 1.0 mm
1084	HMI-SI-1319	Micro Forceps 18 cm / 7 1/8" 2.0 x 1.0 mm
1085	HMI-SI-1320	Micro Forceps 18 cm / 7 1/8" Atrauma 1.2 mm
1086	HMI-SI-1321	Micro Forceps 21 cm / 8 2/8" 1.0 x 0.5 mm
1087	HMI-SI-1322	Micro Forceps 21 cm / 8 2/8" 1.0 x 0.5 mm
1088	HMI-SI-1323	Micro Forceps 21 cm / 8 2/8" 1.0 x 0.5 mm
1089	HMI-SI-1324	Micro Forceps 21 cm / 8 2/8" 2.0 x 1.0 mm
1090	HMI-SI-1325	Micro Forceps 21 cm / 8 2/8" 2.0 x 1.0 mm
1091	HMI-SI-1326	Micro Forceps 21 cm / 8 2/8" Atrauma 1.2 mm
1092	HMI-SI-1327	Micro Forceps 23 cm / 9" 1.0 x 0.5 mm
1093	HMI-SI-1328	Micro Forceps 23 cm / 9" 1.0 x 0.5 mm
1094	HMI-SI-1329	Micro Forceps 23 cm / 9" 1.0 x 0.5 mm
1095	HMI-SI-1330	Micro Forceps 23 cm / 9" 2.0 x 1.0 mm
1096	HMI-SI-1331	Micro Forceps 23 cm / 9" 2.0 x 1.0 mm
1097	HMI-SI-1332	Micro Forceps 23 cm / 9" Atrauma 1.2 mm
1098	HMI-SI-1333	Micro Forceps 25 cm / 9 7/8" 1.0 x 0.5 mm
1099	HMI-SI-1334	Micro Forceps 25 cm / 9 7/8" 1.0 x 0.5 mm
1100	HMI-SI-1335	Micro Forceps 25 cm / 9 7/8" 1.0 x 0.5 mm

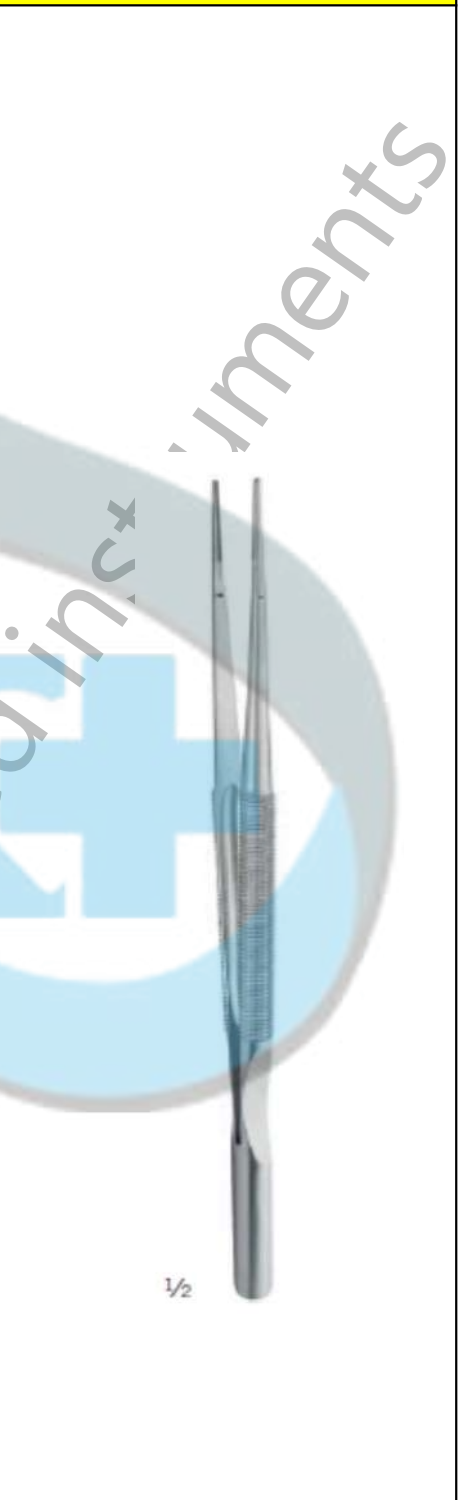

1101	HMI-SI-1336	Micro Forceps 25 cm / 9 7/8" 2.0 x 1.0 mm
1102	HMI-SI-1337	Micro Forceps 25 cm / 9 7/8" 2.0 x 1.0 mm
1103	HMI-SI-1338	Micro Forceps 25 cm / 9 7/8" Atrauma 1.2 mm
1104	HMI-SI-1339	Micro Forceps 15 cm / 5 7/8" St 0.40 mm
1105	HMI-SI-1340	Micro Forceps 15 cm / 5 7/8" St 0.40 mm
1106	HMI-SI-1341	Micro Forceps 15 cm / 5 7/8" St 0.70 mm
1107	HMI-SI-1342	Micro Forceps 15 cm / 5 7/8" St 0.70 mm
1108	HMI-SI-1343	Micro Forceps 15 cm / 5 7/8" Ti 0.40 mm
1109	HMI-SI-1344	Micro Forceps 15 cm / 5 7/8" Ti 0.40 mm
1110	HMI-SI-1345	Micro Forceps 15 cm / 5 7/8" Ti 0.80 mm
1111	HMI-SI-1346	Micro Forceps 15 cm / 5 7/8" Ti 0.80 mm
1112	HMI-SI-1347	Micro Forceps 18 cm / 7 1/8" St 0.40 mm
1113	HMI-SI-1348	Micro Forceps 18 cm / 7 1/8" St 0.40 mm
1114	HMI-SI-1349	Micro Forceps 18 cm / 7 1/8" St 0.70 mm
1115	HMI-SI-1350	Micro Forceps 18 cm / 7 1/8" St 0.70 mm
1116	HMI-SI-1351	Micro Forceps 18 cm / 7 1/8" Ti 0.40 mm
1117	HMI-SI-1352	Micro Forceps 18 cm / 7 1/8" Ti 0.40 mm
1118	HMI-SI-1353	Micro Forceps 18 cm / 7 1/8" Ti 0.80 mm
1119	HMI-SI-1354	Micro Forceps 18 cm / 7 1/8" Ti 0.80 mm
1120	HMI-SI-1355	Micro Forceps 21 cm / 8 2/8" St 0.70 mm
1121	HMI-SI-1356	Micro Forceps 21 cm / 8 2/8" St 0.70 mm
1122	HMI-SI-1357	Micro Forceps 21 cm / 8 2/8" Ti 0.80 mm
1123	HMI-SI-1358	Micro Forceps 21 cm / 8 2/8" Ti 0.80 mm
1124	HMI-SI-1359	Micro Forceps 23 cm / 9" St 0.70 mm
1125	HMI-SI-1360	Micro Forceps 23 cm / 9" St 0.70 mm



1/2

1126	HMI-SI-1361	Micro Forceps 15 cm / 5 7/8" St 1.0 x 0.5 mm
1127	HMI-SI-1362	Micro Forceps 15 cm / 5 7/8" St 1.0 x 0.5 mm
1128	HMI-SI-1363	Micro Forceps 15 cm / 5 7/8" St 1.0 x 0.5 mm
1129	HMI-SI-1364	Micro Forceps 15 cm / 5 7/8" St 2.0 x 1.0 mm
1130	HMI-SI-1365	Micro Forceps 15 cm / 5 7/8" St 2.0 x 1.0 mm
1131	HMI-SI-1366	Micro Forceps 15 cm / 5 7/8" St Atrauma 1.2 mm
1132	HMI-SI-1367	Micro Forceps 15 cm / 5 7/8" Ti 1.0 x 0.5 mm
1133	HMI-SI-1368	Micro Forceps 15 cm / 5 7/8" Ti 1.0 x 0.5 mm
1134	HMI-SI-1369	Micro Forceps 15 cm / 5 7/8" Ti 1.0 x 0.5 mm
1135	HMI-SI-1370	Micro Forceps 15 cm / 5 7/8" Ti 2.0 x 1.0 mm
1136	HMI-SI-1371	Micro Forceps 15 cm / 5 7/8" Ti 2.0 x 1.0 mm
1137	HMI-SI-1372	Micro Forceps 15 cm / 5 7/8" Ti Atrauma 1.2 mm
1138	HMI-SI-1373	Micro Forceps 18 cm / 7 1/8" St 1.0 x 0.5 mm
1139	HMI-SI-1374	Micro Forceps 18 cm / 7 1/8" St 1.0 x 0.5 mm
1140	HMI-SI-1375	Micro Forceps 18 cm / 7 1/8" St 1.0 x 0.5 mm
1141	HMI-SI-1376	Micro Forceps 18 cm / 7 1/8" St 2.0 x 1.0 mm
1142	HMI-SI-1377	Micro Forceps 18 cm / 7 1/8" St 2.0 x 1.0 mm
1143	HMI-SI-1378	Micro Forceps 18 cm / 7 1/8" St Atrauma 1.2 mm
1144	HMI-SI-1379	Micro Forceps 18 cm / 7 1/8" Ti 1.0 x 0.5 mm
1145	HMI-SI-1380	Micro Forceps 18 cm / 7 1/8" Ti 1.0 x 0.5 mm
1146	HMI-SI-1381	Micro Forceps 18 cm / 7 1/8" Ti 1.0 x 0.5 mm
1147	HMI-SI-1382	Micro Forceps 18 cm / 7 1/8" Ti 2.0 x 1.0 mm
1148	HMI-SI-1383	Micro Forceps 18 cm / 7 1/8" Ti 2.0 x 1.0 mm
1149	HMI-SI-1384	Micro Forceps 18 cm / 7 1/8" Ti Atrauma 1.2 mm
1150	HMI-SI-1385	Micro Forceps 21 cm / 8 2/8" St 1.0 x 0.5 mm















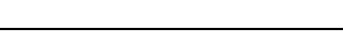









1126



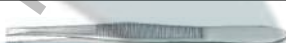



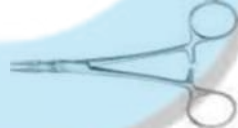

1126





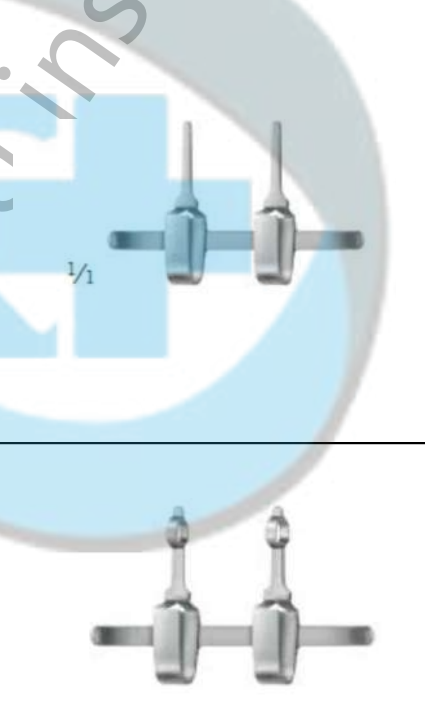



1/2

1151	HMI-SI-1386	Micro Forceps 21 cm / 8 2/8" St 1.0 x 0.5 mm
1152	HMI-SI-1387	Micro Forceps 21 cm / 8 2/8" St 1.0 x 0.5 mm
1153	HMI-SI-1388	Micro Forceps 21 cm / 8 2/8" St 2.0 x 1.0 mm
1154	HMI-SI-1389	Micro Forceps 21 cm / 8 2/8" St 2.0 x 1.0 mm
1155	HMI-SI-1390	Micro Forceps 21 cm / 8 2/8" St Atrauma 1.2 mm
1156	HMI-SI-1391	Micro Forceps 21 cm / 8 2/8" Ti 1.0 x 0.5 mm
1157	HMI-SI-1392	Micro Forceps 21 cm / 8 2/8" Ti 1.0 x 0.5 mm
1158	HMI-SI-1393	Micro Forceps 21 cm / 8 2/8" Ti 1.0 x 0.5 mm
1159	HMI-SI-1394	Micro Forceps 21 cm / 8 2/8" Ti 2.0 x 1.0 mm
1160	HMI-SI-1395	Micro Forceps 21 cm / 8 2/8" Ti 2.0 x 1.0 mm
1161	HMI-SI-1396	Micro Forceps 21 cm / 8 2/8" Ti Atrauma 1.2 mm
1162	HMI-SI-1397	Micro Forceps 23 cm / 9" St 1.0 x 0.5 mm
1163	HMI-SI-1398	Micro Forceps 23 cm / 9" St 1.0 x 0.5 mm
1164	HMI-SI-1399	Micro Forceps 23 cm / 9" St 1.0 x 0.5 mm
1165	HMI-SI-1400	Micro Forceps 23 cm / 9" St 2.0 x 1.0 mm
1166	HMI-SI-1401	Micro Forceps 23 cm / 9" St 2.0 x 1.0 mm
1167	HMI-SI-1402	Micro Forceps 23 cm / 9" St Atrauma 1.2 mm
1168	HMI-SI-1403	Micro Forceps 23 cm / 9" Ti 1.0 x 0.5 mm
1169	HMI-SI-1404	Micro Forceps 23 cm / 9" Ti 1.0 x 0.5 mm
1170	HMI-SI-1405	Micro Forceps 23 cm / 9" Ti 1.0 x 0.5 mm
1171	HMI-SI-1406	Micro Forceps 23 cm / 9" Ti 2.0 x 1.0 mm
1172	HMI-SI-1407	Micro Forceps 23 cm / 9" Ti 2.0 x 1.0 mm
1173	HMI-SI-1408	Micro Forceps 23 cm / 9" Ti Atrauma 1.2 mm
1174	HMI-SI-1409	Micro Forceps 25 cm / 9 7/8" St 1.0 x 0.5 mm
1175	HMI-SI-1410	Micro Forceps 25 cm / 9 7/8" St 1.0 x 0.5 mm

1176	HMI-SI-1411	Micro Forceps 25 cm / 9 7/8" St 1.0 x 0.5 mm	
1177	HMI-SI-1412	Micro Forceps 25 cm / 9 7/8" St 2.0 x 1.0 mm	
1178	HMI-SI-1413	Micro Forceps 25 cm / 9 7/8" St 2.0 x 1.0 mm	
1179	HMI-SI-1414	Micro Forceps 25 cm / 9 7/8" St Atrauma 1.2 mm	
1180	HMI-SI-1415	Micro Forceps 25 cm / 9 7/8" Ti 1.0 x 0.5 mm	
1181	HMI-SI-1416	Micro Forceps 25 cm / 9 7/8" Ti 1.0 x 0.5 mm	
1182	HMI-SI-1417	Micro Forceps 25 cm / 9 7/8" Ti 1.0 x 0.5 mm	
1183	HMI-SI-1418	Micro Forceps 25 cm / 9 7/8" Ti 2.0 x 1.0 mm	
1184	HMI-SI-1419	Micro Forceps 25 cm / 9 7/8" Ti 2.0 x 1.0 mm	
1185	HMI-SI-1420	Micro Forceps 25 cm / 9 7/8" Ti Atrauma 1.2 mm	
Splinter Forceps			
1186	HMI-SI-1421	Splinter Forceps smooth jaw 12,5 cm / 4 7/8"	
1187	HMI-SI-1422	Splinter Forceps smooth jaw 12,5 cm / 4 7/8"	
1188	HMI-SI-1424	Splinter Forceps serrated jaw 9 cm / 3 4/8"	
1189	HMI-SI-1425	Splinter Forceps serrated jaw 10,5 cm / 4 1/8"	
1190	HMI-SI-1426	Splinter Forceps serrated jaw 12,5 cm / 4 7/8"	
1191	HMI-SI-1427	Splinter Forceps serrated jaw 9 cm / 3 4/8"	
1192	HMI-SI-1428	Splinter Forceps serrated jaw 12,5 cm / 4 7/8"	
1193	HMI-SI-1429	Splinter Forceps Micro Tying Forceps, smooth jaw 15,5 cm / 6 1/8"	
1194	HMI-SI-1430	Splinter Forceps Lazar 15,5 cm / 6 1/8" 0,5 mm	
1195	HMI-SI-1431	Splinter Forceps Lazar 15,5 cm / 6 1/8" 0,8 mm	
1196	HMI-SI-1432	Splinter Forceps 12 cm / 5 6/8" 0,3 mm	
1197	HMI-SI-1433	Splinter Forceps Austin 14 cm / 5 4/8"	
1198	HMI-SI-1434	Splinter Forceps Feilchenfeld 7,5 cm / 3"	
1199	HMI-SI-1435	Splinter Forceps Feilchenfeld 9 cm / 3 4/8"	

1200	HMI-SI-1436	Splinter Forceps Feilchenfeld 11,5 cm / 4 4/8"	
1201	HMI-SI-1437	Splinter Forceps, Microscopic Forceps Hunter 10,5 cm / 4 1/8"	
1202	HMI-SI-1438	Splinter Forceps, Microscopic Forceps Hunter 10,5 cm / 4 1/8"	
1203	HMI-SI-1439	Splinter Forceps, Microscopic Forceps 10 cm / 3 7/8"	
1204	HMI-SI-1440	Splinter Forceps, Microscopic Forceps 10 cm / 3 7/8"	
1205	HMI-SI-1441	Microscopic Forceps, super light, blunt Pinza 10 cm / 3 7/8"	
1206	HMI-SI-1442	Microscopic Forceps, super light, sharp 10 cm / 3 7/8"	
1207	HMI-SI-1443	Microscopic Forceps Shaaf 9,5 cm / 3 6/8"	
Cilia Forceps			
1208	HMI-SI-1444	Cilia Forceps Littauer smooth jaw 8,5 cm / 3 3/8"	
1209	HMI-SI-1445	Cilia Forceps 9 cm / 3 4/8"	
1210	HMI-SI-1446	Cilia Forceps Douglas 9 cm / 3 4/8"	
1211	HMI-SI-1447	Cilia Forceps Douglas 9 cm / 3 4/8"	
1212	HMI-SI-1448	Cilia Forceps Beer Smooth Jaws 9 cm / 3 4/8"	
1213	HMI-SI-1449	Cilia Forceps Barraquer Smooth Jaws 11 cm / 4 3/8"	
Splinter Forceps			
1214	HMI-SI-1450	Splinter Forceps Stieglitz 14 cm / 5 4/8"	
1215	HMI-SI-1451	Splinter Forceps Stieglitz 13,5 cm / 5 3/8"	
1216	HMI-SI-1452	Splinter Forceps Peet 12,5 cm / 4 7/8"	
1217	HMI-SI-1453	Splinter Forceps Ralk 15 cm / 5 7/8"	

1218	HMI-SI-1454	Splinter Forceps Ralk 14 cm / 5 4/8"	
Clip Applying Forceps, Vessel Clips			
1219	HMI-SI-1455	Clip Applying Forceps, Vessel Clips Biemer Vascular spreader 16 cm / 6 2/8"	
1220	HMI-SI-1456	Clip Applying Forceps, Vessel Clips w/o ratchet 14,5 cm / 5 6/8"	
1221	HMI-SI-1457	Clip Applying Forceps, Vessel Clips with ratchet 14,5 cm / 5 6/8"	
1222	HMI-SI-1458	Clip Applying Forceps, Vessel Clips Biemer	
1223	HMI-SI-1459	Clip Applying Forceps, Vessel Clips Biemer	
1224	HMI-SI-1460	Clip Applying Forceps, Vessel Clips Biemer	
1225	HMI-SI-1461	Vessel Clips, Approximators Biemer-Müller straight, wide	
1226	HMI-SI-1462	Vessel Clips, Approximators Biemer-Müller angled, wide	
1227	HMI-SI-1463	Vessel Clips, Approximators Biemer-Müller straight, narrow	
1228	HMI-SI-1464	Vessel Clips, Approximators Biemer-Müller straight, narrow	
1229	HMI-SI-1465	Vessel Clips, Approximators Biemer-Müller angled, narrow	
1230	HMI-SI-1466	Vessel Clips, Approximators Müller 1,5 mm	
1231	HMI-SI-1467	Vessel Clips, Approximators Müller 2,5 mm	
1232	HMI-SI-1468	Vessel Clips, Approximators Müller 3 mm	
1233	HMI-SI-1469	Vessel Clips, Approximators Müller 3,5 mm	
Approximators, Nerve Approximators			
1234	HMI-SI-1470	Approximators, Nerve Approximators complete with key	
1235	HMI-SI-1471	Approximators, Nerve Approximators Key for Approximator Llave	

1236	HMI-SI-1472	Approximators, Nerve Approximators only	
1237	HMI-SI-1473	Approximators, Nerve Approximators complete with key	
1238	HMI-SI-1474	Approximator with needles, only	
1239	HMI-SI-1475	Needles, only Aguja de	
1240	HMI-SI-1476	Mini Vessel Clips, Clip Applying Forceps with ratchet	
1241	HMI-SI-1477	Mini Vessel Clips, Clip Applying Forceps with ratchet	
1242	HMI-SI-1478	Mini Vessel Clips, Clip Applying Forceps 0,75	
1243	HMI-SI-1479	Mini Vessel Clips, Clip Applying Forceps 1,0	
1244	HMI-SI-1480	Mini Vessel Clips, Clip Applying Forceps 2,0	
1245	HMI-SI-1481	Mini Vessel Clips, Clip Applying Forceps 2,1	
Bulldog Clamps			
1246	HMI-SI-1482	Bulldog Clamps	
1247	HMI-SI-1483	Bulldog Clamps	
1248	HMI-SI-1484	Bulldog Clamps	
1249	HMI-SI-1485	Bulldog Clamps	
1250	HMI-SI-1486	Bulldog Clamps	
1251	HMI-SI-1487	Bulldog Clamps	
1252	HMI-SI-1488 (a)	Bulldog Clamps Die°enbach	

1253	HMI-SI-1488(b)	Bulldog Clamps Die°enbach
1254	HMI-SI-1488©	Bulldog Clamps Die°enbach
1255	HMI-SI-1488(d)	Bulldog Clamps Die°enbach
1256	HMI-SI-1488€	Bulldog Clamps Die°enbach
1257	HMI-SI-1488(f)	Bulldog Clamps Die°enbach
1258	HMI-SI-1489(a)	Bulldog Clamps Johns-Hopkins
1259	HMI-SI-1489(b)	Bulldog Clamps Johns-Hopkins
1260	HMI-SI-1489(c)	Bulldog Clamps Johns-Hopkins
1261	HMI-SI-1489(d)	Bulldog Clamps Johns-Hopkins
1262	HMI-SI-1489(e)	Bulldog Clamps Johns-Hopkins
1263	HMI-SI-1489(f)	Bulldog Clamps Johns-Hopkins
1264	HMI-SI-1489(g)	Bulldog Clamps Johns-Hopkins
1265	HMI-SI-1490(a)	Bulldog Clamps Johns-Hopkins
1266	HMI-SI-1490(b)	Bulldog Clamps Johns-Hopkins
1267	HMI-SI-1490©	Bulldog Clamps Johns-Hopkins
1268	HMI-SI-1490(d)	Bulldog Clamps Johns-Hopkins
1269	HMI-SI-1490€	Bulldog Clamps Johns-Hopkins
1270	HMI-SI-1490(f)	Bulldog Clamps Johns-Hopkins

1/2



1/2







1271	HMI-SI-1490(g)	Bulldog Clamps Johns-Hopkins
1272	HMI-SI-1501	Bulldog Clamps Diethrich
1273	HMI-SI-1502	Bulldog Clamps Diethrich
1274	HMI-SI-1503	Bulldog Clamps Diethrich
1275	HMI-SI-1504	Bulldog Clamps Diethrich
1276	HMI-SI-1505	Bulldog Clamps Diethrich
1277	HMI-SI-1506	Bulldog Clamps Diethrich
1278	HMI-SI-1507	Bulldog Clamps DeBakey-Diethrich Atrauma St
1279	HMI-SI-1508	Bulldog Clamps DeBakey-Diethrich Atrauma Ti
1280	HMI-SI-1509	Bulldog Clamps DeBakey-Diethrich Atrauma St
1281	HMI-SI-1510	Bulldog Clamps DeBakey-Diethrich Atrauma Ti
1282	HMI-SI-1511	Bulldog Clamps DeBakey-Diethrich Atrauma St
1283	HMI-SI-1512	Bulldog Clamps DeBakey-Diethrich Atrauma Ti
1284	HMI-SI-1513	Bulldog Clamps DeBakey-Diethrich Atrauma St
1285	HMI-SI-1514	Bulldog Clamps DeBakey-Diethrich Atrauma Ti
1286	HMI-SI-1515	Bulldog Clamps DeBakey-Diethrich Atrauma St
1287	HMI-SI-1516	Bulldog Clamps DeBakey-Diethrich Atrauma Ti
1288	HMI-SI-1517	Bulldog Clamps DeBakey-Diethrich Atrauma St
1289	HMI-SI-1518	Bulldog Clamps DeBakey-Diethrich Atrauma Ti
1290	HMI-SI-1519	Bulldog Clamps DeBakey-Diethrich Atrauma St
1291	HMI-SI-1520	Bulldog Clamps DeBakey-Diethrich Atrauma Ti
1292	HMI-SI-1521	Bulldog Clamps DeBakey-Diethrich Atrauma St
1293	HMI-SI-1522	Bulldog Clamps DeBakey-Diethrich Atrauma Ti
1294	HMI-SI-1523	Bulldog Clamps DeBakey-Diethrich Atrauma St



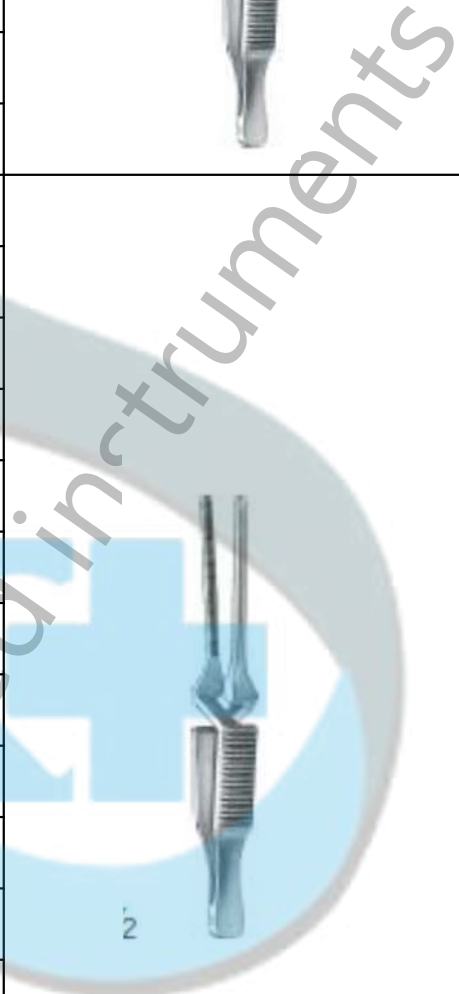

1/2







2







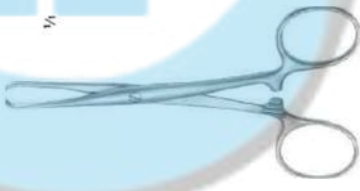

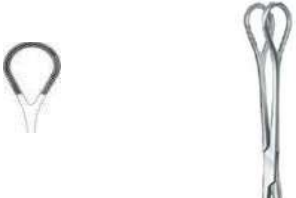

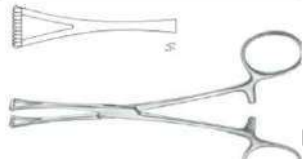



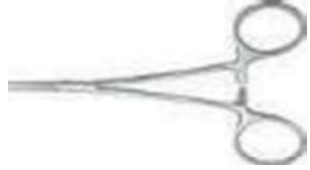

1295	HMI-SI-1524	Bulldog Clamps DeBakey-Diethrich Atrauma Ti	
1296	HMI-SI-1525	Bulldog Clamps Muller	
1297	HMI-SI-1526	Bulldog Clamps Muller	
1298	HMI-SI-1527	Bulldog Clamps Muller	
1299	HMI-SI-1528	Bulldog Clamps Muller	
1300	HMI-SI-1529	Bulldog Clamps Muller	
1301	HMI-SI-1530	Bulldog Clamps Muller	
1302	HMI-SI-1531	Bulldog Clamps Muller	
1303	HMI-SI-1532	Bulldog Clamps Muller	
1304	HMI-SI-1533	Bulldog Clamps Muller	
1305	HMI-SI-1534	Bulldog Clamps Muller	
1306	HMI-SI-1535	Bulldog Clamps Atrauma	
1307	HMI-SI-1536	Bulldog Clamps Atrauma	
1308	HMI-SI-1537	Bulldog Clamps Atrauma	
1309	HMI-SI-1538	Bulldog Clamps Atrauma	
1310	HMI-SI-1539	Bulldog Clamps Atrauma	
1311	HMI-SI-1540	Bulldog Clamps Atrauma	
1312	HMI-SI-1541	Bulldog Clamps Atrauma	
1313	HMI-SI-1542	Bulldog Clamps Atrauma	
1314	HMI-SI-1543	Bulldog Clamps Atrauma Mini-Glover Vena	
1315	HMI-SI-1544	Bulldog Clamps Atrauma Mini-Glover Vena	
1316	HMI-SI-1545	Bulldog Clamps Atrauma Mini-Glover Vena	
1317	HMI-SI-1546	Bulldog Clamps Atrauma Mini-Glover Vena	
1318	HMI-SI-1547	Bulldog Clamps Atrauma Mini-Glover Arteria	
1319	HMI-SI-1548	Bulldog Clamps Atrauma Mini-Glover Arteria	



1320	HMI-SI-1549	Bulldog Clamps Atrauma Mini-Glover Arteria		
1321	HMI-SI-1550	Bulldog Clamps Atrauma Mini-Glover Arteria	$\frac{1}{2}$	
1322	HMI-SI-1551	Bulldog Clamps Atrauma Mini-Glover Vena		
1323	HMI-SI-1552	Bulldog Clamps Atrauma Mini-Glover Vena		
1324	HMI-SI-1553	Bulldog Clamps Atrauma Mini-Glover Vena		
1325	HMI-SI-1554	Bulldog Clamps Atrauma Mini-Glover Vena		
1326	HMI-SI-1555	Bulldog Clamps Atrauma Mini-Glover Arteria		
1327	HMI-SI-1556	Bulldog Clamps Atrauma Mini-Glover Arteria		
1328	HMI-SI-1557	Bulldog Clamps Atrauma Mini-Glover Arteria		
1329	HMI-SI-1558	Bulldog Clamps Atrauma Mini-Glover Arteria		
1330	HMI-SI-1559	Bulldog Clamps Atrauma Mini-Glover Arteria		
1331	HMI-SI-1560	Bulldog Clamps Atrauma Mini-Glover Arteria		
1332	HMI-SI-1561	Bulldog Clamps Atrauma Mini-Glover Arteria		
1333	HMI-SI-1562	Bulldog Clamps Atrauma Mini-Glover Arteria		
1334	HMI-SI-1563	Bulldog Clamps Atrauma Mini-Glover Arteria		
1335	HMI-SI-1564	Bulldog Clamps Atrauma Mini-Glover Arteria		
1336	HMI-SI-1565	Bulldog Clamps Atrauma Mini-Glover Arteria		
1337	HMI-SI-1566	Bulldog Clamps Atrauma Mini-Glover Arteria		
1338	HMI-SI-1566(a)	Applying Forceps for Bulldog clamps, Mini-Glover		



Haemostatic Forceps













1339	HMI-SI-1567	Haemostatic Forceps Pean 14,5 cm / 5 6/8"	
1340	HMI-SI-1568	Haemostatic Forceps Pean 16 cm / 6 2/8"	
1341	HMI-SI-1569	Haemostatic Forceps Spencer-Wells 13 cm / 5 1/8"	
1342	HMI-SI-1570	Haemostatic Forceps Spencer-Wells 14,5 cm / 5 6/8"	
1343	HMI-SI-1571	Haemostatic Forceps Spencer-Wells 15,5 cm / 6 1/8"	
1344	HMI-SI-1572	Haemostatic Forceps Spencer-Wells 18,5 cm / 7 2/8"	
1345	HMI-SI-1573	Haemostatic Forceps Spencer-Wells 20 cm / 7 7/8"	
1346	HMI-SI-1574	Haemostatic Forceps Spencer-Wells 13 cm / 5 1/8"	
1347	HMI-SI-1575	Haemostatic Forceps Spencer-Wells 14,5 cm / 5 6/8"	
1348	HMI-SI-1576	Haemostatic Forceps Spencer-Wells 15,5 cm / 6 1/8"	
1349	HMI-SI-1577	Haemostatic Forceps Spencer-Wells 18,5 cm / 7 2/8"	
1350	HMI-SI-1578	Haemostatic Forceps Spencer-Wells 20 cm / 7 7/8"	
1351	HMI-SI-1579	Haemostatic Forceps, Organ Grasping Forceps Chaput 12,5 cm / 4 7/8"	
1352	HMI-SI-1580	Haemostatic Forceps, Organ Grasping Forceps Tu"er 12,5 cm / 4 7/8"	
1353	HMI-SI-1581	Haemostatic Forceps, Organ Grasping Forceps Atrauma 25 cm / 9 7/8"	





1354	HMI-SI-1582	Haemostatic Forceps, Organ Grasping Forceps Atrauma 26 cm / 10 2/8"	
Organ Grasping Forceps			
1355	HMI-SI-1583	Organ Grasping Forceps Collin 14 cm / 5 4/8"	
1356	HMI-SI-1584	Organ Grasping Forceps Collin Rumor Grasping Forcep 17 cm / 6 6/8"	
1357	HMI-SI-1585	Organ Grasping Forceps Pennington 15,5 cm / 6 1/8"	
1358	HMI-SI-1586	Organ Grasping Forceps Pennington 21 cm / 8 2/8"	
1359	HMI-SI-1587	Organ Grasping Forceps Pratt 15 cm / 5 7/8"	
1360	HMI-SI-1588	Haemostatic Forceps Martel-Rees Face-lift Forceps 13,5 cm / 5 3/8"	
1361	HMI-SI-1589	Haemostatic Forceps Ligature Forceps, smooth jaw 12,5 cm / 4 7/8"	









1362	HMI-SI-1590	Haemostatic Forceps Mixer-Baby 13 cm / 5 1/8"	
1363	HMI-SI-1591	Haemostatic Forceps Mixer-Baby 13,5 cm / 5 3/8"	
1364	HMI-SI-1592	Haemostatic Forceps Mikro-Adson 14 cm / 5 4/8"	
1365	HMI-SI-1593	Haemostatic Forceps Baby-Adson 18 cm / 7 1/8"	
1366	HMI-SI-1594	Haemostatic Forceps Hartmann 10 cm / 3 7/8"	
1367	HMI-SI-1595	Haemostatic Forceps Hartmann 10 cm / 3 7/8"	
1368	HMI-SI-1596	Haemostatic Forceps Ligature Forceps 12 cm / 4 6/8"	
1369	HMI-SI-1597	Haemostatic Forceps Halsted- Mosquito 12,5 cm / 4 7/8"	
1370	HMI-SI-1598	Haemostatic Forceps Halsted- Mosquito 14,5 cm / 5 6/8"	
1371	HMI-SI-1599	Haemostatic Forceps Halsted- Mosquito 12 cm / 4 6/8"	
1372	HMI-SI-1600	Haemostatic Forceps Halsted- Mosquito 14 cm / 5 4/8"	

1373	HMI-SI-1601	Haemostatic Forceps Halsted-Mosquito 12,5 cm / 4 7/8"	
1374	HMI-SI-1602	Haemostatic Forceps Halsted-Mosquito 14,5 cm / 5 6/8"	
1375	HMI-SI-1603	Haemostatic Forceps Halsted-Mosquito 12,5 cm / 4 7/8"	
1376	HMI-SI-1604	Haemostatic Forceps Halsted-Mosquito 14,5 cm / 5 6/8"	
1377	HMI-SI-1606	Haemostatic Forceps Halsted-Mosquito 12,5 cm / 4 7/8"	
1378	HMI-SI-1607	Haemostatic Forceps Halsted-Mosquito 12 cm / 4 6/8"	
1379	HMI-SI-1608	Haemostatic Forceps Halsted-Mosquito 12 cm / 4 6/8"	
1380	HMI-SI-1609	Haemostatic Forceps Halsted-Mosquito 12 cm / 4 6/8"	
1381	HMI-SI-1610	Haemostatic Forceps Halsted-Mosquito 18,5 cm / 7 2/8"	
1382	HMI-SI-1611	Haemostatic Forceps Halsted-Mosquito 21 cm / 8 2/8"	
1383	HMI-SI-1612	Haemostatic Forceps Halsted-Mosquito 18 cm / 7 1/8"	
1384	HMI-SI-1613	Haemostatic Forceps Halsted-Mosquito 20,5 cm / 8 1/8"	
1385	HMI-SI-1614	Haemostatic Forceps Halsted-Mosquito 18,5 cm / 7 2/8"	
1386	HMI-SI-1615	Haemostatic Forceps Halsted-Mosquito 21 cm / 8 2/8"	
1387	HMI-SI-1616	Haemostatic Forceps Halsted-Mosquito 20,5 cm / 8 1/8"	
1388	HMI-SI-1617	Haemostatic Forceps Halsted-Mosquito 18,5 cm / 7 2/8"	
1389	HMI-SI-1618	Haemostatic Forceps Mikro-Mosquito 10 cm / 3 7/8"	





1390	HMI-SI-1619	Haemostatic Forceps Mikro-Mosquito 12 cm / 4 6/8"	
1391	HMI-SI-1620	Haemostatic Forceps Mikro-Mosquito 10 cm / 3 7/8"	
1392	HMI-SI-1621	Haemostatic Forceps Mikro-Mosquito 12 cm / 4 6/8"	
1393	HMI-SI-1622	Haemostatic Forceps Mikro-Mosquito 10 cm / 3 7/8"	
1394	HMI-SI-1623	Haemostatic Forceps Mikro-Mosquito 12 cm / 4 6/8"	
1395	HMI-SI-1624	Haemostatic Forceps Mikro-Mosquito 10 cm / 3 7/8"	
1396	HMI-SI-1625	Haemostatic Forceps Mikro-Mosquito 12 cm / 4/8"	
1397	HMI-SI-1626	Haemostatic Forceps Providence-Hospital 14 cm / 5 4/8"	
1398	HMI-SI-1627	Haemostatic Forceps Providence-Hospital 13,5 cm / 5 3/8"	
1399	HMI-SI-1628	Haemostatic Forceps Leriche 15,5 cm / 6 1/8"	
1400	HMI-SI-1629	Haemostatic Forceps Leriche 15 cm / 5 7/8"	
1401	HMI-SI-1630	Haemostatic Forceps Leriche 15,5 cm / 6 1/8"	
1402	HMI-SI-1631	Haemostatic Forceps Leriche 15 cm / 5 7/8"	

1403	HMI-SI-1632	Haemostatic Forceps Kelly 14,5 cm / 5 6/8"		
1404	HMI-SI-1633	Haemostatic Forceps Kelly 14,5 cm / 5 6/8" Ti		
1405	HMI-SI-1634	Haemostatic Forceps Kelly 14 cm / 5 4/8"		
1406	HMI-SI-1635	Haemostatic Forceps Kelly 14 cm / 5 4/8" Ti		
1407	HMI-SI-1636	Haemostatic Forceps Dunhill 12,5 cm / 4 7/8"		
1408	HMI-SI-1637	Haemostatic Forceps Dunhill 18,5 cm / 7 2/8"		
1409	HMI-SI-1638	Dissecting and Ligature Forceps Kelly-Rankin 16 cm / 6 2/8"		
1410	HMI-SI-1639	Dissecting and Ligature Forceps Kelly-Rankin 16 cm / 6 2/8"		

1411	HMI-SI-1640	Dissecting and Ligature Forceps Overholt-Baby 13,5 cm / 5 3/8"	
1412	HMI-SI-1641	Dissecting and Ligature Forceps Crile 14,5 cm / 5 6/8"	
1413	HMI-SI-1642	Dissecting and Ligature Forceps Crile 14,5 cm / 5 6/8" Ti	
1414	HMI-SI-1643	Dissecting and Ligature Forceps Crile 14,5 cm / 5 6/8"	
1415	HMI-SI-1644	Dissecting and Ligature Forceps Crile 14,5 cm / 5 6/8" Ti	
1416	HMI-SI-1645	Dissecting and Ligature Forceps Crile 14,5 cm / 5 6/8"	
1417	HMI-SI-1646	Dissecting and Ligature Forceps Crile 14,5 cm / 5 6/8"	
1418	HMI-SI-1647	Dissecting and Ligature Forceps Crile-Rankin 16 cm / 6 2/8"	
1419	HMI-SI-1648	Dissecting and Ligature Forceps Crile-Rankin 16 cm / 6 2/8"	
1420	HMI-SI-1649	Dissecting and Ligature Forceps Lovelace cross serrated jaw 16 cm / 6 2/8"	
1421	HMI-SI-1650	Dissecting and Ligature Forceps Lovelace cross serrated jaw 16 cm / 6 2/8"	
1422	HMI-SI-1651	Dissecting and Ligature Forceps Dandy-Mosquito laterally curved 12 cm / 4 6/8"	







1423	HMI-SI-1652	Dissecting and Ligature Forceps Dandy laterally curved 14,5 cm / 5 6/8"	
1424	HMI-SI-1653	Dissecting and Ligature Forceps Dandy laterally curved 14 cm / 5 4/8"	
1425	HMI-SI-1654	Dissecting and Ligature Forceps Schnidt 18,5 cm / 7 2/8"	
1426	HMI-SI-1655	Dissecting and Ligature Forceps Schnidt 19 cm / 7 4/8"	
1427	HMI-SI-1656	Dissecting and Ligature Forceps Adson 19 cm / 7 4/8"	
1428	HMI-SI-1657	Dissecting and Ligature Forceps Adson 18,5 cm / 7 2/8"	
1429	HMI-SI-1658	Dissecting and Ligature Forceps Martin-Fuchsig 20,5 cm / 8 1/8"	
1430	HMI-SI-1659	Dissecting and Ligature Forceps Rochester-Carmalt 17 cm / 6 6/8"	



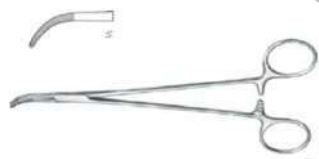



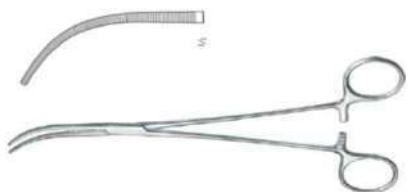

1431	HMI-SI-1660	Dissecting and Ligature Forceps Rochester-Carmalt 20,5 cm / 8 1/8"	
1432	HMI-SI-1661	Dissecting and Ligature Forceps Rochester-Carmalt 16,5 cm / 6 4/8"	
1433	HMI-SI-1662	Dissecting and Ligature Forceps Rochester-Carmalt 20 cm / 7 7/8"	
1434	HMI-SI-1663	Haemostatic Forceps Pean 13,5 cm / 5 3/8"	
1435	HMI-SI-1664	Haemostatic Forceps Pean 14,5 cm / 5 6/8"	
1436	HMI-SI-1665	Haemostatic Forceps Pean 17 cm / 6 6/8"	
1437	HMI-SI-1666	Haemostatic Forceps Pean 13 cm / 5 1/8"	
1438	HMI-SI-1667	Haemostatic Forceps Pean 14 cm / 5 4/8"	
1439	HMI-SI-1668	Haemostatic Forceps Pean 16,5 cm / 6 4/8"	
1440	HMI-SI-1669	Haemostatic Forceps Pean-Nippon 14,5 cm / 5 6/8"	
1441	HMI-SI-1670	Haemostatic Forceps Pean-Nippon 16,5 cm / 6 4/8"	
1442	HMI-SI-1671	Haemostatic Forceps Pean-Nippon 18,5 cm / 7 2/8"	
1443	HMI-SI-1672	Haemostatic Forceps Pean-Nippon 14 cm / 5 4/8"	
1444	HMI-SI-1673	Haemostatic Forceps Pean-Nippon 16 cm / 6 2/8"	
1445	HMI-SI-1674	Haemostatic Forceps Pean-Nippon 18 cm / 7 1/8"	
1446	HMI-SI-1675	Haemostatic Forceps Kocher-Nippon 14,5 cm / 5 6/8"	
1447	HMI-SI-1676	Haemostatic Forceps Kocher-Nippon 16,5 cm / 6 4/8"	
1448	HMI-SI-1677	Haemostatic Forceps Kocher-Nippon 18,5 cm / 7 2/8"	
1449	HMI-SI-1678	Haemostatic Forceps Kocher-Nippon 14 cm / 5 4/8"	

1450	HMI-SI-1679	Haemostatic Forceps Kocher-Nippon 16 cm / 6 2/8"	
1451	HMI-SI-1680	Haemostatic Forceps Kocher-Nippon 18 cm / 7 1/8"	
1452	HMI-SI-1681	Haemostatic Forceps Kocher 13 cm / 5 1/8"	
1453	HMI-SI-1682	Haemostatic Forceps Kocher 14 cm / 5 4/8"	
1454	HMI-SI-1683	Haemostatic Forceps Kocher 16 cm / 6 2/8"	
1455	HMI-SI-1684	Haemostatic Forceps Kocher 13 cm / 5 1/8"	
1456	HMI-SI-1685	Haemostatic Forceps Kocher 14 cm / 5 4/8"	
1457	HMI-SI-1686	Haemostatic Forceps Kocher 16 cm / 6 2/8"	
1458	HMI-SI-1687	Haemostatic Forceps Bengolea 21,5 cm / 8 4/8"	
1459	HMI-SI-1688	Haemostatic Forceps Bengolea 26 cm / 10 2/8"	
1460	HMI-SI-1689	Haemostatic Forceps Bengolea 21,5 cm / 8 4/8"	
1461	HMI-SI-1690	Haemostatic Forceps Bengolea 26 cm / 10 2/8"	
1462	HMI-SI-1691	Haemostatic Forceps Bengolea 21,5 cm / 8 4/8"	
1463	HMI-SI-1692	Haemostatic Forceps Bengolea 26 cm / 10 2/8"	
1464	HMI-SI-1693	Haemostatic Forceps Bengolea 21,5 cm / 8 4/8"	
1465	HMI-SI-1694	Haemostatic Forceps Bengolea 26 cm / 10 2/8"	
1466	HMI-SI-1695	Haemostatic Forceps Pean (Rochester) 14,5 cm / 5 6/8"	
1467	HMI-SI-1696	Haemostatic Forceps Pean (Rochester) 16,5 cm / 6 4/8"	
1468	HMI-SI-1697	Haemostatic Forceps Pean (Rochester) 18,5 cm / 7 2/8"	
1469	HMI-SI-1698	Haemostatic Forceps Pean (Rochester) 20,5 cm / 8 1/8"	
1470	HMI-SI-1699	Haemostatic Forceps Pean (Rochester) 22,5 cm / 8 7/8"	
1471	HMI-SI-1700	Haemostatic Forceps Pean (Rochester) 24 cm / 9 4/8"	
1472	HMI-SI-1701	Haemostatic Forceps Pean (Rochester) 26 cm / 10 2/8"	
1473	HMI-SI-1702	Haemostatic Forceps Pean (Rochester) 31 cm / 12 2/8"	
1474	HMI-SI-1703	Haemostatic Forceps Pean (Rochester) 14 cm / 5 4/8"	

1475	HMI-SI-1704	Haemostatic Forceps Pean (Rochester) 16,5 cm / 6 4/8"
1476	HMI-SI-1705	Haemostatic Forceps Pean (Rochester) 18,5 cm / 7 2/8"
1477	HMI-SI-1706	Haemostatic Forceps Pean (Rochester) 20,5 cm / 8 1/8"
1478	HMI-SI-1707	Haemostatic Forceps Pean (Rochester) 22 cm / 8 5/8"
1479	HMI-SI-1708	Haemostatic Forceps Pean (Rochester) 24 cm / 9 4/8"
1480	HMI-SI-1709	Haemostatic Forceps Pean (Rochester) 26 cm / 10 2/8"
1481	HMI-SI-1710	Haemostatic Forceps Pean (Rochester) 30,5 cm / 12"
1482	HMI-SI-1711	Haemostatic Forceps Kocher (Ochsner) 14,5 cm / 5 6/8"
1483	HMI-SI-1712	Haemostatic Forceps Kocher (Ochsner) 16,5 cm / 6 4/8"
1484	HMI-SI-1713	Haemostatic Forceps Kocher (Ochsner) 18,5 cm / 7 2/8"
1485	HMI-SI-1714	Haemostatic Forceps Kocher (Ochsner) 20,5 cm / 8 1/8"
1486	HMI-SI-1715	Haemostatic Forceps Kocher (Ochsner) 22,5 cm / 8 7/8"
1487	HMI-SI-1716	Haemostatic Forceps Kocher (Ochsner) 24 cm / 9 4/8"
1488	HMI-SI-1717	Haemostatic Forceps Kocher (Ochsner) 26 cm / 10 2/8"
1489	HMI-SI-1718	Haemostatic Forceps Kocher (Ochsner) 31 cm / 12 2/8"
1490	HMI-SI-1719	Haemostatic Forceps Kocher (Ochsner) 14 cm / 5 4/8"
1491	HMI-SI-1720	Haemostatic Forceps Kocher (Ochsner) 16,5 cm / 6 4/8"
1492	HMI-SI-1721	Haemostatic Forceps Kocher (Ochsner) 18,5 cm / 7 2/8"
1493	HMI-SI-1722	Haemostatic Forceps Kocher (Ochsner) 20,5 cm / 8 1/8"
1494	HMI-SI-1723	Haemostatic Forceps Kocher (Ochsner) 22,5 cm / 8 7/8"
1495	HMI-SI-1724	Haemostatic Forceps Kocher (Ochsner) 24 cm / 9 4/8"
1496	HMI-SI-1725	Haemostatic Forceps Kocher (Ochsner) 26 cm / 10 2/8"
1497	HMI-SI-1726	Haemostatic Forceps Kocher (Ochsner) 31 cm / 12 2/8"
1498	HMI-SI-1727	Dissecting and Ligature Forceps Overholt-Martin 18,5 cm / 7 2/8"









1499	HMI-SI-1728	Dissecting and Ligature Forceps Overholt-Martin 20,5 cm / 8 1/8"	
1500	HMI-SI-1729	Dissecting and Ligature Forceps Overholt-Martin 21cm / 8 2/8"	
1501	HMI-SI-1730	Dissecting and Ligature Forceps Overholt-Martin 21,5 cm / 8 2/8"	
1502	HMI-SI-1731	Dissecting and Ligature Forceps Overholt-Martin 24,5 cm / 9 6/8"	
1503	HMI-SI-1732	Dissecting and Ligature Forceps Mixer-Baby 18,5 cm / 7 2/8"	
1505	HMI-SI-1733	Dissecting and Ligature Forceps Adson-Baby 14,5 cm / 5 6/8"	
1506	HMI-SI-1734	Dissecting and Ligature Forceps Adson-Baby 18 cm / 7 1/8"	
1507	HMI-SI-1735	Dissecting and Ligature Forceps Heiss 21 cm / 8 2/8"	
1508	HMI-SI-1736	Dissecting and Ligature Forceps Heiss 20,5 cm / 8 1/8"	
1509	HMI-SI-1737	Dissecting and Ligature Forceps Heiss 21 cm / 8 2/8"	
			





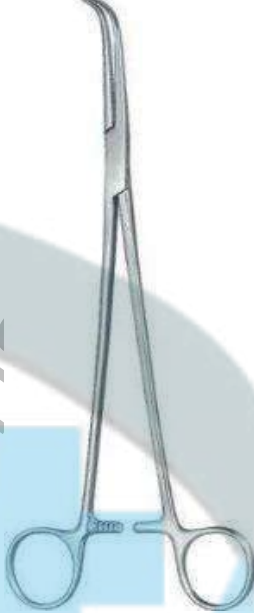

1510	HMI-SI-1738	Dissecting and Ligature Forceps Overholt-Mixer 22 cm / 8 5/8"	
1511	HMI-SI-1739	Dissecting and Ligature Forceps Roberts 22,5 cm / 8 7/8"	
1512	HMI-SI-1740	Dissecting and Ligature Forceps Roberts 22 cm / 8 5/8"	
1513	HMI-SI-1741	Dissecting and Ligature Forceps Sarot 25 cm / 9 7/8"	
1514	HMI-SI-1742	Dissecting and Ligature Forceps Sarot 24,5 cm / 9 5/8"	
1515	HMI-SI-1743	Dissecting and Ligature Forceps Crafoord 18,5 cm / 7 2/8"	
1516	HMI-SI-1744	Dissecting and Ligature Forceps Crafoord 24,5 cm / 9 5/8"	
1517	HMI-SI-1746	Dissecting and Ligature Forceps Crafoord-Sellors 24,5 cm / 9 5/8"	





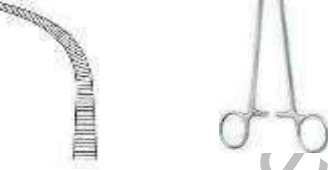



1518	HMI-SI-1747	Dissecting and Ligature Forceps Crafoord-Sellors 23 cm / 9"
1519	HMI-SI-1748	Dissecting and Ligature Forceps Crafoord-Sellors 22 cm / 8 5/8"
1520	HMI-SI-1749	Dissecting and Ligature Forceps Overholt-Geissendörfer 20,5 cm / 8 1/8"
1521	HMI-SI-1750	Dissecting and Ligature Forceps Overholt-Geissendörfer 20 cm / 7 7/8"
1522	HMI-SI-1751	Dissecting and Ligature Forceps Overholt-Geissendörfer 21,5 cm / 8 4/8"
1523	HMI-SI-1752	Dissecting and Ligature Forceps Overholt-Geissendörfer 22 cm / 8 5/8"
1524	HMI-SI-1753	Dissecting and Ligature Forceps Overholt-Geissendörfer 21,5 cm / 8 4/8"
1525	HMI-SI-1754	Dissecting and Ligature Forceps Overholt-Geissendörfer 21,5 cm / 8 2/8"
1526	HMI-SI-1755	Dissecting and Ligature Forceps Overholt-Geissendörfer 22 cm / 8 5/8"
1527	HMI-SI-1756	Dissecting and Ligature Forceps Overholt-Geissendörfer 27 cm / 10 5/8"
1528	HMI-SI-1757	Dissecting and Ligature Forceps Overholt-Geissendörfer 26,5 cm / 10 3/8"
1529	HMI-SI-1758	Dissecting and Ligature Forceps Overholt-Geissendörfer 27,5 cm / 10 7/8"







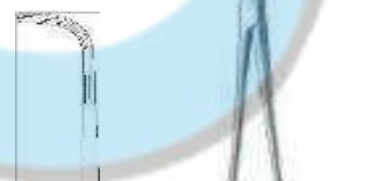





1530	HMI-SI-1759	Dissecting and Ligature Forceps Overholt-Geissendörfer 28 cm / 11"	
1531	HMI-SI-1760	Dissecting and Ligature Forceps Overholt-Geissendörfer 27,5 cm / 10 7/8"	
1532	HMI-SI-1761	Dissecting and Ligature Forceps Overholt-Geissendörfer 28 cm / 11"	
1533	HMI-SI-1762	Dissecting and Ligature Forceps Overholt-Geissendörfer 27,5 cm / 10 7/8"	
1534	HMI-SI-1763	Dissecting and Ligature Forceps Overholt-Fino 21,5 cm / 8 4/8"	
1535	HMI-SI-1764	Dissecting and Ligature Forceps Overholt-Fino 22 cm / 8 5/8"	
1536	HMI-SI-1765	Dissecting and Ligature Forceps Overholt-Fino 22,5 cm / 8 7/8"	
1537	HMI-SI-1766	Dissecting and Ligature Forceps Overholt-Fino 23 cm / 9"	
1538	HMI-SI-1767	Dissecting and Ligature Forceps Overholt-Fino 22,5 cm / 8 7/8"	
1539	HMI-SI-1768	Dissecting and Ligature Forceps Overholt 29,5 cm / 11 5/8"	
1540	HMI-SI-1769	Dissecting and Ligature Forceps Overholt 29,5 cm / 11 5/8"	
1541	HMI-SI-1770	Dissecting and Ligature Forceps Overholt 30 cm / 11 6/8"	





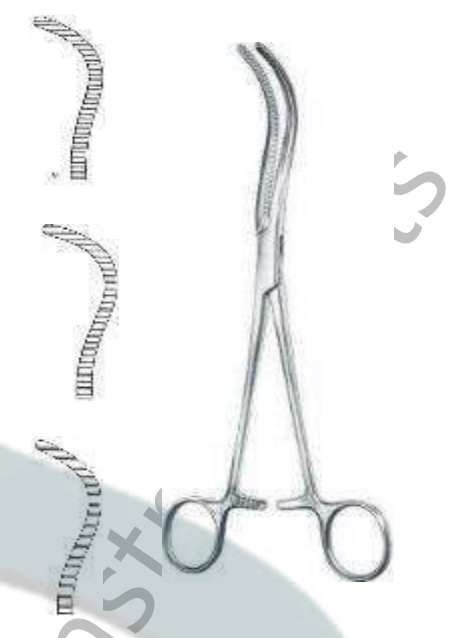
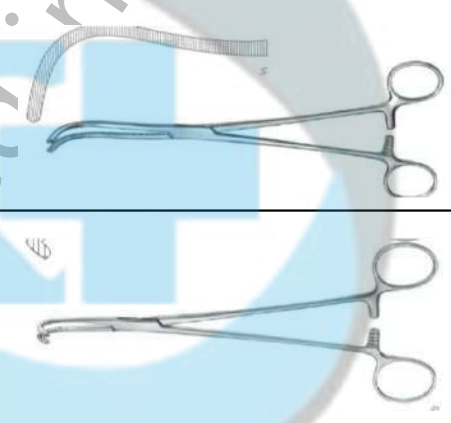

1542	HMI-SI-1771	Dissecting and Ligature Forceps Overholt-Mini 15 cm / 5 7/8"	
1543	HMI-SI-1772	Dissecting and Ligature Forceps Overholt-Mini 20 cm / 7 7/8"	
1544	HMI-SI-1773	Dissecting and Ligature Forceps Gemini 13 cm / 5 1/8"	
1545	HMI-SI-1774	Dissecting and Ligature Forceps Gemini 16 cm / 6 2/8"	
1546	HMI-SI-1775	Dissecting and Ligature Forceps Gemini 18 cm / 7 1/8"	
1547	HMI-SI-1776	Dissecting and Ligature Forceps Gemini 21 cm / 8 2/8"	
1548	HMI-SI-1777	Dissecting and Ligature Forceps Gemini 23 cm / 9"	
1549	HMI-SI-1778	Dissecting and Ligature Forceps Gemini 25 cm / 9 7/8"	
1550	HMI-SI-1779	Dissecting and Ligature Forceps Gemini 28 cm / 11"	
1551	HMI-SI-1780	Dissecting and Ligature Forceps Mini-Gemini 18 cm / 7 1/8"	
1552	HMI-SI-1781	Dissecting and Ligature Forceps Mini-Gemini 23 cm / 9 "	
1553	HMI-SI-1782	Dissecting and Ligature Forceps Mini-Gemini 25 cm / 9 7/8"	
1554	HMI-SI-1783	Dissecting and Ligature Forceps Mini-Gemini 28,5 cm / 11 2/8"	
1555	HMI-SI-1784	Dissecting and Ligature Forceps Rumel 24 cm / 9 4/8"	
1556	HMI-SI-1785	Dissecting and Ligature Forceps Rumel 24 cm / 9 4/8"	
1557	HMI-SI-1786	Dissecting and Ligature Forceps Rumel 23,5 cm / 9 2/8"	





1558	HMI-SI-1787	Dissecting and Ligature Forceps Rumel 24 cm / 9 4/8"	
1559	HMI-SI-1788	Dissecting and Ligature Forceps Rumel 24 cm / 9 4/8"	
1560	HMI-SI-1789	Dissecting and Ligature Forceps Zenker 29,5 cm / 11 5/8"	
1561	HMI-SI-1790	Dissecting and Ligature Forceps Zenker 28,5 cm / 11 2/8"	
1562	HMI-SI-1791	Dissecting and Ligature Forceps Mixer-Baby 13 cm / 5 1/8"	
1563	HMI-SI-1792	Dissecting and Ligature Forceps Mixer 16 cm / 6 2/8"	
1564	HMI-SI-1793	Dissecting and Ligature Forceps Mixer 17,5 cm / 6 7/8"	
1565	HMI-SI-1794	Dissecting and Ligature Forceps O'Shaugnessy 15 cm / 5 7/8"	
1566	HMI-SI-1795	Dissecting and Ligature Forceps O'Shaugnessy 18 cm / 7 1/8"	
1567	HMI-SI-1796	Dissecting and Ligature Forceps O'Shaugnessy 18,5 cm / 7 2/8"	
1568	HMI-SI-1797	Dissecting and Ligature Forceps O'Shaugnessy 20 cm / 7 7/8"	
1569	HMI-SI-1798	Dissecting and Ligature Forceps O'Shaugnessy 23 cm / 9"	

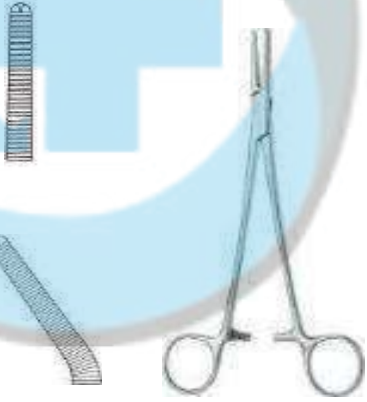

1570	HMI-SI-1799	Dissecting and Ligature Forceps O'Shaughnessy 26 cm / 10 2/8"	
1571	HMI-SI-1800	Dissecting and Ligature Forceps Mixer 22,5 cm / 8 7/8"	
1572	HMI-SI-1801	Dissecting and Ligature Forceps Mixer 23 cm / 9"	
1573	HMI-SI-1802	Dissecting and Ligature Forceps Wikstroem 21 cm / 8 2/8"	
1574	HMI-SI-1803	Dissecting and Ligature Forceps Wikstroem 24,5 cm / 9 5/8"	
1575	HMI-SI-1804	Dissecting and Ligature Forceps Mixer 22,5 cm / 8 6/8"	
1576	HMI-SI-1805	Dissecting and Ligature Forceps Mixer 26 cm / 10 2/8"	
1577	HMI-SI-1806	Dissecting and Ligature Forceps Mixer 28 cm / 11"	



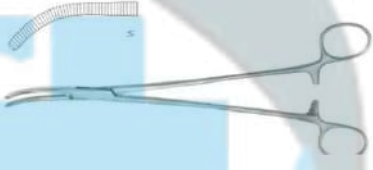
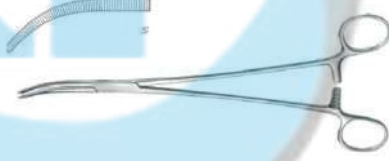

1578	HMI-SI-1807	Dissecting and Ligature Forceps McQuigg-Mixer 23,5 cm / 9 2/8"	
1579	HMI-SI-1808	Bile Duct Clamps, Dissecting and Ligature Forceps Lower 18,5 cm / 7 1/4"	
1580	HMI-SI-1809	Bile Duct Clamps, Dissecting and Ligature Forceps Lahey 19,5 cm / 7 5/8"	
1581	HMI-SI-1810	Bile Duct Clamps, Dissecting and Ligature Forceps Lahey 22,5 cm / 8 7/8"	
1582	HMI-SI-1811	Bile Duct Clamps, Dissecting and Ligature Forceps Finochietto 24,5 cm / 9 5/8"	
1583	HMI-SI-1812	Tangential Forceps, Kidney Pedicule Clamps Uro-Tangential 25 cm / 9 7/8"	
1584	HMI-SI-1813	Tangential Forceps, Kidney Pedicule Clamps Uro-Tangential 26 cm / 10 2/8"	
1585	HMI-SI-1814	Tangential Forceps, Kidney Pedicule Clamps Guyon 23 cm / 9"	

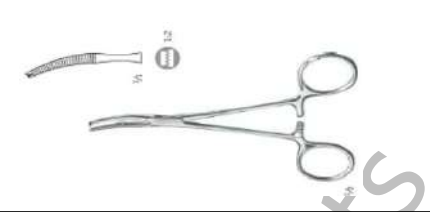
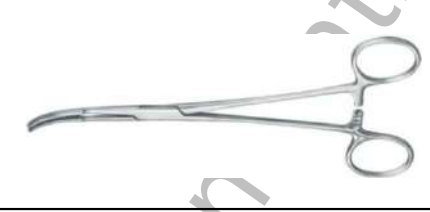
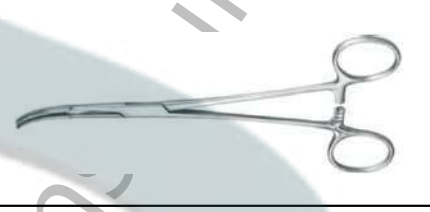
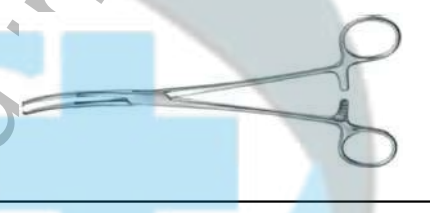
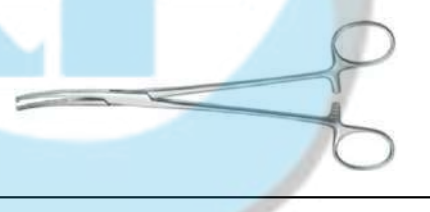



1586	HMI-SI-1815	Tangential Forceps, Kidney Pedicle Clamps Guyon 24 cm / 9 4/8"	
1587	HMI-SI-1816	Kidney Pedicle Clamps Guyon 19,5 cm / 7 5/8"	
1588	HMI-SI-1817	Kidney Pedicle Clamps Guyon 21,5 cm / 8 4/8"	
1589	HMI-SI-1818	Kidney Pedicle Clamps Guyon 24,5 cm / 9 5/8"	
1590	HMI-SI-1819	Kidney Pedicle Clamps Guyon 24 cm / 9 4/8"	
1591	HMI-SI-1820	Bile Duct Clamps Desjardins 21 cm / 8 2/8"	
1592	HMI-SI-1821	Dissecting and Ligature Forceps Kelly 19 cm / 7 4/8"	
1593	HMI-SI-1822	Dissecting and Ligature Forceps Kelly 22,5 cm / 8 7/8"	
1594	HMI-SI-1823	Dissecting and Ligature Forceps Kelly 23 cm / 9"	
1595	HMI-SI-1824	Dissecting and Ligature Forceps Kelly 19 cm / 7 4/8"	
1596	HMI-SI-1825	Dissecting and Ligature Forceps Kelly 22 cm / 8 5/8"	
1597	HMI-SI-1826	Dissecting and Ligature Forceps Kelly 23,5 cm / 9 2/8"	
1598	HMI-SI-1827	Dissecting and Ligature Forceps Kelly 18,5 cm / 7 2/8"	





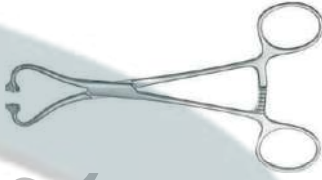

1599	HMI-SI-1828	Dissecting and Ligature Forceps Kelly 21,5 cm / 8 4/8"	
1600	HMI-SI-1829	Dissecting and Ligature Forceps Kelly 23 cm / 9"	
1601	HMI-SI-1830	Dissecting and Ligature Forceps, Haemostitic Forceps Lawrence 28 cm / 11"	
1602	HMI-SI-1831	Dissecting and Ligature Forceps, Haemostitic Forceps Meeker 28 cm / 11"	
1603	HMI-SI-1832	Dissecting and Ligature Forceps, Haemostitic Forceps Negus 19,5 cm / 7 5/8"	 
1604	HMI-SI-1833	Dissecting and Ligature Forceps, Haemostitic Forceps Negus 20 cm / 7 7/8"	
1605	HMI-SI-1834	Hysterectomy Forceps Phaneuf, 20,5 cm / 8 1/8"	 
1606	HMI-SI-1835	Hysterectomy Forceps Phaneuf 20 cm / 7 7/8"	
1607	HMI-SI-1836	Hysterectomy Forceps Heaney 19,5 cm / 7 5/8"	
1608	HMI-SI-1837	Hysterectomy Forceps Heaney 21,5 cm / 8 4/8"	
1609	HMI-SI-1838	Hysterectomy Forceps Heaney 24 cm / 9 4/8"	
1610	HMI-SI-1839	Hysterectomy Forceps Heaney 19,5 cm / 7 5/8"	
1611	HMI-SI-1840	Hysterectomy Forceps Heaney 21,5 cm / 8 4/8"	



1612	HMI-SI-1841	Hysterectomy Forceps Heaney 24 cm / 9 4/8"	
1613	HMI-SI-1842	Vaginal Clamp Wertheim-Cullen 21 cm / 8 2/8"	
1614	HMI-SI-1843	Hysterectomy Forceps Rogers 21,5 cm / 8 4/8"	
1615	HMI-SI-1844	Hysterectomy Forceps Rogers 21 cm / 8 2/8"	
1616	HMI-SI-1845	Hysterectomy Forceps Rogers 21 cm / 8 2/8"	
1617	HMI-SI-1846	Hysterectomy Forceps Rogers 20,5 cm / 8 1/8"	
1618	HMI-SI-1847	Hysterectomy Forceps Rogers 25,5 cm / 10"	
1619	HMI-SI-1848	Hysterectomy Forceps Rogers 25 cm / 9 7/8"	
1620	HMI-SI-1849	Hysterectomy Forceps Rogers 24,5 cm / 9 4/8"	
1621	HMI-SI-1850	Hysterectomy Forceps Rogers 24,5 cm / 9 4/8"	
1622	HMI-SI-1851	Bile Duct Clamps Moynihan 23 cm / 9"	
1623	HMI-SI-1852	Bile Duct Clamps Moynihan 23,5 cm / 9 2/8"	
1624	HMI-SI-1853	Hysterectomy Forceps Wertheim 26 cm / 10 2/8"	
1625	HMI-SI-1854	Hysterectomy Forceps Wertheim slightly curved 26 cm / 10 2/8"	

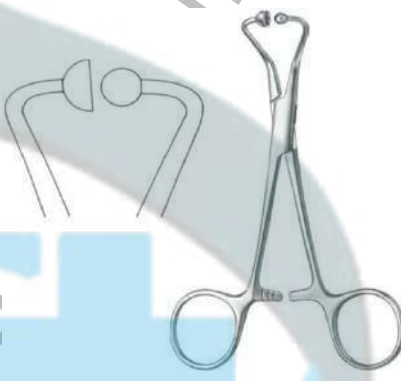



1626	HMI-SI-1855	Hysterectomy Forceps Wertheim stronger curved 26 cm / 10 2/8"	
1627	HMI-SI-1856	Peritoneum Forceps Mikulicz-Baby 14,5 cm / 5 6/8"	
1628	HMI-SI-1857	Peritoneum Forceps Mikulicz 18,5 cm / 7 2/8"	
1629	HMI-SI-1858	Peritoneum Forceps Mikulicz 20 cm / 7 7/8"	
1630	HMI-SI-1859	Peritoneum Forceps Mikulicz 20 cm / 7 7/8"	
1631	HMI-SI-1860	Peritoneum Forceps Mikulicz 20,5 cm / 8 1/8"	
1632	HMI-SI-1861	Peritoneum Forceps Faure 21 cm / 8 2/8"	
1633	HMI-SI-1862	Peritoneum Forceps Faure 21 cm / 8 2/8"	







1634	HMI-SI-1863	Towel Clamps Schädel 9 cm / 3 4/8"	
1635	HMI-SI-1864	Towel Clamps Jones 5,5 cm / 2 1/8"	
1636	HMI-SI-1865	Towel Clamps Jones 8,5 cm / 3 3/8"	
1637	HMI-SI-1866	Towel Clamps Jones-Martin 8,5 cm / 3 3/8"	
1638	HMI-SI-1867	Towel Clamps Backhaus 11 cm / 4 3/8"	
1639	HMI-SI-1868	Towel Clamps Backhaus 13 cm / 5 1/8"	
1640	HMI-SI-1869	Towel Clamps Backhaus 11 cm / 4 3/8"	
1641	HMI-SI-1870	Towel Clamps Backhaus 9 cm / 3 4/8"	







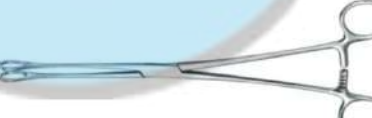

1642	HMI-SI-1871	Towel Clamps Backhaus 11 cm / 4 3/8"	
1643	HMI-SI-1872	Towel Clamps Backhaus 13 cm / 5 1/8"	
1644	HMI-SI-1873	Towel Clamps Backhaus 16 cm / 6 2/8"	
1645	HMI-SI-1874	Towel Clamps Peers-Bertram modif. 14,5 cm / 5 6/8"	
1646	HMI-SI-1875	Towel Clamps Roeder 13,5 cm / 5 3/8"	
1647	HMI-SI-1876	Towel Clamps Lorna 10 cm / 3 7/8"	
1648	HMI-SI-1877	Towel Clamps Lorna 13 cm / 5 1/8"	
1649	HMI-SI-1878	Towel Clamps Bernhard 16,5 cm / 6 4/8"	

















1650	HMI-SI-1879	Towel Clamps Tohoku 10,5 cm / 4 1/8"	
1651	HMI-SI-1880	Towel Clamps Tohoku 13,5 cm / 5 3/8"	
1652	HMI-SI-1881	Towel Clamps Peers-Bertram 14,5 cm / 5 6/8"	
1653	HMI-SI-1882	Towel Clamps for paper drapes 11,5 cm / 4 4/8"	
1654	HMI-SI-1883	Towel Clamps for paper drapes 14 cm / 5 4/8"	
1655	HMI-SI-1884	Towel Clamps Lane 19,5 cm / 7 5/8"	
1656	HMI-SI-1885	Towel Clamps extra long ratchet 14 cm / 5 4/8"	
1657	HMI-SI-1886	Towel Clamps smooth jaw 16,5 cm / 6 4/8"	





1658	HMI-SI-1887	Tubing Clamps 15,5 cm / 6 1/8"	
1659	HMI-SI-1888	Tubing Clamps 19 cm / 7 4/8"	
1660	HMI-SI-1889	Tubing Clamps 20,5 cm / 8 1/8"	
1661	HMI-SI-1890	Tubing Clamps with safety guard 15,5 cm / 6 1/8"	
1662	HMI-SI-1891	Tubing Clamps with safety guard 19 cm / 7 4/8"	
1663	HMI-SI-1892	Tubing Clamps with safety guard 20,5 cm / 8 1/8"	
1664	HMI-SI-1893	Tubing Clamps Brompton 16,5 cm / 6 4/8"	
1665	HMI-SI-1894	Tubing Clamps Gunnar-Hey 18 cm / 7 1/8"	







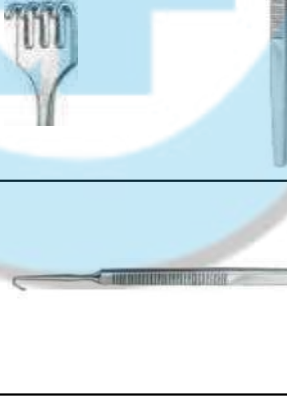



1666	HMI-SI-1895	Dressing Forceps Ulrich 22,5 cm / 8 7/8"	
1667	HMI-SI-1896	Dressing Forceps Ulrich 27 cm / 10 5/8"	
1668	HMI-SI-1897	Dressing Forceps Ulrich 22,5 cm / 8 7/8"	
1669	HMI-SI-1898	Dressing Forceps Ulrich 26,5 cm / 10 7/8"	
1670	HMI-SI-1899	Sinus Forceps, Dressing Forceps Lister 13 cm / 5 1/8"	
1671	HMI-SI-1900	Sinus Forceps, Dressing Forceps Lister 16 cm / 6 2/8"	
1672	HMI-SI-1901	Sinus Forceps, Dressing Forceps Lister 18,5 cm / 7 2/8"	
1673	HMI-SI-1902	Sinus Forceps, Dressing Forceps Martin 17,5 cm / 6 7/8"	
1674	HMI-SI-1903	Dressing Forceps Gross-Maier 20,5 cm / 8 1/8"	







1675	HMI-SI-1904	Dressing Forceps Gross-Maier 20,5 cm / 8 1/8"	
1676	HMI-SI-1905	Dressing Forceps Gross-Maier 22,5 cm / 8 7/8"	
1677	HMI-SI-1906	Dressing Forceps Gross-Maier 22,5 cm / 8 7/8"	
1678	HMI-SI-1907	Dressing Forceps Gross-Maier 26,5 cm / 10 3/8"	
1679	HMI-SI-1908	Dressing Forceps Gross-Maier 26,5 cm / 10 3/8"	
1680	HMI-SI-1909	Dressing Forceps Tunneling Forceps 39,5 cm / 15 4/8"	
1681	HMI-SI-1910	Dressing Forceps Collin 25 cm / 9 7/8"	
1682	HMI-SI-1911	Dressing Forceps Cheron 25 cm / 9 7/8"	
1683	HMI-SI-1912	Dressing Forceps Bozemann 26 cm / 10 2/8"	
1684	HMI-SI-1913	Sponge Forceps Bergmann 24 cm / 9 4/8"	
1685	HMI-SI-1914	Sponge Forceps Förster 25 cm / 9 7/8"	
1686	HMI-SI-1915	Sponge Forceps Förster 18 cm / 7 1/8"	
1687	HMI-SI-1916	Sponge Forceps Förster 20,5 cm / 8 1/8"	
1688	HMI-SI-1917	Sponge Forceps Förster 25 cm / 9 7/8"	
1689	HMI-SI-1918	Sponge Forceps Förster 24,5 cm / 9 5/8"	

















1690	HMI-SI-1919	Sponge Forceps Förster 18 cm / 7 1/8"	
1691	HMI-SI-1920	Sponge Forceps Förster 20,5 cm / 8 1/8"	
1692	HMI-SI-1921	Sponge Forceps Förster 24,5 cm / 9 5/8"	
1693	HMI-SI-1922	Sponge Forceps Förster 25 cm / 9 7/8"	
1694	HMI-SI-1923	Sponge Forceps Förster 25 cm / 9 7/8"	
1695	HMI-SI-1924	Sponge Forceps Rampley 18 cm / 7 1/8"	
1696	HMI-SI-1925	Sponge Forceps Rampley 24,5 cm / 9 5/8"	
1697	HMI-SI-1926	Micro Hooklets, Skin Hooks Rasse 16 cm / 6 2/8"	
1698	HMI-SI-1927	Micro Hooklets, Skin Hooks Graefe 15 cm / 5 7/8" sharp	 
1699	HMI-SI-1928	Micro Hooklets, Skin Hooks Graefe 15 cm / 5 7/8" blunt	
1700	HMI-SI-1929	Micro Hooklets, Skin Hooks sharp 16 cm / 6 2/8"	 









1701	HMI-SI-1930	Micro Hooklets, Skin Hooks sharp 16 cm / 6 2/8"		
1702	HMI-SI-1931	Micro Hooklets, Skin Hooks sharp 16 cm / 6 2/8"		
1703	HMI-SI-1932	Micro Hooklets, Skin Hooks sharp 16 cm / 6 2/8"		
1704	HMI-SI-1933	Micro Hooklets, Skin Hooks Rasse 16 cm / 6 2/8"		
1705	HMI-SI-1934	Skin Hooks, Hooklets O'Connor sharp 16 cm / 6 2/8"		
1706	HMI-SI-1935	Skin Hooks, Hooklets Guthrie sharp 16 cm / 6 2/8"		
1707	HMI-SI-1936	Skin Hooks, Hooklets Guthrie sharp 16 cm / 6 2/8"		
1708	HMI-SI-1937	Skin Hooks, Hooklets Guthrie 16,5 cm / 6 4/8" Sharp		
1709	HMI-SI-1938	Skin Hooks, Hooklets Guthrie 16,5 cm / 6 4/8" Sharp		
1710	HMI-SI-1939	Skin Hooks, Hooklets Guthrie 16,5 cm / 6 4/8" Sharp		









1711	HMI-SI-1939(a)	Skin Hooks, Hooklets Guthrie 16,5 cm / 6 4/8" Sharp	
1712	HMI-SI-1940	Skin Hooks, Hooklets Guthrie 16,5 cm / 6 4/8" Blunt	
1713	HMI-SI-1941	Skin Hooks, Hooklets Guthrie 16,5 cm / 6 4/8" Blunt	
1714	HMI-SI-1942	Skin Hooks, Hooklets Guthrie 16,5 cm / 6 4/8" Blunt	
1715	HMI-SI-1943	Skin Hooks, Hooklets Guthrie 16,5 cm / 6 4/8" Blunt	
1716	HMI-SI-1944	Hooklets 15,5 cm / 6 1/8" exible, sharp	
1717	HMI-SI-1945	Hooklets 15,5 cm / 6 1/8" exible, sharp	
1718	HMI-SI-1946	Hooklets 15,5 cm / 6 1/8" exible, sharp	
1719	HMI-SI-1947	Hooklets 15,5 cm / 6 1/8" exible, blunt	
1720	HMI-SI-1948	Hooklets 15,5 cm / 6 1/8" exible, blunt	
1721	HMI-SI-1949	Hooklets 15,5 cm / 6 1/8" exible, blunt	
1722	HMI-SI-1950	Hooklets 16,5 cm / 6 4/8" sharp	
1723	HMI-SI-1951	Hooklets 16,5 cm / 6 4/8" blunt	
1724	HMI-SI-1952	Hooklets Vessel Hook 12 cm / 4 6/8"	
1725	HMI-SI-1953	Saddle Hooks Desmarres 8 mm	
1726	HMI-SI-1954	Saddle Hooks Desmarres 10 mm	
1727	HMI-SI-1955	Saddle Hooks Desmarres 12 mm	
1728	HMI-SI-1956	Saddle Hooks Desmarres 14 mm	

1729	HMI-SI-1957	Saddle Hooks Desmarres 16 mm		
1730	HMI-SI-1958	Saddle Hooks Desmarres 18 mm		
1731	HMI-SI-1959	Saddle Hooks 16 cm / 6 2/8" 12 mm		 
1732	HMI-SI-1960	Saddle Hooks 16 cm / 6 2/8" 16 mm		
1733	HMI-SI-1961	Saddle Hooks 16 cm / 6 2/8" 14 mm		
1734	HMI-SI-1962	Saddle Hooks 16 cm / 6 2/8" 18 mm		
1735	HMI-SI-1963	Saddle Hooks Langenbeck-Mini 16 cm / 6 2/8" 12 x 6 mm	 	
1736	HMI-SI-1964	Saddle Hooks Langenbeck-Mini 16 cm / 6 2/8" 20 x 6 mm		
1737	HMI-SI-1965	Saddle Hooks Langenbeck-Mini 16 cm / 6 2/8" 18 x 6 mm		







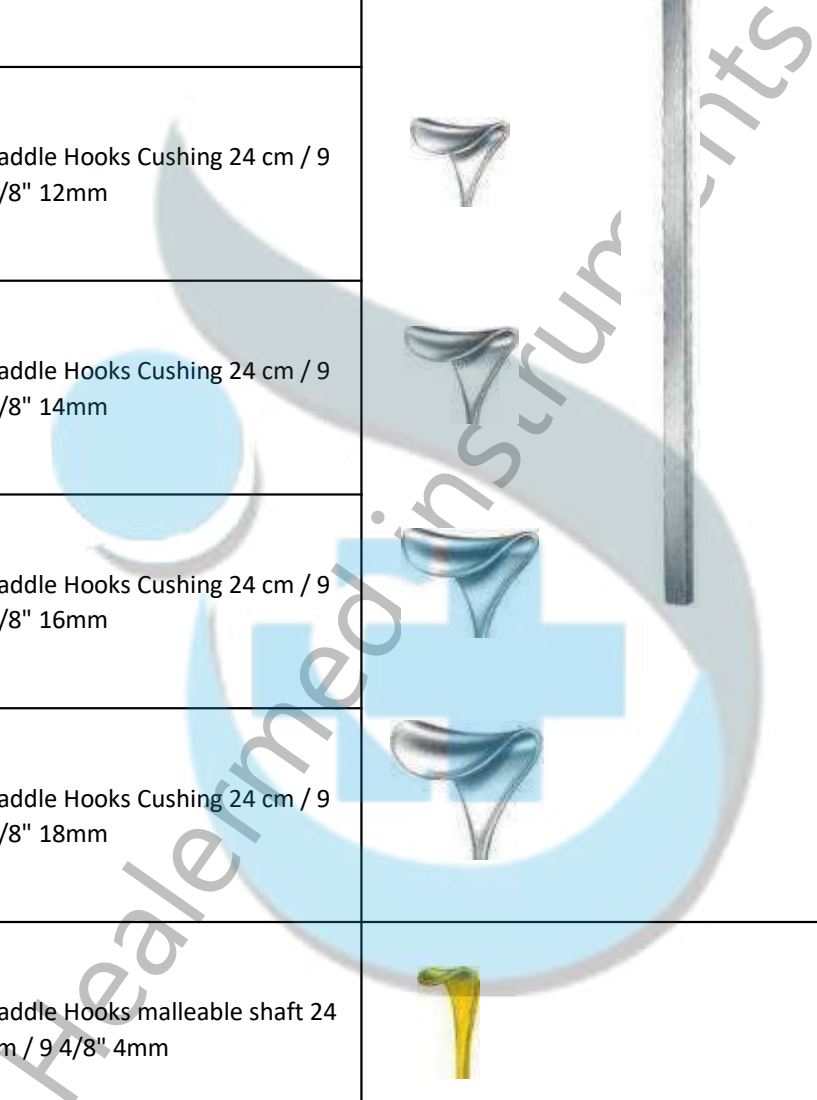

1738	HMI-SI-1966	Saddle Hooks Langenbeck-Mini 16 cm / 6 2/8" 21 x 8 mm	
1739	HMI-SI-1968	Hooklets 16 cm / 6 2/8" 14 x 8 mm	
1740	HMI-SI-1969	Hooklets 16,5 cm / 6 4/8" sharp	
1741	HMI-SI-1970	Hooklets 16,5 cm / 6 4/8" sharp	
1742	HMI-SI-1971	Hooklets 16,5 cm / 6 4/8" sharp	
1743	HMI-SI-1972	Hooklets 16,5 cm / 6 4/8" sharp	
1744	HMI-SI-1973	Hooklets 16,5 cm / 6 4/8" blunt	
1745	HMI-SI-1974	Hooklets 16,5 cm / 6 4/8" blunt	
1746	HMI-SI-1975	Hooklets 16,5 cm / 6 4/8" blunt	
1747	HMI-SI-1976	Hooklets 16,5 cm / 6 4/8" blunt	
1748	HMI-SI-1977	Hooklets Meyerding blunt 18 cm / 7 1/8"	
1749	HMI-SI-1978	Hooklets Meyerding toothed 18 cm / 7 1/8"	
1750	HMI-SI-1979	Hooklets Meyerding toothed 18 cm / 7 1/8"	



1751	HMI-SI-1980	Hooklets Meyerding blunt 18 cm / 7 1/8"		
1752	HMI-SI-1981	Hooklets Meyerding saddle shaped 18 cm / 7 1/8"		
1753	HMI-SI-1982	Hooklets Meyerding sharp 18 cm / 7 1/8"		
1754	HMI-SI-1983	Hooklets Senn-Green 16 cm / 6 2/8" 20 x 6 mm		
1755	HMI-SI-1984	Hooklets Senn-Green 16 cm / 6 2/8" 10 x 6 mm		
1756	HMI-SI-1985	Hooklets Ragnell-Davis 15 cm / 5 7/8" 8 x 4,5 mm		
1757	HMI-SI-1986	Hooklets Ragnell-Davis 15 cm / 5 7/8" 15 x 5,5 mm		
1758	HMI-SI-1987	Hooklets Senn-Miller sharp prongs 16 cm / 6 2/8"		







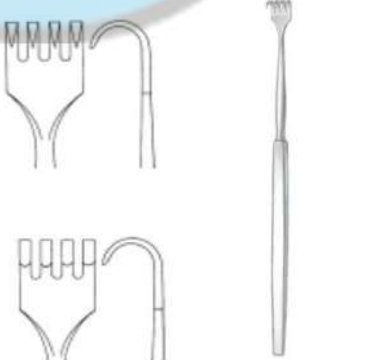

1759	HMI-SI-1988	Hooklets Senn-Miller blunt prongs 16 cm / 6 2/8"	 
1760	HMI-SI-1989	Hooklets Cushing 20,5 cm / 8 1/8"	
1761	HMI-SI-1990	Saddle Hooks Cushing 20,5 cm / 8 1/8" 8mm	
1762	HMI-SI-1991	Saddle Hooks Cushing 20,5 cm / 8 1/8" 10mm	
1763	HMI-SI-1992	Saddle Hooks Cushing 20,5 cm / 8 1/8" 12mm	
1764	HMI-SI-1993	Saddle Hooks Cushing 20,5 cm / 8 1/8" 14mm	
1765	HMI-SI-1994	Saddle Hooks Cushing 20,5 cm / 8 1/8" 16mm	
1766	HMI-SI-1995	Saddle Hooks Cushing 20,5 cm / 8 1/8" 18mm	

1767	HMI-SI-1996	Saddle Hooks Cushing 24 cm / 9 4/8" 8mm	
1768	HMI-SI-1997	Saddle Hooks Cushing 24 cm / 9 4/8" 10mm	
1769	HMI-SI-1998	Saddle Hooks Cushing 24 cm / 9 4/8" 12mm	
1770	HMI-SI-1998(a)	Saddle Hooks Cushing 24 cm / 9 4/8" 14mm	
1771	HMI-SI-1998(b)	Saddle Hooks Cushing 24 cm / 9 4/8" 16mm	
1772	HMI-SI-1998(c)	Saddle Hooks Cushing 24 cm / 9 4/8" 18mm	
1773	HMI-SI-1999(a)	Saddle Hooks malleable shaft 24 cm / 9 4/8" 4mm	
1774	HMI-SI-1999(b)	Saddle Hooks malleable shaft 24 cm / 9 4/8" 6mm	









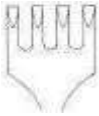

1775	HMI-SI-1999(c)	Saddle Hooks malleable shaft 24 cm / 9 4/8" 8mm		
1776	HMI-SI-1999(d)	Saddle Hooks malleable shaft 24 cm / 9 4/8" 11mm		
1777	HMI-SI-1999(e)	Saddle Hooks malleable shaft 24 cm / 9 4/8" 15mm		
1778	HMI-SI-1999(f)	Saddle Hooks malleable shaft 24 cm / 9 4/8" 17mm		
1779	HMI-SI-1999(g)	Saddle Hooks malleable shaft 24 cm / 9 4/8" 20mm		
1780	HMI-SI-2000	Saddle Hooks malleable shaft 24 cm / 9 4/8" 23mm		
1780	HMI-SI-2001	Vein Hooks Brom 19 cm / 7 4/8" narrow		
1782	HMI-SI-2002	Vein Hooks Brom 19 cm / 7 4/8" wide		

1783	HMI-SI-2003	Vein Hooks Strandell-Stille smooth blade end 19 cm / 7 4/8"	
1784	HMI-SI-2004	Vein Hooks Strandell-Stille toothed blade end 19 cm / 7 4/8"	
1785	HMI-SI-2005	Vein Hooks Strandell-Stille Kaye-Millard sharp 8 cm / 3 1/8"	
1786	HMI-SI-2006	Retractors Klapp 17,5 cm / 6 7/8" blunt 13 x 6 mm	
1787	HMI-SI-2006(a)	Retractors Klapp 17,5 cm / 6 7/8" blunt 12 x 11 mm	
1788	HMI-SI-2007	Retractors Klapp 17,5 cm / 6 7/8" blunt 15 x 12 mm	
1789	HMI-SI-2008	Retractors Klapp 16,5 cm / 6 4/8" sharp	
1790	HMI-SI-2009	Retractors Klapp 16,5 cm / 6 4/8" blunt	





1791	HMI-SI-2010	Retractors Volkman 21,5 cm / 8 4/8" sharp	
1792	HMI-SI-2011	Retractors Volkman 21,5 cm / 8 4/8" sharp	
1793	HMI-SI-2012	Retractors Volkman 21,5 cm / 8 4/8" sharp	
1794	HMI-SI-2013	Retractors Volkman 21,5 cm / 8 4/8" sharp	
1795	HMI-SI-2014	Retractors Volkman 21,5 cm / 8 4/8" sharp	
1796	HMI-SI-2015	Retractors Volkman 21,5 cm / 8 4/8" blunt	
1797	HMI-SI-2016	Retractors Volkman 21,5 cm / 8 4/8" blunt	
1798	HMI-SI-2017	Retractors Volkman 21,5 cm / 8 4/8" blunt	



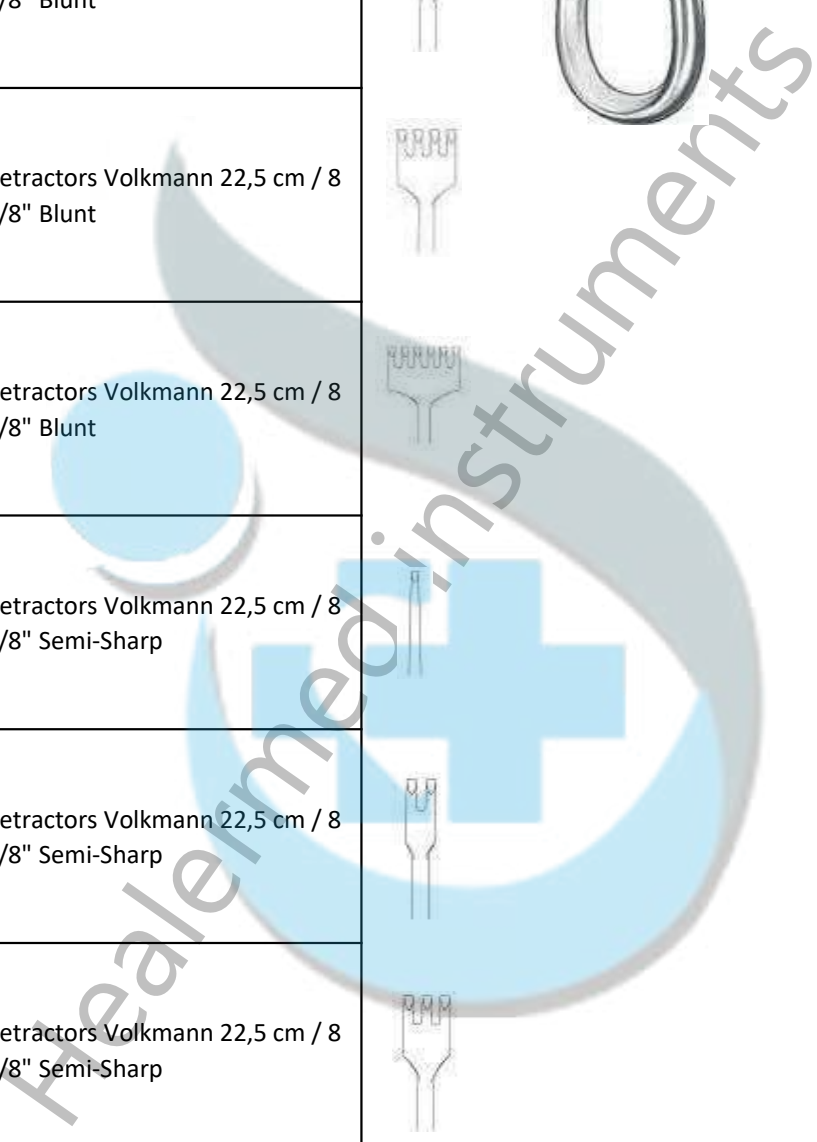





1799	HMI-SI-2018	Retractors Volkman 21,5 cm / 8 4/8" blunt	
1800	HMI-SI-2019	Retractors Volkman 21,5 cm / 8 4/8" blunt	
1801	HMI-SI-2020(a)	Retractors Volkman 22,5 cm / 8 7/8" Sharp	
1802	HMI-SI-2020(b)	Retractors Volkman 22,5 cm / 8 7/8" Sharp	
1803	HMI-SI-2020©	Retractors Volkman 22,5 cm / 8 7/8" Sharp	
1804	HMI-SI-2020(d)	Retractors Volkman 22,5 cm / 8 7/8" Sharp	
1805	HMI-SI-2020(e)	Retractors Volkman 22,5 cm / 8 7/8" Sharp	
1806	HMI-SI-2020(f)	Retractors Volkman 22,5 cm / 8 7/8" Blunt	 

1807	HMI-SI-2021	Retractors Volkmann 22,5 cm / 8 7/8" Blunt
1807	HMI-SI-2022	Retractors Volkmann 22,5 cm / 8 7/8" Blunt
1807	HMI-SI-2023	Retractors Volkmann 22,5 cm / 8 7/8" Blunt
1807	HMI-SI-2024	Retractors Volkmann 22,5 cm / 8 7/8" Blunt
1808	HMI-SI-2025	Retractors Volkmann 22,5 cm / 8 7/8" Semi-Sharp
1809	HMI-SI-2026	Retractors Volkmann 22,5 cm / 8 7/8" Semi-Sharp
1810	HMI-SI-2027	Retractors Volkmann 22,5 cm / 8 7/8" Semi-Sharp
1811	HMI-SI-2028	Retractors Volkmann 22,5 cm / 8 7/8" Semi-Sharp











1812	HMI-SI-2029	Retractors Volkmann 22,5 cm / 8 7/8" Semi-Sharp	
1813	HMI-SI-2030	Retractors Volkmann Sharp 21,5 cm / 8 4/8"	
1814	HMI-SI-2031	Retractors Volkmann Blunt 21,5 cm / 8 4/8"	
1815	HMI-SI-2032	Retractors 21,5 cm / 8 4/8" Sharp	
1816	HMI-SI-2033(a)	Retractors Kocher 22,5 cm / 8 7/8" sharp	
1817	HMI-SI-2033(b)	Retractors Kocher 22,5 cm / 8 7/8" sharp	
1818	HMI-SI-2033(c)	Retractors Kocher 22,5 cm / 8 7/8" sharp	
1819	HMI-SI-2033(d)	Retractors Kocher 22,5 cm / 8 7/8" sharp	
1820	HMI-SI-2033(e)	Retractors Kocher 22,5 cm / 8 7/8" sharp	
1821	HMI-SI-2033(f)	Retractors Kocher 22,5 cm / 8 7/8" sharp	
1822	HMI-SI-2033(g)	Retractors Kocher 22,5 cm / 8 7/8" blunt	
1823	HMI-SI-2034	Retractors Kocher 22,5 cm / 8 7/8" blunt	
1824	HMI-SI-2035	Retractors Kocher 22,5 cm / 8 7/8" blunt	

1824	HMI-SI-2036	Retractors Kocher 22,5 cm / 8 7/8" blunt	
1824	HMI-SI-2037	Retractors Kocher 22,5 cm / 8 7/8" blunt	
1825	HMI-SI-2038	Retractors Kocher 22,5 cm / 8 7/8" blunt	
1826	HMI-SI-2039	Retractors Kocher 22,5 cm / 8 7/8" semi-sharp	
1827	HMI-SI-2040	Retractors Kocher 22,5 cm / 8 7/8" semi-sharp	
1828	HMI-SI-2041	Retractors Kocher 22,5 cm / 8 7/8" semi-sharp	
1829	HMI-SI-2042	Retractors Kocher 22,5 cm / 8 7/8" semi-sharp	
1830	HMI-SI-2043	Retractors Kocher 22,5 cm / 8 7/8" semi-sharp	
1831	HMI-SI-2044	Retractors Kocher 22,5 cm / 8 7/8" semi-sharp	
1832	HMI-SI-2045	Retractors Martin 22,5 cm / 8 7/8" sharp	
1833	HMI-SI-2046	Retractors Martin 22,5 cm / 8 7/8" sharp	
1834	HMI-SI-2047	Retractors Martin 22,5 cm / 8 7/8" sharp	
1835	HMI-SI-2048	Retractors Martin 22,5 cm / 8 7/8" sharp	
1836	HMI-SI-2049	Retractors Martin 22,5 cm / 8 7/8" blunt	
1837	HMI-SI-2050	Retractors Martin 22,5 cm / 8 7/8" blunt	
1838	HMI-SI-2051	Retractors Martin 22,5 cm / 8 7/8" blunt	
1839	HMI-SI-2052	Retractors Martin 22,5 cm / 8 7/8" blunt	
1840	HMI-SI-2053	Retractors Ollier 24,5 cm / 9 5/8" Blunt	
1841	HMI-SI-2054	Retractors Ollier 23 cm / 9" Blunt	

1842	HMI-SI-2055	Retractors Wassmund 20,5 cm / 8 1/8"	
1843	HMI-SI-2056	Retractors Körte 24,5 cm / 9 5/8" 25 x 40 mm Sharp	
1844	HMI-SI-2057	Retractors Körte 24,5 cm / 9 5/8" 25 x 40 mm blunt	
1845	HMI-SI-2058	Retractors Israel blunt 24,5 cm / 9 5/8" 40 x 40 mm	
1846	HMI-SI-2059	Retractors Israel blunt 24,5 cm / 9 5/8" 45 x 50 mm	
1847	HMI-SI-2060	Retractors Israel blunt 24,5 cm / 9 5/8" 50 x 60 mm	
1848	HMI-SI-2061	Retractors Israel blunt 24,5 cm / 9 5/8" 70 x 70 mm	
1849	HMI-SI-2062	Retractors Langenbeck 22 cm / 8 5/8" 30 x 11 mm	





1850	HMI-SI-2063	Retractors Langenbeck 22 cm / 8 5/8" 30 x 14 mm
1851	HMI-SI-2064	Retractors Langenbeck 22 cm / 8 5/8" 30 x 15 mm
1852	HMI-SI-2065	Retractors Langenbeck 22 cm / 8 5/8" 40 x 11 mm
1853	HMI-SI-2066	Retractors Langenbeck 22 cm / 8 5/8" 50 x 11 mm
1854	HMI-SI-2067	Retractors Langenbeck 22 cm / 8 5/8" 30 x 11 mm
1855	HMI-SI-2068	Retractors Langenbeck 22 cm / 8 5/8" 30 x 14 mm
1856	HMI-SI-2069	Retractors Langenbeck 22 cm / 8 5/8" 30 x 15 mm
1857	HMI-SI-2070	Retractors Langenbeck 22 cm / 8 5/8" 40 x 11 mm













1858	HMI-SI-2071	Retractors Langenbeck 22 cm / 8 5/8" 50 x 11 mm	
1859	HMI-SI-2072	Retractors Langenbeck 21 cm / 8 2/8" 60 x 20 mm	
1860	HMI-SI-2073	Retractors Langenbeck 21 cm / 8 2/8" 43 x 13 mm	
1861	HMI-SI-2074	Retractors Langenbeck 22,5 cm / 8 7/8" 85 x 15 mm	
1862	HMI-SI-2076	Retractors Langenbeck-Green 16 cm / 6 2/8" 6 x 16 mm	
1863	HMI-SI-2077	Retractors Langenbeck-Green 16 cm / 6 2/8" 6 x 25 mm	
1864	HMI-SI-2078	Retractors Lahey 19,5 cm / 7 5/8" 29 x 6 mm	
1865	HMI-SI-2079	Retractors Little 20,5 cm / 8 1/8" 13 x 15 mm	
1866	HMI-SI-2080	Retractors Kocher 23 cm / 9" 41 x 18 mm	







1867	HMI-SI-2081	Retractors Kocher 23 cm / 9 " 61 x 20 mm
1868	HMI-SI-2082	Retractors Kocher 23 cm / 9 " 61 x 25 mm
1869	HMI-SI-2083	Retractors Kocher 23 cm / 9 " 75 x 30 mm
1870	HMI-SI-2084	Retractors Kocher 23 cm / 9 " 75 x 40 mm
1871	HMI-SI-2085	Retractors Kocher-Langenbeck 21,5 cm / 8 4/8" 25 x 6 mm
1872	HMI-SI-2086	Retractors Kocher-Langenbeck 21,5 cm / 8 4/8" 35 x 8 mm
1873	HMI-SI-2087	Retractors Kocher-Langenbeck 21,5 cm / 8 4/8" 35 x 11 mm
1874	HMI-SI-2088	Retractors Kocher-Langenbeck 21,5 cm / 8 4/8" 35 x 15 mm
1875	HMI-SI-2089	Retractors Kocher-Langenbeck 21,5 cm / 8 4/8" 40 x 11 mm
1876	HMI-SI-2090	Retractors Kocher-Langenbeck 21,5 cm / 8 4/8" 55 x 11 mm
1877	HMI-SI-2091	Retractors Kocher-Langenbeck 21,5 cm / 8 4/8" 70 x 14 mm
1878	HMI-SI-2092	Retractors Kocher-Langenbeck 21,5 cm / 8 4/8" 80 x 13 mm
1879	HMI-SI-2093	Retractors Kocher-Langenbeck 21,5 cm / 8 4/8" 80 x 16 mm
1880	HMI-SI-2094	Retractors Kocher-Langenbeck 21,5 cm / 8 4/8" 25 x 10 mm
1881	HMI-SI-2095	Retractors Kocher-Langenbeck 21,5 cm / 8 4/8" 40 x 13 mm
1882	HMI-SI-2096	Retractors Kocher-Langenbeck 21,5 cm / 8 4/8" 60 x 13 mm
1883	HMI-SI-2097	Retractors Kocher-Langenbeck 21,5 cm / 8 4/8" 40 x 18 mm
1884	HMI-SI-2098	Retractors Kocher-Langenbeck 21,5 cm / 8 4/8" 60 x 18 mm













1885	HMI-SI-2099	Retractors Kocher-Langenbeck 21,5 cm / 8 4/8" 85 x 18 mm	
1886	HMI-SI-2100	Retractors Kocher-Langenbeck 21,5 cm / 8 4/8" 60 x 25 mm	
1887	HMI-SI-2101	Retractors Kocher-Langenbeck 21,5 cm / 8 4/8" 85 x 25 mm	
1888	HMI-SI-2102	Retractors Mini-Zenker 18 cm / 7" 10 x 3 mm	
1889	HMI-SI-2103	Retractors Zenker 25 cm / 9 3/4" 35 x 9 mm	
1890	HMI-SI-2104	Retractors Zenker 26,5 cm / 10 2/8" 60 x 12 mm	
1891	HMI-SI-2105	Retractors Zenker 27,5 cm / 10 6/8" 75 x 12 mm	
1892	HMI-SI-2106	Retractors Zenker 28,5 cm / 11 2/8" 85 x 20 mm	
1893	HMI-SI-2107	Retractors Zenker 30,5 cm / 12" 100 x 25 mm	
1894	HMI-SI-2108	Retractors Kocher 21,5 cm / 8 4/8" 20 x 12 mm	
1895	HMI-SI-2109	Retractors Kocher 21,5 cm / 8 4/8" 23 x 14 mm	
1896	HMI-SI-2110	Retractors Kocher 22 cm / 8 5/8" 40 x 10 mm	
1897	HMI-SI-2111	Retractors Kocher 23 cm / 9" 40 x 15 mm	



1898	HMI-SI-2112	Retractors Kocher 23 cm / 9" 40 x 20 mm	
1899	HMI-SI-2113	Retractors Middeldorpf 22 cm / 8 5/8" 15 x 17 mm	
1900	HMI-SI-2114	Retractors Middeldorpf 23 cm / 9" 22 x 22 mm	
1901	HMI-SI-2115	Retractors Middeldorpf 24 cm / 9 4/8" 26 x 31 mm	
1902	HMI-SI-2116	Retractors Richardson-Eastman 27,5 cm / 10 7/8" 25 x 20 mm 43 x 38 mm	
1903	HMI-SI-2117	Retractors Richardson-Eastman 27,5 cm / 10 7/8" 30 x 28 mm 63 x 44 mm	
1904	HMI-SI-2118	Retractors Richardson 23,5 cm / 9 2/8" 25 x 21 mm	
1905	HMI-SI-2119	Retractors Richardson 24 cm / 9 4/8" 30 x 29 mm	







1906	HMI-SI-2120	Retractors Richardson 24 cm / 9 4/8" 38 x 40 mm	
1907	HMI-SI-2121	Retractors Richardson 24 cm / 9 4/8" 48 x 22 mm	
1908	HMI-SI-2122	Retractors Richardson 26 cm / 10 2/8" 62 x 50 mm	
1909	HMI-SI-2123	Retractors Doyen-Stille 25 cm / 9 7/8" 87 x 28 mm	
1910	HMI-SI-2124	Retractors Doyen-Stille 26 cm / 10 2/8" 97 x 31 mm	
1911	HMI-SI-2125	Retractors Doyen-Stille 26 cm / 10 2/8" 117 x 52 mm	
1912	HMI-SI-2126	Retractors Hösel 26 cm / 10 2/8" 63 x 21 mm	
1913	HMI-SI-2127	Retractors Hösel 26 cm / 10 2/8" 83 x 30 mm	
1914	HMI-SI-2128	Retractors Hösel 26 cm / 10 2/8" 100 x 30 mm	
1915	HMI-SI-2129	Retractors Hösel 26 cm / 10 2/8" 120 x 30 mm	
1916	HMI-SI-2130	Retractors Hösel 26 cm / 10 2/8" 140 x 30 mm	
1917	HMI-SI-2131	Retractors Hösel 26 cm / 10 2/8" 140 x 40 mm	









1918	HMI-SI-2132	Retractors Middeldorpf 27 cm / 10 5/8" 43 x 45 mm	
1919	HMI-SI-2133	Retractors Middeldorpf 27 cm / 10 5/8" 52 x 50 mm	
1920	HMI-SI-2134	Retractors Middeldorpf 28 cm / 11" 52 x 70 mm	
1921	HMI-SI-2135	Retractors Fritsch 23,5 cm / 9 2/8" 35 x 31 mm	
1922	HMI-SI-2136	Retractors Fritsch 24 cm / 9 4/8" 33 x 40 mm	
1923	HMI-SI-2137	Retractors Fritsch 25 cm / 9 6/8" 39 x 50 mm	
1924	HMI-SI-2138	Retractors Fritsch 25 cm / 9 6/8" 45 x 63 mm	
1925	HMI-SI-2139	Retractors Fritsch 25,5 cm / 10" 45 x 75 mm	
1926	HMI-SI-2140	Retractors Fritsch 25,5 cm / 10" 53 x 85 mm	
1927	HMI-SI-2141	Retractors Doyen 24 cm / 9 4/8" 45 x 88 mm	
1928	HMI-SI-2142	Retractors Doyen 23,5 cm / 9 2/8" 70 x 25 mm	
1929	HMI-SI-2143	Retractors Kocher 25 cm / 9 7/8" 78 x 45 mm	





1930	HMI-SI-2144	Retractors Kocher 25 cm / 9 7/8" 78 x 55 mm	
1931	HMI-SI-2145	Retractors Kocher 25 cm / 9 7/8" 78 x 65 mm	
1932	HMI-SI-2147	Retractors Martin 26,5 cm / 10 3/8" 110 x 27 mm	
1933	HMI-SI-2148	Retractors Simon 28 cm / 11" 115 x 22 mm	
1934	HMI-SI-2149	Retractors Simon 28 cm / 11" 115 x 28 mm	
1935	HMI-SI-2150	Retractors Coryllos 24 cm / 9 4/8" 119 x 65 mm	
1936	HMI-SI-2151	Retractors Coryllos 24 cm / 9 4/8" 108 x 43 mm	
1937	HMI-SI-2152	Retractors Coryllos 24 cm / 9 4/8" 80 x 22 mm	





1938	HMI-SI-2153	Scapula Retractors Davidson 19 cm / 7 4/8" 80 x 54 mm	
1939	HMI-SI-2154	Scapula Retractors Davidson 18,5 cm / 7 2/8" 75 x 93 mm	
1940	HMI-SI-2155	Retractors Sauerbruch 25,5 cm / 10 " 125 x 38 mm	
1941	HMI-SI-2156	Retractors Brunner 25,5 cm / 10 " 180 x 30 mm	
1942	HMI-SI-2157	Retractors Brunner 25,5 cm / 10 " 160 x 30 mm	
1943	HMI-SI-2158	Retractors Brunner 25,5 cm / 10 " 140 x 30 mm	
1944	HMI-SI-2159	Retractors Brunner 25,5 cm / 10 " 130 x 30 mm	
1945	HMI-SI-2160	Retractors Brunner 25,5 cm / 10 " 120 x 25 mm	
1946	HMI-SI-2161	Retractors Brunner 25,5 cm / 10 " 100 x 25 mm	
1947	HMI-SI-2162	Retractors Brunner 25,5 cm / 10 " 80 x 20 mm	
1948	HMI-SI-2163	Retractors Brunner 25,5 cm / 10 " 180 x 30 mm	
1949	HMI-SI-2164	Retractors Brunner 25,5 cm / 10 " 160 x 30 mm	
1950	HMI-SI-2165	Retractors Brunner 25,5 cm / 10 " 140 x 25 mm	
1951	HMI-SI-2166	Retractors Brunner 25,5 cm / 10 " 120 x 25 mm	
1952	HMI-SI-2167	Retractors Brunner 25,5 cm / 10 " 100 x 20 mm	
1953	HMI-SI-2168	Retractors Brunner 25,5 cm / 10 " 80 x 20 mm	
1954	HMI-SI-2169	Retractors Sauerbruch 22,5 cm / 8 7/8" 45 x 15 mm	





1955	HMI-SI-2170	Retractors Sauerbruch 22,5 cm / 8 7/8" 60 x 23 mm	
1956	HMI-SI-2171	Retractors Sauerbruch 22,5 cm / 8 7/8" 72 x 20 mm	
1957	HMI-SI-2172	Aortic Valve Retractors Ross exible shaft 26,5 cm / 10 3/8" 13 x 16 mm	
1958	HMI-SI-2173	Aortic Valve Retractors Ross exible shaft 27 cm / 10 5/8" 11 x 22 mm	
1959	HMI-SI-2174	Aortic Valve Retractors Ross exible shaft 27 cm / 10 5/8" 15 x 23 mm	
1960	HMI-SI-2175	Aortic Valve Retractors Ross exible shaft 27,5 cm / 10 7/8" 12 x 28 mm	
1961	HMI-SI-2176	Aortic Valve Retractors Ross exible shaft 27,5 cm / 10 7/8" 27 x 27 mm	
1962	HMI-SI-2177	Aortic Valve Retractors Ross exible shaft 27,5 cm / 10 7/8" 38 x 24 mm	
1963	HMI-SI-2178	Aortic Valve Retractors Borowski 27 cm / 10 5/8" 17 x 21 mm	
1964	HMI-SI-2179	Aortic Valve Retractors Borowski 27 cm / 10 5/8" 16 x 23 mm	
1965	HMI-SI-2180	Aortic Valve Retractors Borowski 27 cm / 10 5/8" 20 x 25 mm	
1966	HMI-SI-2181	Aortic Valve Retractors Borowski 27 cm / 10 5/8" 24 x 27 mm	
1967	HMI-SI-2182	Aortic Valve Retractors Borowski 27 cm / 10 5/8" 28 x 20 mm	
1968	HMI-SI-2183	Aortic Valve Retractors Borowski 27 cm / 10 5/8" 28 x 29 mm	







1969	HMI-SI-2184	Retractors Polloson 29 cm / 11 3/8"	
1970	HMI-SI-2185	Retractors Polloson 26 cm / 10 4/8"	
1971	HMI-SI-2186	Retractors Harrington 32,5 cm / 12 6/8" 137 x 44 mm	
1972	HMI-SI-2187	Retractors Harrington 33 cm / 13 " 137 x 65 mm	
1973	HMI-SI-2188	Retractors Deaver 18 cm / 7 1/8" 16 mm	
1974	HMI-SI-2189	Retractors Deaver 18 cm / 7 1/8" 19 mm	
1975	HMI-SI-2190	Retractors Deaver 21,5 cm / 8 4/8" 22 mm	
1976	HMI-SI-2191	Retractors Deaver 26 cm / 10 2/8" 25 mm	



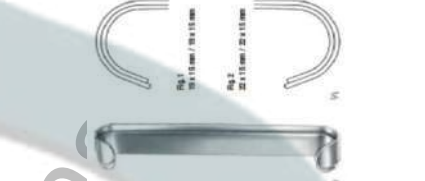
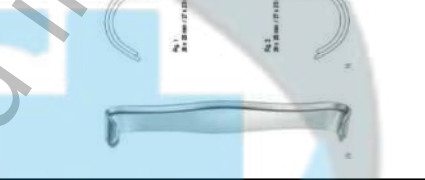

1977	HMI-SI-2192	Retractors Deaver 30,5 cm / 12 " 25 mm	
1978	HMI-SI-2193	Retractors Deaver 33,5 cm / 13 2/8" 25 mm	
1979	HMI-SI-2194	Retractors Deaver 34,5 cm / 13 5/8" 25 mm	
1980	HMI-SI-2195	Retractors Deaver 32 cm / 12 5/8" 38 mm	
1981	HMI-SI-2196	Retractors Deaver 31,5 cm / 12 3/8" 50 mm	
1982	HMI-SI-2197	Retractors Deaver 31,5 cm / 12 3/8" 75 mm	
1983	HMI-SI-2198	Retractors Deaver 31,5 cm / 12 3/8" 25 mm	
1984	HMI-SI-2199	Retractors Deaver 31,5 cm / 12 3/8" 38 mm	





1985	HMI-SI-2200	Retractors Deaver 31,5 cm / 12 3/8" 50 mm	
1986	HMI-SI-2201	Retractors Deaver 32,5 cm / 12 6/8" 100 mm	
1987	HMI-SI-2202	Atrium Retractors Cooley right 25 cm / 9 7/8" 48 x 48 mm	
1988	HMI-SI-2203	Atrium Retractors Cooley right, serrated 25 cm / 9 7/8" 48 x 48 mm	
1989	HMI-SI-2204	Atrium Retractors Cooley left 27,5 cm / 10 7/8" 30 x 48 mm	
1990	HMI-SI-2205	Retractors Mikulicz 25 cm / 9 7/8" 160 x 50 mm	
1991	HMI-SI-2206	Retractors Mikulicz 25 cm / 9 7/8" 125 x 50 mm	
1992	HMI-SI-2207	Retractors Mikulicz 25 cm / 9 7/8" 90 x 35 mm	



1993	HMI-SI-2208	Retractors Mikulicz 26 cm / 10 7/8" 85 x 55 mm	
1994	HMI-SI-2209	Retractors Kelly 27,5 cm / 10 7/8" 205 x 38 mm	
1995	HMI-SI-2210	Retractors Kelly 28 cm / 11 " 210 x 57 mm	
1996	HMI-SI-2211	Pelvis Retractors St. Marks 26 cm / 10 7/8" 130 x 60 mm 35 x 45 mm	
1997	HMI-SI-2212	Pelvis Retractors St. Marks 23,5 cm / 9 2/8" 180 x 60 mm 60 x 45 mm	
1998	HMI-SI-2213	Pelvis Retractors St. Marks 28 cm / 11 " 180 x 60 mm 60 x 45 mm	
1999	HMI-SI-2214	Abdominal Spatulas Kümmel 31 cm / 12 2/8" 45 mm	
2000	HMI-SI-2215	Abdominal Spatulas Kader 28 cm / 11 " 20 mm	





2001	HMI-SI-2216	Abdominal Spatulas Kader 28 cm / 11 " 30 mm	
2002	HMI-SI-2217	Abdominal Spatulas Kader 28 cm / 11 " 40 mm	
2003	HMI-SI-2218	Retractors Collin-Hartmann 15 cm / 5 7/8" 50 x 35 mm 35 x 29 mm	
2004	HMI-SI-2219	Retractors Roux 17 cm / 6 6/8"	
2005	HMI-SI-2219(a)	Retractors Roux 14,5 cm / 5 6/8"	
2006	HMI-SI-2220	Retractors Roux 16 cm / 6 2/8"	
2007	HMI-SI-2221	Retractors Roux 17 cm / 6 6/8"	
2008	HMI-SI-2222	Retractors Farabeuf 12 cm / 4 6/8"	
			



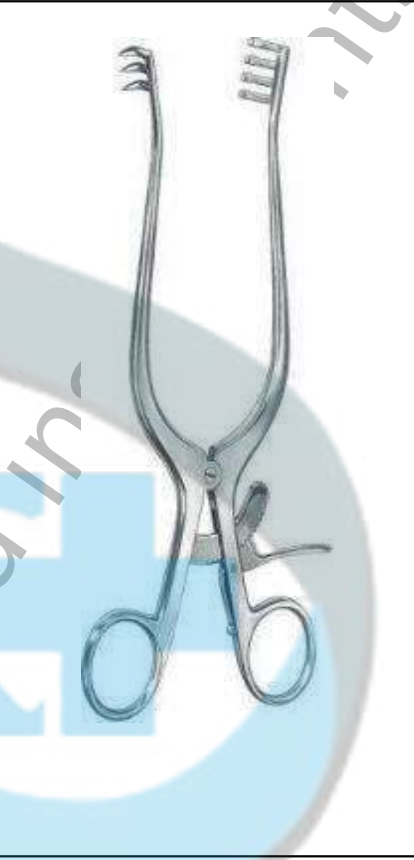
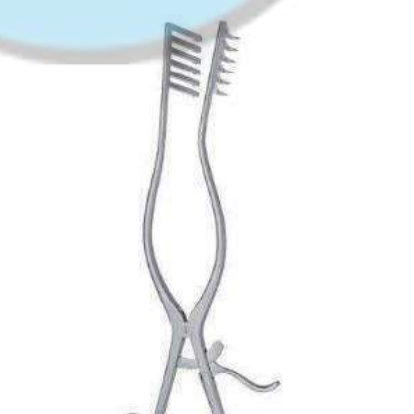

2009	HMI-SI-2223	Retractors Farabeuf 15,5 cm / 6 1/8"	
2010	HMI-SI-2224	Retractors Roux-Mini 14,5 cm / 5 6/8"	
2011	HMI-SI-2225	Retractors Roux-Baby 12,5 cm / 4 7/8"	
2012	HMI-SI-2226	Retractors Parker 14 cm / 5 4/8"	
2013	HMI-SI-2227	Retractors Parker 18,5 cm / 7 2/8"	
2014	HMI-SI-2228	Retractors Parker-Mott 16 cm / 6 2/8"	
2015	HMI-SI-2229	Retractors Mathieu 20 cm / 7 7/8"	
2016	HMI-SI-2230	Retractors Parker-Langenbeck 21,5 cm / 8 4/8"	





2017	HMI-SI-2231	Retractors Goelet 19 cm / 7 4/8"	
2018	HMI-SI-2232	Wound Spreaders, self-retaining Finsen sharp 5 cm / 2 "	
2019	HMI-SI-2233	Wound Spreaders, self-retaining Finsen blunt 5 cm / 2 "	
2020	HMI-SI-2234	Wound Spreaders, self-retaining Finsen sharp 7 cm / 2 6/8"	
2021	HMI-SI-2235	Wound Spreaders, self-retaining Finsen blunt 7 cm / 2 6/8"	
2022	HMI-SI-2236	Wound Spreaders, self-retaining Finsen-Martin 7,5 cm / 3 " with adjusting screw, sharp	
2023	HMI-SI-2237	Wound Spreaders, self-retaining Finsen-Martin 7,5 cm / 3 " with adjusting screw, blunt	
2024	HMI-SI-2238	Wound Spreaders, self-retaining Buckley 6 cm / 2 3/8" Sharp	
2025	HMI-SI-2239	Wound Spreaders, self-retaining Logan 4 cm / 1 3/8"	
2026	HMI-SI-2239(a)	Wound Spreaders, self-retaining Logan with adjusting screw, sharp 4 cm / 1 3/8"	





2027	HMI-SI-2240	Wound Spreaders, self-retaining Blunt 10 cm / 3 7/8"	
2028	HMI-SI-2241	Wound Spreaders, self-retaining Alm with adjusting screw 7 cm / 2 6/8" Sharp	
2029	HMI-SI-2242	Wound Spreaders, self-retaining Alm with adjusting screw 10 cm / 3 7/8" Sharp	
2030	HMI-SI-2243	Wound Spreaders, self-retaining Alm with adjusting screw 7 cm / 2 6/8" Blunt	
2031	HMI-SI-2244	Wound Spreaders, self-retaining Alm with adjusting screw 10 cm / 3 7/8" Blunt	
2032	HMI-SI-2245	Wound Spreaders, self-retaining Jansen 10 cm / 3 7/8" with adjusting screw, blunt	
2033	HMI-SI-2246	Wound Spreaders, self-retaining Jansen 10 cm / 3 7/8" with adjusting screw, Sharp	
2034	HMI-SI-2247	Wound Spreaders, self-retaining Scalp-Contour 13,5 cm / 5 3/8" sharp	
2035	HMI-SI-2248	Wound Spreaders, self-retaining Scalp-Contour 13,5 cm / 5 3/8" blunt	
2036	HMI-SI-2249	Wound Spreaders, self-retaining Anderson-Adson 19 cm / 7 4/8" sharp	



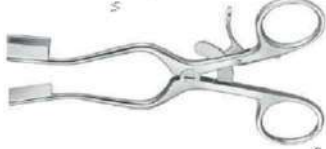

2037	HMI-SI-2250	Wound Spreaders, self-retaining Travers 21,5 cm / 8 4/8" blunt	
2038	HMI-SI-2251	Wound Spreaders, self-retaining Norfolk-Norwich 22 cm / 8 5/8" blunt	
2039	HMI-SI-2252	Wound Spreading Weitlaner sharp 20 cm / 7 7/8" 90 mm	
2040	HMI-SI-2253	Wound Spreaders, self-retaining Weitlaner sharp 24 cm / 9 4/8" 90 mm	
2041	HMI-SI-2254	Wound Spreaders, self-retaining Weitlaner sharp 25,5 cm / 10" 90 mm	
2042	HMI-SI-2255	Wound Spreaders, self-retaining Weitlaner semi-sharp 20 cm / 7 7/8" 90 mm	
2043	HMI-SI-2256	Wound Spreaders, self-retaining Weitlaner semi-sharp 24 cm / 9 4/8" 90 mm	
2044	HMI-SI-2257	Wound Spreaders, self-retaining Weitlaner blunt 20 cm / 7 7/8" 90 mm	
2045	HMI-SI-2258	Wound Spreaders, self-retaining Weitlaner blunt 24 cm / 9 4/8" 90 mm	
2046	HMI-SI-2259	Wound Spreaders, self-retaining Weitlaner blunt 25,5 cm / 10" 90 mm	
2047	HMI-SI-2260	Wound Spreaders, self-retaining Adson 26 cm / 10 2/8" sharp	
2048	HMI-SI-2261	Wound Spreaders, self-retaining Adson 26 cm / 10 2/8" semi-sharp	
2049	HMI-SI-2262	Wound Spreaders, self-retaining Adson 26 cm / 10 2/8" blunt	
2050	HMI-SI-2263	Wound Spreaders, self-retaining Adson 29 cm / 11 3/8" sharp	





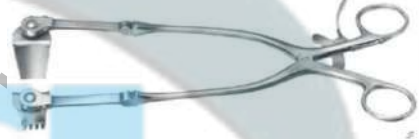



2051	HMI-SI-2264	Wound Spreaders, self-retaining Adson 29 cm / 11 3/8" blunt	
2052	HMI-SI-2266	Wound Spreaders, self-retaining sharp 25,5 cm / 10"	
2053	HMI-SI-2267	Wound Spreaders, self-retaining semi-sharp 25,5 cm / 10"	
2054	HMI-SI-2268	Wound Spreaders, self-retaining blunt 25,5 cm / 10"	
2055	HMI-SI-2270	Wound Spreaders, self-retaining sharp 13 cm / 5 1/8"	
2056	HMI-SI-2271	Wound Spreaders, self-retaining blunt 13 cm / 5 1/8"	
2057	HMI-SI-2272	Wound Spreaders, self-retaining Weitlaner sharp 11 cm / 4 3/8"	
2058	HMI-SI-2273	Wound Spreaders, self-retaining Weitlaner semi-sharp 11 cm / 4 3/8"	







2059	HMI-SI-2274	Wound Spreaders, self-retaining Weitlaner blunt 11 cm / 4 3/8"	
2060	HMI-SI-2275	Wound Spreaders, self-retaining Weitlaner sharp 13,5 cm / 5 3/8"	
2061	HMI-SI-2276	Wound Spreaders, self-retaining Weitlaner sharp 16 cm / 6 2/8"	
2062	HMI-SI-2277	Wound Spreaders, self-retaining Weitlaner semi-sharp 13,5 cm / 5 3/8"	
2063	HMI-SI-2278	Wound Spreaders, self-retaining Weitlaner semi-sharp 16 cm / 6 2/8"	
2064	HMI-SI-2279	Wound Spreaders, self-retaining Weitlaner blunt 13,5 cm / 5 3/8"	
2065	HMI-SI-2280	Wound Spreaders, self-retaining Weitlaner blunt 16 cm / 6 2/8"	
2066	HMI-SI-2281	Wound Spreaders, self-retaining Weitlaner-Wullstein 13 cm / 5 1/8" sharp	
2067	HMI-SI-2282	Wound Spreaders, self-retaining Weitlaner-Wullstein 13 cm / 5 1/8" blunt	
2068	HMI-SI-2283	Wound Spreaders, self-retaining Mollison 15,5 cm / 6 1/8" sharp	
2069	HMI-SI-2284	Wound Spreaders, self-retaining Plester 13 cm / 5 1/8" blunt	





2070	HMI-SI-2285	Wound Spreaders, self-retaining Plester 13 cm / 5 1/8" sharp	
2071	HMI-SI-2286	Wound Spreaders, self-retaining Plester 10,5 cm / 4 1/8" blunt	
2072	HMI-SI-2287	Wound Spreaders, self-retaining Plester 10,5 cm / 4 1/8" blunt	
2073	HMI-SI-2288	Wound Spreaders, self-retaining Blade left full 50 x 10 mm	
2074	HMI-SI-2289	Wound Spreaders, self-retaining Blade rightfull 50 x 10 mm	
2075	HMI-SI-2290	Wound Spreaders, self-retaining Blade left full 60 x 10 mm	
2076	HMI-SI-2291	Wound Spreaders, self-retaining Blade rightfull 60 x 10 mm	
2077	HMI-SI-2292	Wound Spreaders, self-retaining Blade left full 70 x 10 mm	
2078	HMI-SI-2293	Wound Spreaders, self-retaining Blade rightfull 70 x 10 mm	
2079	HMI-SI-2294	Wound Spreaders, self-retaining Milligan 13,5 cm / 5 3/8" blunt	
2080	HMI-SI-2295	Wound Spreaders, self-retaining Weitlaner-Baby 13,5 cm / 5 3/8"	







2081	HMI-SI-2296	Wound Spreaders, self-retaining Hartmann without central blad 26 cm / 10 2/8" blunt	
2082	HMI-SI-2297	Wound Spreaders, self-retaining without central blad 30 x 15 mm	
2083	HMI-SI-2298	Wound Spreaders, self-retaining, Central Blades Henley blunt 16,5 cm / 6 4/8"	
2084	HMI-SI-2299	Wound Spreaders, self-retaining, Central Blades Henley sharp 16,5 cm / 6 4/8"	
2085	HMI-SI-2300	Wound Spreaders, self-retaining, Central Blades 19 x 17 mm	
2086	HMI-SI-2301	Wound Spreaders, self-retaining, Central Blades 25 x 17 mm	
2087	HMI-SI-2302	Wound Spreaders, self-retaining, Central Blades 32 x 17 mm	
2088	HMI-SI-2303	Wound Spreaders, self-retaining Adson Sharp 14 cm / 5 4/8" 81 mm	
2089	HMI-SI-2304	Wound Spreaders, self-retaining Adson Sharp 16,5 cm / 6 4/8" 90 mm	
2090	HMI-SI-2305	Wound Spreaders, self-retaining Adson Sharp 21 cm / 8 2/8" 135 mm	
2091	HMI-SI-2306	Wound Spreaders, self-retaining Adson Sharp 24,5 cm / 9 5/8" 135 mm	
2092	HMI-SI-2307	Wound Spreaders, self-retaining Adson Blunt 14 cm / 5 4/8" 81 mm	
2093	HMI-SI-2308	Wound Spreaders, self-retaining Adson Blunt 16,5 cm / 6 4/8" 90 mm	
2094	HMI-SI-2309	Wound Spreaders, self-retaining Adson Blunt 21 cm / 8 2/8" 135 mm	

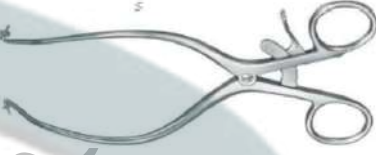

2095	HMI-SI-2310	Wound Spreaders, self-retaining Adson Blunt 24,5 cm / 9 5/8" 135 mm	
2096	HMI-SI-2311	Wound Spreaders, self-retaining Adson Semi-sharp 14 cm / 5 4/8" 81 mm	
2097	HMI-SI-2312	Wound Spreaders, self-retaining Adson Semi-sharp 16,5 cm / 6 4/8" 90 mm	
2098	HMI-SI-2313	Wound Spreaders, self-retaining Adson Semi-sharp 21 cm / 8 2/8" 135 mm	
2099	HMI-SI-2314	Wound Spreaders, self-retaining Adson Semi-sharp 24,5 cm / 9 5/8" 135 mm	
2100	HMI-SI-2315	Wound Spreaders, self-retaining Adson blunt 14 cm / 5 4/8"	
2101	HMI-SI-2316	Wound Spreaders, self-retaining Cloward 149 mm	
2102	HMI-SI-2317	Wound Spreaders, self-retaining Cloward toothed, pair 4 cm / 1 5/8"	
2103	HMI-SI-2318	Wound Spreaders, self-retaining Cloward toothed, pair 4,5 cm / 1 6/8"	
2104	HMI-SI-2319	Wound Spreaders, self-retaining Cloward toothed, pair 5 cm / 2"	

2105	HMI-SI-2320	Wound Spreaders, self-retaining Cloward toothed, pair 5,5 cm / 2 1/8"	
2106	HMI-SI-2321	Wound Spreaders, self-retaining Cloward toothed, pair 6 cm / 2 3/8"	
2107	HMI-SI-2322	Wound Spreaders, self-retaining Cloward with 2 each plug-in blades	
2108	HMI-SI-2323	Wound Spreaders, self-retaining Cloward smooth, pair 4 cm / 1 5/8"	
2109	HMI-SI-2324	Wound Spreaders, self-retaining Cloward smooth, pair 4,5 cm / 1 6/8"	
2110	HMI-SI-2325	Wound Spreaders, self-retaining Cloward smooth, pair 5 cm / 2"	
2111	HMI-SI-2326	Wound Spreaders, self-retaining Cloward smooth, pair 5,5 cm / 2 1/8"	
2112	HMI-SI-2327	Wound Spreaders, self-retaining Cloward smooth, pair 6 cm / 2 3/8"	







2113	HMI-SI-2329	Wound Spreaders, self-retaining Beckmann sharp 32 cm / 12 5/8"	
2114	HMI-SI-2330	Wound Spreaders, self-retaining Beckmann sharp 31,5 cm / 12 3/8"	
2115	HMI-SI-2331	Wound Spreaders, self-retaining Adson sharp 33 cm / 13 "	
2116	HMI-SI-2332	Wound Spreaders, self-retaining Adson semi-sharp 33 cm / 13 "	
2117	HMI-SI-2333	Wound Spreaders, self-retaining Beckman-Adson 142 mm 31 cm / 12 2/8" blunt	
2118	HMI-SI-2334	Wound Spreaders, self-retaining Beckman-Adson 142 mm 31 cm / 12 2/8" sharp	
2119	HMI-SI-2335	Wound Spreaders, self-retaining Beckman-Adson 142 mm 30,5 cm / 12 " blunt	
2120	HMI-SI-2336	Wound Spreaders, self-retaining Beckman-Adson 142 mm 30,5 cm / 12 " sharp	
2121	HMI-SI-2337	Wound Spreaders, self-retaining Beckman-Eaton 32 cm / 12 5/8" sharp	
2122	HMI-SI-2338	Wound Spreaders, self-retaining Martin 28,5 cm / 11 2/8" sharp, long teeth on left side	





2123	HMI-SI-2339	Wound Spreaders, self-retaining Martin 28,5 cm / 11 2/8" sharp, long teeth on right side	
2124	HMI-SI-2340	Wound Spreaders, self-retaining Vickers Low-Proyle 6 cm / 2 3/8" blunt	
2125	HMI-SI-2341	Wound Spreaders, self-retaining Vickers Low-Proyle 9 cm / 3 4/8" blunt	
2126	HMI-SI-2342	Wound Spreaders, self-retaining Vickers Low-Proyle 7,5 cm / 3 " blunt	
2127	HMI-SI-2343	Wound Spreaders, self-retaining spring	
2128	HMI-SI-2344	Wound Spreaders, self-retaining Mittelvalven 10 x 18 mm	
2129	HMI-SI-2345	Wound Spreaders, self-retaining Mittelvalven 10 x 12 mm	
2130	HMI-SI-2346	Wound Spreaders, self-retaining Vickers 5 cm / 3 "	

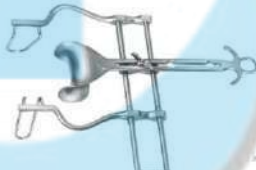



2131	HMI-SI-2347	Wound Spreaders, self-retaining Joll 15,5 cm / 6 1/8"	
2132	HMI-SI-2348	Wound Spreaders, self-retaining Gelpi 13 cm / 5 1/8"	
2133	HMI-SI-2349	Wound Spreaders, self-retaining Gelpi 18 cm / 7 1/8"	
2134	HMI-SI-2350	Wound Spreaders, self-retaining Gelpi 18,5 cm / 7 2/8"	
2135	HMI-SI-2351	Abdominal Retractors Collin, Baby 18 cm / 7 1/8"	
2136	HMI-SI-2352	Abdominal Retractors Collin 20 cm / 7 7/8"	
2137	HMI-SI-2353	Abdominal Retractors Collin 20 cm / 7 7/8" complete, with 1 pair of lateral blades	
2138	HMI-SI-2354	Abdominal Retractors Collin 20 cm / 7 7/8" complete, with 1 pair of lateral blades	



2139	HMI-SI-2355	Abdominal Retractors Collin central blad	
2140	HMI-SI-2356	Abdominal Retractors Collin central blad	
2141	HMI-SI-2357	Abdominal Retractors Collin 31 cm / 12 2/8" complete, with 1 pair of lateral blades	
2142	HMI-SI-2358	Abdominal Retractors Collin central blad	
2143	HMI-SI-2359	Abdominal Retractors Ricard complete with 1 pair of lateral blades 220 mm	
2144	HMI-SI-2360	Abdominal Retractors Ricard complete with 1 pair of lateral blades 250 mm	
2145	HMI-SI-2361	Abdominal Retractors Ricard Central Blade 55 x 70 mm	
2146	HMI-SI-2361(a)	Abdominal Retractors Ricard Central Blade 80 x 90 mm	







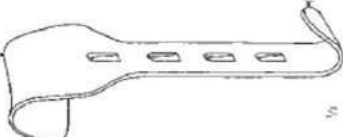
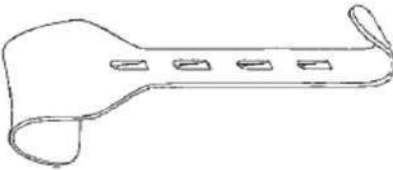
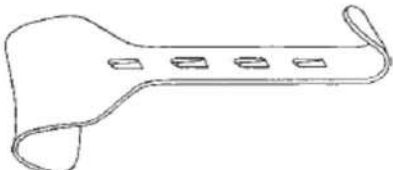
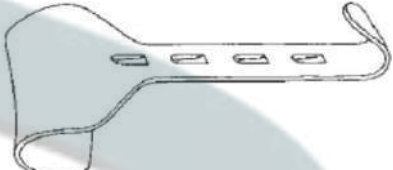
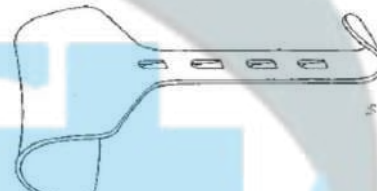
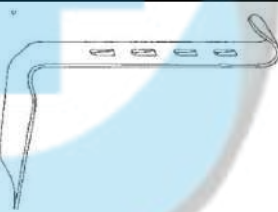
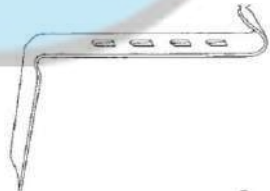

2147	HMI-SI-2362	Abdominal Retractors Ricard Spreader, only	
2148	HMI-SI-2363	Abdominal Retractors Ricard Spreader, only piece	
2149	HMI-SI-2364	Abdominal Retractors Ricard Spreader, only piece	
2150	HMI-SI-2365	Lateral Blades for abdominal retractors 18 x 40 mm	
2151	HMI-SI-2366	Lateral Blades for abdominal retractors 27 x 40 mm	
2152	HMI-SI-2367	Lateral Blades for abdominal retractors 38 x 60 mm	
2153	HMI-SI-2368	Lateral Blades for abdominal retractors 45 x 80 mm	
2154	HMI-SI-2369	Lateral Blades for abdominal retractors 60 x 80 mm	
2155	HMI-SI-2371	Lateral Blades for abdominal retractors 50 x 70 mm	
2156	HMI-SI-2372	Lateral Blades for abdominal retractors 50 x 58 mm	
2157	HMI-SI-2373	Lateral Blades for abdominal retractors 52 x 110 mm	
2158	HMI-SI-2374	Lateral Blades for abdominal retractors 60 x 80 mm	
2159	HMI-SI-2375	Lateral Blades for abdominal retractors 70 x 55 mm	
2160	HMI-SI-2376	Lateral Blades for abdominal retractors 72 x 85 mm	
2161	HMI-SI-2377	Lateral Blades Gosset lateral blades 63 x 35 mm, 1 central blade 60 x 65 mm	









2162	HMI-SI-2377(a)	Lateral Blades Gosset central blad 60 x 65 mm	
2163	HMI-SI-2378	Lateral Blades Gosset-Baby 12,5 cm / 4 7/8" 120 mm	
2164	HMI-SI-2379	Lateral Blades Gosset 18,5 cm / 7 2/8" 140 mm	
2165	HMI-SI-2380	Lateral Blades Gosset central blade 12,5 cm / 4 7/8" 24 x 20 mm	
2166	HMI-SI-2381	Lateral Blades Balfour-Baby 12,5 cm / 4 7/8" complete, with 1 pair of lateral blades (30 x 20 mm) and central blade ref. 15-850-92-99 (24 x 20 mm)	
2167	HMI-SI-2382	Abdominal Retractors Balfour 20 cm / 7 7/8" complete, with 1 pair of lateral blades (70 x 35 mm) and central blade ref. 15-859-01-07 (45 x 80 mm)	
2168	HMI-SI-2383	Abdominal Retractors Balfour 20 cm / 7 7/8" complete, with 1 pair of lateral blades (70 x 35 mm) and central blade ref. 15-859-01-07 (45 x 80 mm)	
2169	HMI-SI-2384	Abdominal Retractors Balfour 20 cm / 7 7/8" complete, with 1 pair of lateral blades (100 x 35 mm) and central blade ref. 15-856-91- 98 (100 x 60 mm)	







2170	HMI-SI-2385	Abdominal Retractors Balfour central blade 100 x 70 mm	
2171	HMI-SI-2386	Abdominal Retractors Balfour central blade 100 x 60 mm	
2172	HMI-SI-2387	Abdominal Retractors Balfour-Standard 20 cm / 7 7/8" complete, with 1 pair of lateral blades (100 x 35 mm) and central blade ref. 15-859-02-07 (68 x 85 mm)	
2173	HMI-SI-2388	Abdominal Retractors Balfour 45 x 80 mm	
2174	HMI-SI-2389	Abdominal Retractors Balfour 68 x 85 mm	
2175	HMI-SI-2390	Abdominal Retractors Balfour 40 x 68 mm	
2176	HMI-SI-2391	Abdominal Retractors Balfour, Mod. USA 20 cm / 7 7/8" 190 mm	
2177	HMI-SI-2392	Abdominal Retractors Balfour, Mod. USA Fenestrated Blades (pair) 60 x 30 mm	



2178	HMI-SI-2393	Abdominal Retractors Balfour, Mod. USA Fenestrated Blades (pair) 80 x 30 mm	
2179	HMI-SI-2394	Abdominal Retractors O'Sullivan-O'Connor 20 cm / 7 7/8" 190 mm	
2180	HMI-SI-2395	Abdominal Retractors O'Sullivan-O'Connor central blad 80 x 45 mm	
2181	HMI-SI-2396	Abdominal Retractors O'Sullivan-O'Connor central blad 110 x 70 mm	
2182	HMI-SI-2397	Abdominal Retractors Kirschner Frame ref. 15-882-30-07, 3 retractors ref. 15-889-50-07 and 1 retractor each ref. 15-889-80-07, 15-889-98-07 and 15-889-99-07	
2183	HMI-SI-2398	Abdominal Retractors Kirschner Frame, only 300 x 240 mm	
2184	HMI-SI-2399	Abdominal Retractors Kirschner frame ref. 15-884-24-07, 2 hooks ref. 15-889-40-07 and 2 hooks ref. 15-889-50-07	
2185	HMI-SI-2400	Abdominal Retractors Kirschner Frame, only 240 x 240 mm	





2186	HMI-SI-2401	Blades 40 x 55 mm Standard	
2187	HMI-SI-2402	Blades 50 x 65 mm Standard	
2188	HMI-SI-2403	Blades 60 x 85 mm Standard	
2189	HMI-SI-2404	Blades 78 x 65 mm	
2190	HMI-SI-2405	Blades 85 x 90 mm	
2191	HMI-SI-2406	Blades 98 x 50 mm	
2192	HMI-SI-2407	Blades 105 x 35 mm	
2193	HMI-SI-2408	Laminectomy Retractors Scoville 22 cm / 8 5/8" 190 mm	





2194	HMI-SI-2409	Laminectomy Retractors Scoville-Haverlyeld 22 cm / 8 5/8" frame only, with joint 190 mm	
2195	HMI-SI-2410	Blades 5 cm / 2 " Hook, piece 50 mm deep, blunt	
2196	HMI-SI-2411	Blades 7 cm / 2 6/8" Hook, piece 70 mm deep, blunt	
2197	HMI-SI-2412	Blades 5 cm / 2 " Hook, piece 50 mm deep, sharp	
2198	HMI-SI-2413	Blades 7 cm / 2 6/8" Hook, piece 70 mm deep, blunt	
2199	HMI-SI-2414	Blades, piece toothed 60 x 25 mm	
2200	HMI-SI-2415	Blades, piece toothed 61 x 50 mm	
2201	HMI-SI-2416	Blades, piece toothed 86 x 25 mm	
2202	HMI-SI-2417	Hook, piece sharp 48 x 50 mm	
2203	HMI-SI-2418	Hook, piece sharp 64 x 50 mm	
2204	HMI-SI-2419	Hook, piece sharp 64 x 64 mm	
2205	HMI-SI-2420	Hook, piece sharp 80 x 57 mm	
2206	HMI-SI-2421	Hook, piece sharp 44 x 38 mm	









2207	HMI-SI-2422	Hook, piece sharp 67 x 44 mm	
2208	HMI-SI-2423	Martin Arm System	
2209	HMI-SI-2424	Martin Arm System Optics mounting	
2210	HMI-SI-2425	Universal Fixation Clamp for Martin Arm system	
2211	HMI-SI-2426	Retractor System Martin-Rochard	
2212	HMI-SI-2427	Retractor System Universal Fixation Clamp	
2213	HMI-SI-2428	Retractor System Fixation Arm, lateral	
2214	HMI-SI-2429	Retractor System Cross Bar, hexagon	

2215	HMI-SI-2430	Retractor System Sliding Clamp	
2216	HMI-SI-2431	Retractor System Fixing device for hooks	
2217	HMI-SI-2432	Retractor System Retractor, 50 x 105 mm	
2218	HMI-SI-2433	Retractor System Retractor, 50 x 120 mm	
2219	HMI-SI-2434	Retractor System Retractor, 50 x 160 mm	
2220	HMI-SI-2435	Abdominal Spatulas malleable 33 cm / 13 " 30 mm	
2221	HMI-SI-2436	Abdominal Spatulas malleable 33 cm / 13 " 40 mm	
2222	HMI-SI-2437	Abdominal Spatulas malleable 33 cm / 13 " 50 mm	





2223	HMI-SI-2438	Abdominal Spatulas Haberer tapered 20 cm / 7 7/8" 16 mm - 25 mm	
2224	HMI-SI-2439	Abdominal Spatulas Haberer tapered 28 cm / 11 " 25 mm - 30 mm	
2225	HMI-SI-2440	Abdominal Spatulas Haberer tapered 30 cm / 11 6/8" 37 mm - 45 mm	
2226	HMI-SI-2441	Abdominal Spatulas Martin malleable, very soft 20 cm / 7 7/8" 6,5 mm	
2227	HMI-SI-2442	Abdominal Spatulas Martin malleable, very soft 20 cm / 7 7/8" 9,5 mm	
2228	HMI-SI-2443	Abdominal Spatulas Martin malleable, very soft 20 cm / 7 7/8" 13 mm	
2229	HMI-SI-2444	Abdominal Spatulas Martin malleable, very soft 20 cm / 7 7/8" 16 mm	
2230	HMI-SI-2445	Abdominal Spatulas Martin malleable, very soft 20 cm / 7 7/8" 19 mm	
2231	HMI-SI-2446	Abdominal Spatulas Martin malleable, very soft 20 cm / 7 7/8" 25 mm	
2232	HMI-SI-2447	Probes 11 cm / 4 3/ 8" Ø 2,0 mm	
2233	HMI-SI-2448	Probes 13 cm / 5 1/ 8" Ø 2,0 mm	
2234	HMI-SI-2449	Probes 14,5 cm / 5 6/ 8" Ø 2,0 mm	
2235	HMI-SI-2450	Probes 16 cm / 6 2/ 8" Ø 2,0 mm	
2236	HMI-SI-2451	Probes 18 cm / 7 1/ 8" Ø 2,0 mm	
2237	HMI-SI-2452	Probes 20 cm / 7 7/ 8" Ø 2,0 mm	
2238	HMI-SI-2453	Probes 25 cm / 9 7/ 8" Ø 2,0 mm	

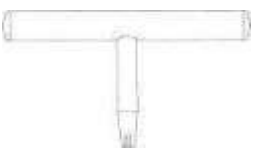

2239	HMI-SI-2454	Probes 30 cm / 11 76/ 8" Ø 2,0 mm	
2240	HMI-SI-2455	Probes 11,5 cm / 4 4/ 8" Ø 1,0 mm	
2241	HMI-SI-2456	Probes 13 cm / 5 1/ 8" Ø 1,0 mm	
2242	HMI-SI-2457	Probes 14,5 cm / 5 4/ 8" Ø 1,0 mm	
2243	HMI-SI-2458	Probes 16 cm / 6 2/ 8" Ø 1,0 mm	
2244	HMI-SI-2459	Probes 18 cm / 7 1/ 8" Ø 1,0 mm	
2245	HMI-SI-2460	Probes 20 cm / 7 7/ 8" Ø 1,0 mm	
2246	HMI-SI-2461	Probes 13 cm / 5 1/ 8" Ø 1,5 mm	
2247	HMI-SI-2462	Probes 14,5 cm / 5 6/ 8" Ø 1,5 mm	
2248	HMI-SI-2463	Probes 16 cm / 6 2/ 8" Ø 1,5 mm	
2249	HMI-SI-2464	Probes 18 cm / 7 7/ 8" Ø 1,5 mm	
2250	HMI-SI-2465	Probes 20 cm / 7 7/ 8" Ø 1,5 mm	
2251	HMI-SI-2466	Probes 25 cm / 9 7/ 8" Ø 1,5 mm	
2252	HMI-SI-2467	Probes with eye 13 cm / 5 1/ 8" Ø 2,0 mm	
2253	HMI-SI-2468	Probes with eye 14,5 cm / 5 6/ 8" Ø 2,0 mm	
2254	HMI-SI-2469	Probes with eye 16 cm / 6 2/ 8" Ø 2,0 mm	
2255	HMI-SI-2470	Probes angled handle loop 10 cm / 3 7/ 8" Ø 1 mm	

2256	HMI-SI-2471	Probes Myrtle Leaf Probe 13 cm / 5 1/8" Ø 2,0 mm	
2257	HMI-SI-2472	Probes Myrtle Leaf Probe 14,5 cm / 5 6/8" Ø 2,0 mm	
2258	HMI-SI-2473	Probes Myrtle Leaf Probe 16 cm / 6 2/8" Ø 2,0 mm	
2259	HMI-SI-2474	Probes Myrtle Leaf Probe 18 cm / 7 1/8" Ø 2,0 mm	
2260	HMI-SI-2475	Probes Myrtle Leaf Probe 20 cm / 7 7/8" Ø 2,0 mm	
2261	HMI-SI-2476	Grooved Directors, Fistula Probes 13 cm / 5 1/8"	
2262	HMI-SI-2476(a)	Grooved Directors, Fistula Probes 14,5 cm / 5 6/8"	
2263	HMI-SI-2477	Grooved Directors, Fistula Probes 16 cm / 6 2/8"	
2264	HMI-SI-2478	Grooved Directors, Fistula Probes 13 cm / 5 1/8"	
2265	HMI-SI-2479	Grooved Directors, Fistula Probes 14,5 cm / 5 6/8"	
2266	HMI-SI-2480	Grooved Directors, Fistula Probes 16 cm / 6 2/8"	
2267	HMI-SI-2481	Grooved Directors, Fistula Probes Doyen 14,5 cm / 5 6/8"	

2268	HMI-SI-2481(a)	Grooved Directors, Fistula Probes Nelaton 16 cm / 6 2 /8"	
2269	HMI-SI-2482	Grooved Directors, Fistula Probes Lockhart-Mummery 16,5 cm / 6 4/8"	
2270	HMI-SI-2483	Grooved Directors, Fistula Probes Lockhart-Mummery 16,5 cm / 6 4/8"	
2271	HMI-SI-2484	Grooved Directors, Fistula Probes Lockhart-Mummery 16,5 cm / 6 4/8"	
2272	HMI-SI-2485	Grooved Directors, Fistula Probes Lockhart-Mummery 16,5 cm / 6 4/8"	
2273	HMI-SI-2486	Varix Instruments Varady Varicose Vein Probe Set	
2274	HMI-SI-2486(a)	Varix Instruments Varady set including Olive Ø 3,0 mm	
2275	HMI-SI-2487	Varix Instruments Varady set including Olive Ø 4,0 mm	
2276	HMI-SI-2488	Varix Instruments Varady set including Olive Ø 5,0 mm	
2277	HMI-SI-2489	Varix Instruments Varady set including Traction Cable 45 mm	
2278	HMI-SI-2490	Varix Instruments Varady Phlebotomiser 18 cm / 7 1/8" Ø 0,3 mm	





2279	HMI-SI-2491	Varix Instruments Varady Phlebextractor 18 cm / 7 1/8" Ø 0,75 mm	
2280	HMI-SI-2492	Varix Instruments Varady Phlebextractor 18 cm / 7 1/8" Ø 0,75 mm	
2281	HMI-SI-2493	Varix Instruments Varady Micro Dissector 17 cm / 6 6/8" Ø 0,25 mm	
2282	HMI-SI-2494	Varix Instruments Varady Micro Phlebextractor 17 cm / 6 6/8" Ø 0,35 mm	
2283	HMI-SI-2495	Varix Instruments Varady Mini Phlebextractor 17 cm / 6 6/8" Ø 0,35 mm	
2284	HMI-SI-2496	Varix Instruments Nabato, Varicose Vein Probe Set	
2285	HMI-SI-2497	Varix Instruments Nabato, Varicose Vein Probe set including Plastic Probe Tip	
2286	HMI-SI-2498	Varix Instruments Nabato, Varicose Vein Probe set Olive Ø 3,0 mm	
2287	HMI-SI-2499	Varix Instruments Nabato, Varicose Vein Probe set Olive Ø 6,0 mm	
2288	HMI-SI-2500	Varix Instruments Nabato, Varicose Vein Probe set Olive Ø 9,0 mm	





2289	HMI-SI-2501	Varix Instruments Nabato, Varicose Vein Probe set Olive Ø 12,0 mm	
2290	HMI-SI-2502	Varix Instruments Nabato, Varicose Vein Probe set Handle, T-form	
2291	HMI-SI-2503	Varix Instruments Nabato, Varicose Vein Probe set Traction Cable 90 mm	
2292	HMI-SI-2504	Varix Instruments Nabato, Varicose Vein Probe set Not included in the set Olive Ø 15,0 mm	
2293	HMI-SI-2505	Ringstripper Vollmar blunt 50 cm / 19 5/8" Ø 2,0 mm	
2294	HMI-SI-2506	Ringstripper Vollmar blunt 50 cm / 19 5/8" Ø 3,0 mm	
2295	HMI-SI-2507	Ringstripper Vollmar blunt 50 cm / 19 5/8" Ø 4,0 mm	
2296	HMI-SI-2508	Ringstripper Vollmar blunt 50 cm / 19 5/8" Ø 6,0 mm	
2297	HMI-SI-2509	Ringstripper Vollmar blunt 50 cm / 19 5/8" Ø 7,0 mm	
2298	HMI-SI-2510	Ringstripper Vollmar blunt 50 cm / 19 5/8" Ø 8,0 mm	
2299	HMI-SI-2511	Ringstripper Vollmar blunt 50 cm / 19 5/8" Ø 10,0 mm	
2300	HMI-SI-2512	Ringstripper Vollmar blunt 50 cm / 19 5/8" Ø 12,0 mm	
2301	HMI-SI-2513	Ringstripper Vollmar blunt 50 cm / 19 5/8" Ø 14,0 mm	
2302	HMI-SI-2514	Ringstripper Handle for Vollmar Ring Stripper 11,5 cm / 4 4/8"	





2303	HMI-SI-2515	Cotton Applicators Farrell 12 cm / 4 6/8" Ø 0,9 mm	
2304	HMI-SI-2516	Cotton Applicators Farrell 14 cm / 5 4/8" Ø 0,9 m	
2305	HMI-SI-2517	Cotton Applicators Farrell 16 cm / 6 2/8" Ø 0,9 mm	
2306	HMI-SI-2518	Cotton Applicators Farrell triangular 14 cm / 5 4/8" Ø 1,2 mm	
2307	HMI-SI-2519	Cotton Applicators Farrell triangular 16 cm / 6 2/8" Ø 1,2 mm	
2308	HMI-SI-2520	Cotton Applicators Farrell triangular 18 cm / 7 1/8" Ø 1,2 mm	
2309	HMI-SI-2521	Trocars Universal with 4 trocar tips 14 cm / 5 4/8" Ø 1,7 / 3,0 / 4,5 / 6,0 mm	
2310	HMI-SI-2522	Trocars Nelson 21 cm / 8 2/8" Ø 7,5 mm	







2311	HMI-SI-2523	Trocars Nelson 21 cm / 8 2/8" Ø 9,5 mm
2312	HMI-SI-2524	Trocars Nelson 21 cm / 8 2/8" Ø 11 mm
2313	HMI-SI-2525	Suction Cannulas pediatric suction tubes, with perforated screw tip 18 cm / 7 1/8" 45° Ø 3,3 mm
2314	HMI-SI-2526	Suction Cannulas pediatric suction tubes, with perforated screw tip 18 cm / 7 1/8" 45° Ø 5 mm
2315	HMI-SI-2527	Suction Cannulas pediatric suction tubes, with perforated screw tip 16 cm / 6 2/8" 90° Ø 3,3 mm
2316	HMI-SI-2528	Suction Cannulas pediatric suction tubes, with perforated screw tip 16 cm / 6 2/8" 90° Ø 5 mm
2317	HMI-SI-2529	Suction Cannulas pediatric suction tubes 21 cm / 8 2/8" 45° Ø 3,3 mm
2318	HMI-SI-2530	Suction Cannulas pediatric suction tubes 21 cm / 8 2/8" 45° Ø 5 mm
2319	HMI-SI-2531	Suction Cannulas pediatric suction tubes 18 cm / 7 1/8" 60° Ø 3,3 mm
2320	HMI-SI-2532	Suction Cannulas pediatric suction tubes 18 cm / 7 1/8" 60° Ø 5 mm

















2321	HMI-SI-2533	Suction Cannulas pediatric suction tubes 15 cm / 5 7/8" 90° Ø 3,3 mm	
2322	HMI-SI-2534	Suction Cannulas pediatric suction tubes 15 cm / 5 7/8" 90° Ø 5 mm	
2323	HMI-SI-2535	Suction Tubes MIS Suction cannulas with suction stop 39 cm / 15 2/8" Ø 6 mm	
2324	HMI-SI-2536	Suction Tubes Adson 20 cm / 7 7/8" Ø 4 mm	
2325	HMI-SI-2537	Suction Tubes Frazier 24 cm / 9 4/8" Ø 3,3 mm	
2326	HMI-SI-2538	Suction Tubes Frazier 19,5 cm / 7 5/8" working length 130 mm Ø 2,0 mm	
2327	HMI-SI-2539	Suction Tubes Frazier 19,5 cm / 7 5/8" working length 130 mm Ø 2,3 mm	
2328	HMI-SI-2540	Suction Tubes Frazier 19,5 cm / 7 5/8" working length 130 mm Ø 2,7 mm	
2329	HMI-SI-2541	Suction Tubes Frazier 19,5 cm / 7 5/8" working length 130 mm Ø 3,0 mm	
2330	HMI-SI-2542	Suction Tubes Frazier 19,5 cm / 7 5/8" working length 130 mm Ø 3,3 mm	
2331	HMI-SI-2543	Suction Tubes Frazier 19,5 cm / 7 5/8" working length 130 mm Ø 3,6 mm	
2332	HMI-SI-2544	Suction Tubes Frazier 19,5 cm / 7 5/8" working length 130 mm Ø 4,0 mm	
2333	HMI-SI-2545	Suction Tubes Frazier 19,5 cm / 7 5/8" working length 130 mm Ø 5,0 mm	









2334	HMI-SI-2546	Suction Tubes Fergusson working length 110 mm Ø 1,5 mm	
2335	HMI-SI-2547	Suction Tubes Fergusson working length 110 mm Ø 2 mm	
2336	HMI-SI-2548	Suction Tubes Fergusson working length 110 mm Ø 2,5 mm	
2337	HMI-SI-2549	Suction Tubes Fergusson working length 110 mm Ø 3 mm	
2338	HMI-SI-2550	Suction Tubes Fergusson working length 110 mm Ø 4 mm	
2339	HMI-SI-2551	Suction Tubes Fergusson working length 110 mm Ø 5 mm	
2340	HMI-SI-2552	Suction Cannulas Poppen working length 90 mm Ø 2,0 mm	
2341	HMI-SI-2553	Suction Cannulas Poppen working length 90 mm Ø 2,6 mm	
2342	HMI-SI-2554	Suction Cannulas Poppen working length 90 mm Ø 3,3 mm	
2343	HMI-SI-2555	Suction Cannulas Poppen working length 90 mm Ø 4,0 mm	
2344	HMI-SI-2556	Suction Cannulas Zoellner	
2345	HMI-SI-2557	Suction Tubes, Suction Tubes Wullstein 14 cm / 5 4/8" complete, with handle and 3 tips Ø 2,3 mm	
2346	HMI-SI-2558	Suction Tubes, Suction Tubes Micro suction cannula 4,5 cm / 1 6/8" Ø 0,4 mm	
2347	HMI-SI-2559	Suction Tubes, Suction Tubes Micro suction cannula 4,5 cm / 1 6/8" Ø 0,6 mm	





2348	HMI-SI-2560	Suction Tubes, Suction Tubes Micro suction cannula 4,5 cm / 1 6/8" Ø 0,8 mm	
2349	HMI-SI-2561	Suction Tubes, Suction Tubes Wullstein 14 cm / 5 4/8" Handle with tube, only Ø 2,5 mm	
2350	HMI-SI-2562	Suction Tubes, Suction Tubes Baron-Schuknecht with ynger cut- o, working length 75 mm Ø 1,0 mm	
2351	HMI-SI-2563	Suction Tubes, Suction Tubes Baron-Schuknecht with ynger cut- o, working length 75 mm Ø 1,5 mm	
2352	HMI-SI-2564	Suction Tubes, Suction Tubes Baron-Schuknecht with ynger cut- o, working length 75 mm Ø 2,0 mm	
2353	HMI-SI-2565	Suction Tubes Luer conical working length 110 mm 16,5 cm / 6 4/8" Ø 3,0 mm	
2354	HMI-SI-2566	Suction Tubes Luer conical working length 110 mm 16,5 cm / 6 4/8" Ø 4,5 mm	
2355	HMI-SI-2567	Suction Tubes Luer conical working length 130 mm 18 cm / 7 4/ 8" Ø 3,0 mm	
2356	HMI-SI-2567(a)	Suction Tubes Suction handle for tonsil cannula	











2357	HMI-SI-2568	Suction Tubes Landolt Suction tube for pituitary 25 cm / 9 7/8" Ø 3,2 mm	
2358	HMI-SI-2569	Suction Tubes Cerullo Suction valve	
2359	HMI-SI-2570	Suction Tubes Yasargil 17 cm / 6 6/8" working length 150 mm Ø 1,5 mm	
2360	HMI-SI-2571	Suction Tubes Yasargil 17 cm / 6 6/8" working length 150 mm Ø 2,0 mm	
2361	HMI-SI-2572	Suction Tubes Yasargil 17 cm / 6 6/8" working length 150 mm Ø 2,5 mm	
2362	HMI-SI-2573	Suction Tubes Yasargil 17 cm / 6 6/8" working length 150 mm Ø 3,5 mm	
2363	HMI-SI-2574	Suction Tubes Baby-Yankauer 21 cm / 8 2/8" Ø 8,0 mm	
2364	HMI-SI-2575	Suction Tubes Yankauer 31 cm / 12 2/8" complete, with suction tip and connector Ø 9,4 mm	
2365	HMI-SI-2576	Suction Tubes De Bakey-Adson Ø 4,0 mm 16 cm / 6 2/8"	
2366	HMI-SI-2577	Suction Tubes De Bakey-Adson Ø 4,0 mm 20 cm / 7 7/8"	

2367	HMI-SI-2578	Suction Tubes De Bakey-Adson Ø 9,0 mm 28 cm / 6 2/8"	
2368	HMI-SI-2579	Suction Tubes Yankauer complete, with handle, 4 tubes yg. 0/1/2/3, suction tip and tube connector 31 cm / 12 2/8"	
2369	HMI-SI-2580	Suction Tubes Yankauer complete Set consisting of: Handle 15 cm / 5 7/8"	
2370	HMI-SI-2581	Suction Tubes Yankauer complete Set consisting of: Olive 2,5 cm / 1"	
2371	HMI-SI-2582	Suction Tubes Yankauer complete Set consisting of 10 cm / 3 7/8" Ø2,5 mm	
2372	HMI-SI-2583	Suction Tubes Yankauer complete Set consisting of 10 cm / 3 7/8" Ø3,4 mm	
2373	HMI-SI-2584	Suction Tubes Yankauer complete Set consisting of 10 cm / 3 7/8" Ø2,5 mm	
2374	HMI-SI-2585	Suction Tubes Yankauer complete Set consisting of 10 cm / 3 7/8" Ø2,5 mm	

2375	HMI-SI-2586	Suction Tubes suction tip 9,9 mm	
2376	HMI-SI-2587	Suction Tubes Baby-Poole 19 cm / 7 4/8" Ø6,0 mm	
2377	HMI-SI-2588	Suction Tubes Baby-Poole 19 cm / 7 4/8" Ø6,0 mm	
2378	HMI-SI-2589	Suction Tubes Poole 24 cm / 9 4/8" Ø10 mm	
2379	HMI-SI-2590	Suction Tubes Poole 25 cm / 9 7/8" Ø8 mm	
2380	HMI-SI-2591	Suction Tubes House 17 cm / 6 6/8" Suction Tube Ø0,9 mm Irrigation tube Ø0,7 mm	
2381	HMI-SI-2592	Suction Tubes House 17 cm / 6 6/8" Suction Tube Ø1,2 mm Irrigation tube Ø0,9 mm	
2382	HMI-SI-2593	Suction Tubes House 17 cm / 6 6/8" Suction Tube Ø1,5 mm Irrigation tube Ø1,2 mm	





2383	HMI-SI-2594	Suction Tubes House Suction Adapter 4,5 cm / 1 6/8"	
2384	HMI-SI-2595	Suction Tubes Cooley 36 cm / 14 1/8" Ø8 mm	
2385	HMI-SI-2596	Suction Tubes Cooley with perforated screw tip 31 cm / 12 2/8" Ø10 mm	
2386	HMI-SI-2597	Suction Tubes Cooley with perforated screw tip 31 cm / 12 2/8" Ø7 mm	
2387	HMI-SI-2598	Suction Tubes Cooley with perforated screw tip 36 cm / 14 1/8" Ø8 mm	
2388	HMI-SI-2599	Suction Tubes with perforated screw tip 28 cm / 11" Ø6 mm	
2389	HMI-SI-2600	Suction Tubes with perforated screw tip 30 cm / 11 6/8" Ø6 mm	
2390	HMI-SI-2601	Suction Tubes Nuboer round opening 21 cm / 8 2/8" Ø6 mm	







2391	HMI-SI-2602	Suction Tubes Nuboer oval opening 21 cm / 8 2/8" Ø6 mm	
2392	HMI-SI-2603	Suction Tubes Jamieson 27 cm / 10 6/8" Ø0,5 mm	
2393	HMI-SI-2604	Suction Tubes Jamieson 27 cm / 10 6/8" Ø1,0 mm	
2394	HMI-SI-2605	Suction Tubes Jamieson 27 cm / 10 6/8" Ø1,5 mm	
2395	HMI-SI-2606	Suction Tubes Jamieson 27 cm / 10 6/8" Ø0,5 mm	
2396	HMI-SI-2607	Suction Tubes Jamieson 27 cm / 10 6/8" Ø1,0 mm	
2397	HMI-SI-2608	Suction Tubes Coupland Handle with connector 17 cm / 6 6/8"	
2398	HMI-SI-2609	Suction Tubes tip laterally perforated 9 cm / 3 4/8" Ø1,5 mm	
2399	HMI-SI-2610	Suction Tubes tip laterally perforated 9 cm / 3 4/8" Ø2,0 mm	
2400	HMI-SI-2611	Suction Tubes tip laterally perforated 9 cm / 3 4/8" Ø2,5 mm	





2401	HMI-SI-2612	Suction Tubes tip laterally perforated 9 cm / 3 4/8" Ø3,5 mm	
2402	HMI-SI-2613	Suction Tubes Byrd 21,5 cm / 8 4/8" Ø3,0 mm	 <p>HMI-SI-2613 Ø3,0 mm</p>  <p>HMI-SI-2614 Ø3,5 mm</p>  <p>HMI-SI-2615 Ø4,3 mm</p>
2403	HMI-SI-2614	Suction Tubes Byrd 21,5 cm / 8 4/8" Ø3,5 mm	
2404	HMI-SI-2615	Suction Tubes Byrd 21,5 cm / 8 4/8" Ø4,3 mm	
2405	HMI-SI-2616	Suction Tubes Cogswell with younger cut-off, 24,5 cm / 9 5/8" Ø3,8 mm	
2406	HMI-SI-2617	Guide Needles Redon threaded end 19,5 cm / 7 5/8" 8 CH	     
2407	HMI-SI-2618	Guide Needles Redon threaded end 19,5 cm / 7 5/8" 10 CH	
2408	HMI-SI-2619	Guide Needles Redon threaded end 19,5 cm / 7 5/8" 12 CH	
2409	HMI-SI-2620	Guide Needles Redon threaded end 19,5 cm / 7 5/8" 14 CH	
2410	HMI-SI-2621	Guide Needles Redon threaded end 19,5 cm / 7 5/8" 16 CH	
2411	HMI-SI-2622	Guide Needles Redon threaded end 19,5 cm / 7 5/8" 18 CH	
2412	HMI-SI-2623	Guide Needles Redon threaded end 19,5 cm / 7 5/8" 8 CH	



2413	HMI-SI-2624	Guide Needles Redon threaded end 19,5 cm / 7 5/8" 10 CH
2414	HMI-SI-2625	Guide Needles Redon threaded end 19,5 cm / 7 5/8" 12 CH
2415	HMI-SI-2626	Guide Needles Redon threaded end 19,5 cm / 7 5/8" 14 CH
2416	HMI-SI-2627	Guide Needles Redon threaded end 19,5 cm / 7 5/8" 16 CH
2417	HMI-SI-2628	Guide Needles Redon threaded end 19,5 cm / 7 5/8" 18 CH
2418	HMI-SI-2629	Guide Needles Redon threaded end 19,5 cm / 7 5/8" 8 CH
2419	HMI-SI-2630	Guide Needles Redon threaded end 19,5 cm / 7 5/8" 10 CH
2420	HMI-SI-2631	Guide Needles Redon threaded end 19,5 cm / 7 5/8" 12 CH
2421	HMI-SI-2632	Guide Needles Redon threaded end 19,5 cm / 7 5/8" 14 CH
2422	HMI-SI-2633	Guide Needles Redon threaded end 19,5 cm / 7 5/8" 16 CH
2423	HMI-SI-2634	Guide Needles Redon threaded end 19,5 cm / 7 5/8" 18 CH
2424	HMI-SI-2635	Guide Needles Redon threaded end 19,5 cm / 7 5/8" 8 CH
2425	HMI-SI-2636	Guide Needles Redon threaded end 19,5 cm / 7 5/8" 10 CH
2426	HMI-SI-2637	Guide Needles Redon threaded end 19,5 cm / 7 5/8" 12 CH
2427	HMI-SI-2638	Guide Needles Redon threaded end 19,5 cm / 7 5/8" 14 CH
2428	HMI-SI-2639	Guide Needles Redon threaded end 19,5 cm / 7 5/8" 16 CH













2429	HMI-SI-2640	Guide Needles Redon threaded end 19,5 cm / 7 5/8" 18 CH	
2430	HMI-SI-2641	Hypodermic Needles Luer Lock connection 18 cm / 7" Pudendus Anaesthesia Needle complete with needle Ø 1,00 x 185 mm	
2431	HMI-SI-2642	Hypodermic Needles Luer Lock connection 18 cm / 7" Cannula Ø 1,00 x 185 mm	
2432	HMI-SI-2643	Hypodermic Needles Vein Cannulas 1,2 x 80 mm	
2433	HMI-SI-2644	Hypodermic Needles Vein Cannulas 1,5 x 80 mm	
2434	HMI-SI-2645	Hypodermic Needles Heparin Flushing Needle, Luer Lock connection 2,0 x 45 mm	
2435	HMI-SI-2646	Hypodermic Needles Heparin Flushing Needle, Luer Lock connection 3,0 x 45 mm	
2436	HMI-SI-2647	Hypodermic Needles Heparin Flushing Needle, Luer Lock connection 3,7 x 55 mm	
2437	HMI-SI-2648	Hypodermic Needles Heparin Flushing Needle, Luer Lock connection 5,0 x 60 mm	
2438	HMI-SI-2649	Hypodermic Needles Heparin Flushing Needle, Luer Lock connection 2,9 x 65 mm	
2439	HMI-SI-2650	Special Needles Tuohy Lumbar Puncture Needle with special tip, Luer-Lock connection working length 76 mm Ø1,2 mm	

2440	HMI-SI-2651	Special Needles Tuohy Lumbar Puncture Needle with special tip, Luer-Lock connection working length 76 mm Ø1,4 mm	 
2441	HMI-SI-2652	Special Needles Tuohy Lumbar Puncture Needle with special tip, Luer-Lock connection working length 76 mm Ø1,6 mm	
2442	HMI-SI-2653	Special Needles Verhoeven Suction cannula 10 cm / 3 7/8" Ø1,5 mm	
2443	HMI-SI-2654	Special Needles Luer Lock connection tapered tip	
2444	HMI-SI-2655	Special Needles Luer Lock connection tapered tip	
2445	HMI-SI-2656	Special Needles Tonsil cannula, Luer Lock connection tapered tip Ø0,65 mm	
2446	HMI-SI-2657	Special Needles Tonsil cannula, angled Ø1,0 mm	
2447	HMI-SI-2658	Special Needles Tonsil cannula, angled Ø1,3 mm	

2448	HMI-SI-2659	Suction Cannulas, Hypodermic Needles Plester Suction cannula 19,5 cm / 7 5/8" Ø1,5 mm	
2449	HMI-SI-2660	Suction Cannulas, Hypodermic Needles Plester Suction cannula 19,5 cm / 7 5/8" Ø2,0 mm	
2450	HMI-SI-2661	Suction Cannulas, Hypodermic Needles Plester Suction cannula 19,5 cm / 7 5/8" Ø2,5 mm	
2451	HMI-SI-2662	Suction Cannulas, Hypodermic Needles Plester Suction cannula 19,5 cm / 7 5/8" Ø3,0 mm	
2452	HMI-SI-2663	Suction Cannulas, Hypodermic Needles Suction cannula, malleable 16 cm / 6 2/8" Ø1,5 mm	
2453	HMI-SI-2664	Suction Cannulas, Hypodermic Needles Suction cannula, malleable 16 cm / 6 2/8" Ø2 mm	
2454	HMI-SI-2665	Suction Cannulas, Hypodermic Needles Verres Insu°ation Cannula working length 100 mm Ø2 mm	
2455	HMI-SI-2666	Suction Cannulas, Hypodermic Needles Verres Insu°ation Cannula working length 120 mm Ø2 mm	
2456	HMI-SI-2667	Suction Cannulas, Hypodermic Needles Vollmar 6 cm / 2 3/8" Ø1,5 mm	
2457	HMI-SI-2668	Suction Cannulas, Hypodermic Needles Vollmar 6 cm / 2 3/8" Ø2,0 mm	
2458	HMI-SI-2669	Suction Cannulas, Hypodermic Needles Vollmar 6 cm / 2 3/8" Ø2,5 mm	





2459	HMI-SI-2670	Suction Cannulas, Hypodermic Needles Vollmar 6 cm / 2 3/8" Ø3,0 mm	
2460	HMI-SI-2671	Suction Cannulas, Hypodermic Needles Vollmar 6 cm / 2 3/8" Ø4,0 mm	
2461	HMI-SI-2672	Vessel Irrigation Cannulas, Liver Puncture Needles Schmid malleable, Luer-Lock connection 15 cm / 5 7/8" Ø3,0 mm	
2462	HMI-SI-2673	Vessel Irrigation Cannulas, Liver Puncture Needles Schmid malleable, Luer-Lock connection 15 cm / 5 7/8" Ø4,0 mm	
2463	HMI-SI-2674	Vessel Irrigation Cannulas, Liver Puncture Needles Schmid malleable, Luer-Lock connection 15 cm / 5 7/8" Ø5,0 mm	
2464	HMI-SI-2675	Vessel Irrigation Cannulas, Liver Puncture Needles Schmid malleable, Luer-Lock connection 15 cm / 5 7/8" Ø6,0 mm	
2465	HMI-SI-2676	Vessel Irrigation Cannulas, Liver Puncture Needles Mock Heparin Flushing Needle, Luer Lock connection 6,5 cm / 2 4/8" Ø2,9 x 0,8 mm button-ended	
2466	HMI-SI-2677	Vessel Irrigation Cannulas, Liver Puncture Needles Menghini for liver blind puncture, with stopping probe working length 35 mm Ø1,0 mm	
2467	HMI-SI-2678	Vessel Irrigation Cannulas, Liver Puncture Needles Menghini for liver blind puncture, with stopping probe working length 70 mm Ø1,0 mm	
2468	HMI-SI-2679	Vessel Irrigation Cannulas, Liver Puncture Needles Menghini for liver blind puncture, with stopping probe working length 70 mm Ø1,2 mm	





2469	HMI-SI-2680	Vessel Irrigation Cannulas, Liver Puncture Needles Menghini for liver blind puncture, with stopping probe working length 100 mm Ø1,2 mm	
2470	HMI-SI-2681	Vessel Irrigation Cannulas, Liver Puncture Needles Menghini for liver blind puncture, with stopping probe working length 70 mm Ø1,4 mm	
2471	HMI-SI-2682	Vessel Irrigation Cannulas, Liver Puncture Needles Menghini for liver blind puncture, with stopping probe working length 100 mm Ø1,4 mm	
2472	HMI-SI-2683	Vessel Irrigation Cannulas, Liver Puncture Needles Menghini for liver blind puncture, with stopping probe working length 70 mm Ø1,6 mm	
2473	HMI-SI-2684	Vessel Irrigation Cannulas, Liver Puncture Needles Menghini for liver blind puncture, with stopping probe working length 100 mm Ø1,8 mm	
2474	HMI-SI-2685	Vessel Irrigation Cannulas, Liver Puncture Needles Menghini for controlled liver blind puncture working length 168 mm Ø1,8 mm	
2475	HMI-SI-2686	Connecting Pieces Connector LL = female, RC = male	
2476	HMI-SI-2687	Connecting Pieces Connector RC = female, Luer = male	







2477	HMI-SI-2688	Connecting Pieces Connector LL = male	
2478	HMI-SI-2689	Connecting Pieces Connector LL = female	
2479	HMI-SI-2610(a)	Connecting Pieces Catheter Fitting, conical Luer-Lock connection = female Ø2,5 / 4,0 mm	
2480	HMI-SI-2611(a)	Connecting Pieces Catheter Fitting, conical Luer-Lock connection = female Ø 2,5 / 6,5 mm	
2481	HMI-SI-2612(a)	Connecting Pieces Catheter Fitting, conical Luer-Lock connection = female Ø3,0 / 9,0 mm	
2482	HMI-SI-2613(a)	Connecting Pieces Urethral Olive LL = female	
2483	HMI-SI-2614(a)	Connecting Pieces Urethral Olive LL = female	
2484	HMI-SI-2614(b)	Connecting Pieces 3-Way Stopcock 1 x LL male, 2 x LL = female	
2485	HMI-SI-2614(c)	Connecting Pieces Connector for trachea tubes Ø 3,0 mm	
2486	HMI-SI-2614(d)	Connecting Pieces Connector for trachea tubes Ø 4,0 mm	









2487	HMI-SI-2614(e)	Connecting Pieces Connector for trachea tubes Ø 5,0 mm
2488	HMI-SI-2614(f)	Connecting Pieces Connector for trachea tubes Ø 6,0 mm
2489	HMI-SI-2614(g)	Connecting Pieces Connector for trachea tubes Ø 7,0 mm
2490	HMI-SI-2614(h)	Connecting Pieces Connector for trachea tubes Ø8,0 mm
2491	HMI-SI-2614(i)	Connecting Pieces Connector for trachea tubes Ø 9,0 mm
2492	HMI-SI-2614(j)	Connecting Pieces Connector for trachea tubes Ø 10,0 mm
2493	HMI-SI-2614(k)	Connecting Pieces Connector for trachea tubes Ø 11,0 mm
2494	HMI-SI-2614(l)	Connecting Pieces Connector for trachea tubes Ø 12,0 mm
2495	HMI-SI-2614(m)	Connecting Pieces Connector for trachea tubes Ø 13,0 mm
2496	HMI-SI-2615(a)	Connecting Pieces Glass barrel, with Luer-connection 1 ml
2497	HMI-SI-2616(a)	Connecting Pieces Glass barrel, with Luer-connection 2 ml
2498	HMI-SI-2617(a)	Connecting Pieces Glass barrel, with Luer-connection 5 ml
2499	HMI-SI-2618(a)	Connecting Pieces Glass barrel, with Luer-connection 10 ml
2500	HMI-SI-2619(a)	Connecting Pieces Glass barrel, with Luer-connection 20 ml























2501	HMI-SI-2620(a)	Connecting Pieces Glass barrel, with Luer-connection 50 ml	
2502	HMI-SI-2621(a)	Connecting Pieces Spare Barrels, with Luer-connection 1 ml	
2503	HMI-SI-2622(a)	Connecting Pieces Spare Barrels, with Luer-connection 2 ml	
2504	HMI-SI-2623(a)	Connecting Pieces Spare Barrels, with Luer-connection 5 ml	
2505	HMI-SI-2624(a)	Connecting Pieces Spare Barrels, with Luer-connection 10 ml	
2506	HMI-SI-2625(a)	Connecting Pieces Spare Barrels, with Luer-connection 20 ml	
2507	HMI-SI-2626(a)	Connecting Pieces Spare Barrels, with Luer-connection 50 ml	
2508	HMI-SI-2627(a)	Connecting Pieces Glass barrel, with Luer-connection 1 ml	
2509	HMI-SI-2628(a)	Connecting Pieces Glass barrel, with Luer-connection 2 ml	
2510	HMI-SI-2629(a)	Connecting Pieces Glass barrel, with Luer-connection 5 ml	
2511	HMI-SI-2630(a)	Connecting Pieces Glass barrel, with Luer-connection 10 ml	
2512	HMI-SI-2631(a)	Connecting Pieces Glass barrel, with Luer-connection 20 ml	
2513	HMI-SI-2632(a)	Connecting Pieces Glass barrel, with Luer-connection 50 ml	
2514	HMI-SI-2633(a)	Connecting Pieces Spare Barrels, with Luer-connection 1 ml	
2515	HMI-SI-2634(a)	Connecting Pieces Spare Barrels, with Luer-connection 2 ml	
2516	HMI-SI-2635(a)	Connecting Pieces Spare Barrels, with Luer-connection 5 ml	



2517	HMI-SI-2636(a)	Connecting Pieces Spare Barrels, with Luer-connection 10 ml	
2518	HMI-SI-2637(a)	Connecting Pieces Spare Barrels, with Luer-connection 20 ml	
2519	HMI-SI-2638(a)	Connecting Pieces Spare Barrels, with Luer-connection 50 ml	
2520	HMI-SI-2639(a)	Suction Tubes 3-Ring Syringe Glass barrel, Luer Lock connection moveable rings 2 ml	
2521	HMI-SI-2640(a)	Suction Tubes 3-Ring Syringe Glass barrel, Luer Lock connection moveable rings 5 ml	
2522	HMI-SI-2641(a)	Suction Tubes 3-Ring Syringe Glass barrel, Luer Lock connection moveable rings 10 ml	
2523	HMI-SI-2642(a)	Suction Tubes Spare Barrel Luer Lock connection 2 ml	
2524	HMI-SI-2643(a)	Suction Tubes Spare Barrel Luer Lock connection 5 ml	
2525	HMI-SI-2644(a)	Suction Tubes Spare Barrel Luer Lock connection 10 ml	
2526	HMI-SI-2645(a)	Suction Tubes Insulin Syringe Glass barrel, with Luer-connection 1 ml / 40 E	
2527	HMI-SI-2646(a)	Suction Tubes Insulin Syringe Glass barrel, with Luer-connection 2 ml / 80 E	
2528	HMI-SI-2647(a)	Suction Tubes Spare Barrels, with Luer-connection 1 ml / 40 E	







2529	HMI-SI-2648(a)	Suction Tubes Spare Barrels, with Luer-connection 2 ml / 80 E	
2530	HMI-SI-2649(a)	Hypodermic Syringes Tuberculin Syringe Glass barrel, Luer-Lock	
2531	HMI-SI-2649(b)	Hypodermic Syringes Spare Barrels, Luer-Lock	
2532	HMI-SI-2650(a)	Wound and Bladder Syringes Janet complete, glass barrel, with two exchangeable tips 50 ml	
2533	HMI-SI-2651(a)	Wound and Bladder Syringes Janet complete, glass barrel, with two exchangeable tips 100 ml	
2534	HMI-SI-2652(a)	Wound and Bladder Syringes Janet complete, glass barrel, with two exchangeable tips 150 ml	
2535	HMI-SI-2653(a)	Wound and Bladder Syringes Janet complete, glass barrel, with two exchangeable tips 200 ml	
2536	HMI-SI-2654(a)	Wound and Bladder Syringes Janet Spare Barrel 50 ml	
2537	HMI-SI-2655(a)	Wound and Bladder Syringes Janet Spare Barrel 100 ml	
2538	HMI-SI-2656(a)	Wound and Bladder Syringes Janet Spare Barrel 150 ml	
2539	HMI-SI-2657(a)	Wound and Bladder Syringes Janet Spare Barrel 200 ml	
2540	HMI-SI-2658(a)	Catheter Introducing Forceps Magill 15,5 cm / 6 1/8" for babies	







2541	HMI-SI-2659(a)	Catheter Introducing Forceps Magill 17,5 cm / 6 7/8" for children	
2542	HMI-SI-2660(a)	Catheter Introducing Forceps Magill 20 cm / 7 7/8" for adults	
2543	HMI-SI-2661(a)	Laryngoscopes and Accessories Miller Set with battery handle (without batteries) and three laryngoscope blades fig. 1 to 3, complete, in case	      
2544	HMI-SI-2662(a)	Laryngoscopes and Accessories Miller Set with battery handle (without batteries) and four laryngoscope blades fig. 1 to 4, complete, in case	
2545	HMI-SI-2663(a)	Laryngoscopes and Accessories Miller-Baby Set with battery handle (without batteries) and two laryngoscope blades fig. 0 and 1, complete, in case	
2546	HMI-SI-2664(a)	Laryngoscopes and Accessories Miller/Miller-Baby for babies working length 55 mm	
2547	HMI-SI-2665(a)	Laryngoscopes and Accessories Miller/Miller-Baby for children working length 80 mm	
2548	HMI-SI-2666(a)	Laryngoscopes and Accessories Miller/Miller-Baby for adolescents working length 130 mm	
2549	HMI-SI-2667(a)	Laryngoscopes and Accessories Miller/Miller-Baby for women working length 170 mm	
2550	HMI-SI-2668(a)	Laryngoscopes and Accessories Miller/Miller-Baby for men working length 180 mm	
2551	HMI-SI-2669(a)	Laryngoscopes and Accessories Guedel-Negus Set with battery handle (without batteries) and three laryngoscope blades fig. 2 to 4, complete, in case	





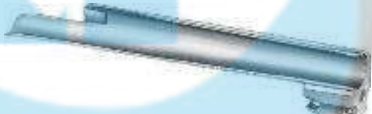

2552	HMI-SI-2670(a)	Laryngoscopes and Accessories Guedel-Negus Set with battery handle (without batteries) and four laryngoscope blades ýg. 1 to 4, complete, in case	
2553	HMI-SI-2671(a)	Laryngoscopes and Accessories Guedel-Negus Set for children working length 70 mm	
2554	HMI-SI-2672(a)	Laryngoscopes and Accessories Guedel-Negus Set for adolescents working length 90 mm	
2555	HMI-SI-2673(a)	Laryngoscopes and Accessories Guedel-Negus Set for women working length 110 mm	
2556	HMI-SI-2674(a)	Laryngoscopes and Accessories Guedel-Negus Set for men working length 135 mm	
2557	HMI-SI-2675(a)	Laryngoscopes and Accessories McIntosh Set with battery handle (without batteries) and three laryngoscope blades ýg. 1 to 3, complete, in case	
2558	HMI-SI-2676(a)	Laryngoscopes and Accessories McIntosh Set with battery handle (without batteries) and four laryngoscope blades ýg. 1 to 4, complete, in case	
2559	HMI-SI-2677(a)	Laryngoscopes and Accessories McIntosh Set for babies working length 55 mm	
2560	HMI-SI-2678(a)	Laryngoscopes and Accessories McIntosh Set for children working length 75 mm	
2561	HMI-SI-2679(a)	Laryngoscopes and Accessories McIntosh Set for adolescents working length 90 mm	
2562	HMI-SI-2680(a)	Laryngoscopes and Accessories McIntosh Set for women working length 110 mm	







2563	HMI-SI-2681(a)	Laryngoscopes and Accessories McIntosh Set for men working length 135 mm	
2564	HMI-SI-2682(a)	Laryngoscopes and Accessories Foregger Set with battery handle (without batteries) and three laryngoscope blades ýg. 2 to 4, complete, in case	    
2565	HMI-SI-2683(a)	Laryngoscopes and Accessories Foregger Set with battery handle (without batteries) and three laryngoscope blades ýg. 2 to 4, complete, in case	
2566	HMI-SI-2684(a)	Laryngoscopes and Accessories Foregger for children working length 70 mm	
2567	HMI-SI-2685(a)	Laryngoscopes and Accessories Foregger for adolescents working length 90 mm	
2568	HMI-SI-2686(a)	Laryngoscopes and Accessories Foregger for women working length 110 mm	
2569	HMI-SI-2687(a)	Laryngoscopes and Accessories Foregger for men working length 135 mm	
2570	HMI-SI-2688(a)	Laryngoscopes and Accessories Handle for warm light blade and two type C batteries (batteries not included)	
2571	HMI-SI-2689(a)	Laryngoscopes and Accessories Spare bulb large, for blades	 
2572	HMI-SI-2690	Laryngoscopes and Accessories Spare bulb small, for blades	



2573	HMI-SI-2691	Laryngoscopes and Accessories Case for Laryngoscopes (warm light and cold light) for three straight laryngoscope blades	
2574	HMI-SI-2692	Laryngoscopes and Accessories Case for Laryngoscopes (warm light and cold light) for four straight laryngoscope blades	
2575	HMI-SI-2693	Laryngoscopes and Accessories Case for Laryngoscopes (warm light and cold light) for three curved laryngoscope blades	
2576	HMI-SI-2694	Laryngoscopes and Accessories Case for Laryngoscopes (warm light and cold light) for four curved laryngoscope blades	
2577	HMI-SI-2695	Fiber Optic Laryngoscopes and Accessories McIntosh Set with battery handle 19-600-00-02 (without batteries) and three laryngoscope blades ýg. 1 to 3, complete, in case	
2578	HMI-SI-2696	Fiber Optic Laryngoscopes and Accessories Set with inductive accumulator handle and three laryngoscope blades ýg. 1 to 3, complete, in case	
2579	HMI-SI-2697	Fiber Optic Laryngoscopes and Accessories McIntosh Set with battery handle (without batteries) and four laryngoscope blades ýg. 1 to 4, complete, in case	
2580	HMI-SI-2698	Fiber Optic Laryngoscopes and Accessories McIntosh Set with inductive accumulator handle and four laryngoscope blades ýg. 1 to 4, complete, in case	

2581	HMI-SI-2699	Fiber Optic Laryngoscopes and Accessories for babies working length 55 mm	
2582	HMI-SI-2700	Fiber Optic Laryngoscopes and Accessories for children working length 70 mm	
2583	HMI-SI-2701	Fiber Optic Laryngoscopes and Accessories for adolescents working length 85 mm	
2584	HMI-SI-2702	Fiber Optic Laryngoscopes and Accessories for women working length 105 mm	
2585	HMI-SI-2703	Fiber Optic Laryngoscopes and Accessories for men working length 130 mm	
2586	HMI-SI-2704	Fiber Optic Laryngoscopes and Accessories Set with battery handle (without batteries) and three laryngoscope blades ýg. 2 to 4, complete, in case	
2587	HMI-SI-2705	Fiber Optic Laryngoscopes and Accessories Set with inductive accumulator handle and three laryngoscope blades ýg. 2 to 4, complete, in case	
2588	HMI-SI-2706	Fiber Optic Laryngoscopes and Accessories Set with battery handle (without batteries) and four laryngoscope blades ýg. 1 to 4, complete, in case	

2589	HMI-SI-2707	Fiber Optic Laryngoscopes and Accessories Set with inductive accumulator handle and four laryngoscope blades ýg. 1 to 4, complete, in case	
2590	HMI-SI-2708	Fiber Optic Laryngoscopes and Accessories for babies working length 55 mm	
2591	HMI-SI-2709	Fiber Optic Laryngoscopes and Accessories for children working length 70 mm	
2592	HMI-SI-2710	Fiber Optic Laryngoscopes and Accessories for adolescents working length 90 mm	
2593	HMI-SI-2711	Fiber Optic Laryngoscopes and Accessories for women working length 110 mm	
2594	HMI-SI-2712	Fiber Optic Laryngoscopes and Accessories for men working length 135 mm	
2595	HMI-SI-2713	Fiber Optic Laryngoscopes and Accessories miller Set with battery handle (without batteries) and three laryngoscope blades ýg. 1 to 3, complete, in case	
2596	HMI-SI-2714	Fiber Optic Laryngoscopes and Accessories Miller Set with inductive accumulator handle and three laryngoscope blades ýg. 1 to 3, complete, in case	





2597	HMI-SI-2715	Fiber Optic Laryngoscopes and Accessories Miller Set with battery handle (without batteries) and four laryngoscope blades ýg. 1 to 4, complete, in case	
2598	HMI-SI-2716	Fiber Optic Laryngoscopes and Accessories Miller Set with induktiv accumulator handle and four laryngoscope blades ýg. 1 to 4, complete, in case	
2599	HMI-SI-2717	Fiber Optic Laryngoscopes and Accessories for babies working length 55 mm	
2600	HMI-SI-2718	Fiber Optic Laryngoscopes and Accessories for children working length 80 mm	
2601	HMI-SI-2719	Fiber Optic Laryngoscopes and Accessories for adolescents working length 130 mm	
2602	HMI-SI-2720	Fiber Optic Laryngoscopes and Accessories for women working length 170 mm	
2603	HMI-SI-2721	Fiber Optic Laryngoscopes and Accessories for men working length 189 mm	
2604	HMI-SI-2722	Fiber Optic Laryngoscopes and Accessories Spare Bulb Krypton, 2,5 V	

2605	HMI-SI-2723	Fiber Optic Laryngoscopes and Accessories Spare Bulb Xenon, 2,5 V	
2606	HMI-SI-2724	Fiber Optic Laryngoscopes and Accessories Handle with battery container for two type C batteries (batteries not included) for cold light blade, with xenon lamp, 2.5 V	
2607	HMI-SI-2725	Fiber Optic Laryngoscopes and Accessories Battery container for two type C batteries (batteries not included)	
2608	HMI-SI-2726	Fiber Optic Laryngoscopes and Accessories Handle with battery container for two type AA batteries (batteries not included)	
2609	HMI-SI-2727	Fiber Optic Laryngoscopes and Accessories Handle Battery container for two type AA batteries (batteries not included)	
2610	HMI-SI-2728	Fiber Optic Laryngoscopes and Accessories Handle with inductive accumulator insert 19-610-00-04 and high power LED (> 50,000 lux)	
2611	HMI-SI-2729	Fiber Optic Laryngoscopes and Accessories Inductive accumulator insert with lithium-ion accumulator and high power LED (> 50,000 lux)	
2612	HMI-SI-2730	Fiber Optic Laryngoscopes and Accessories Handle with inductive accumulator insert 19-611-00-04 and xenon lamp, 2.5 V	

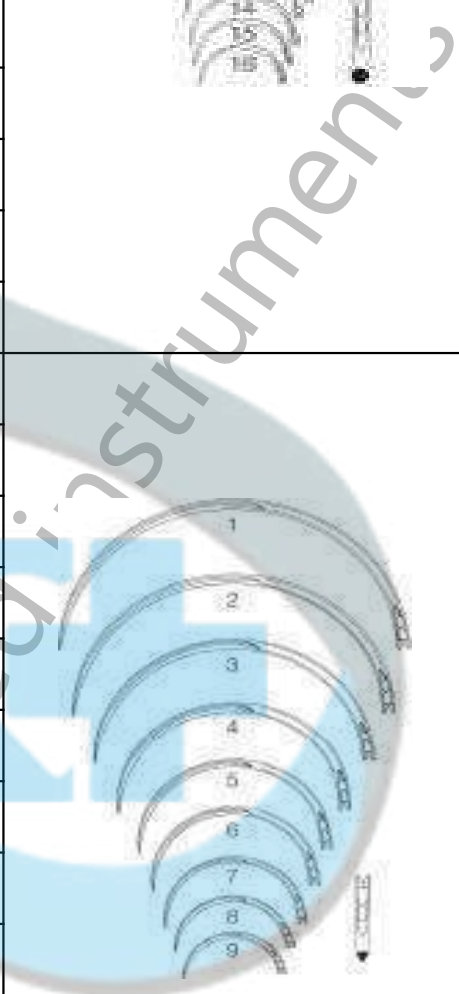
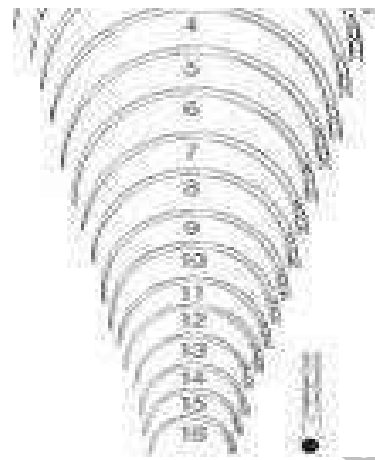
2613	HMI-SI-2731	Fiber Optic Laryngoscopes and Accessories Inductive accumulator insert (without bulb)	
2614	HMI-SI-2732	Surgical Needles curved, 1/2 circle, SU = 12/pack 1	
2615	HMI-SI-2733	Surgical Needles curved, 1/2 circle, SU = 12/pack 2	
2616	HMI-SI-2734	Surgical Needles curved, 1/2 circle, SU = 12/pack 3	
2617	HMI-SI-2735	Surgical Needles curved, 1/2 circle, SU = 12/pack 4	
2618	HMI-SI-2736	Surgical Needles curved, 1/2 circle, SU = 12/pack 5	
2619	HMI-SI-2737	Surgical Needles curved, 1/2 circle, SU = 12/pack 6	
2620	HMI-SI-2738	Surgical Needles curved, 1/2 circle, SU = 12/pack 7	
2621	HMI-SI-2739	Surgical Needles curved, 1/2 circle, SU = 12/pack 8	
2622	HMI-SI-2740	Surgical Needles curved, 1/2 circle, SU = 12/pack 9	
2623	HMI-SI-2741	Surgical Needles curved, 1/2 circle, SU = 12/pack 10	
2624	HMI-SI-2742	Surgical Needles curved, 1/2 circle, SU = 12/pack 11	
2625	HMI-SI-2743	Surgical Needles curved, 1/2 circle, SU = 12/pack 12	
2626	HMI-SI-2744	Surgical Needles curved, 1/2 circle, SU = 12/pack 13	
2627	HMI-SI-2745	Surgical Needles curved, 1/2 circle, SU = 12/pack 14	
2628	HMI-SI-2746	Surgical Needles curved, 1/2 circle, SU = 12/pack 15	
2629	HMI-SI-2747	Surgical Needles curved, 1/2 circle, SU = 12/pack 16	
2630	HMI-SI-2748	Surgical Needles curved, 1/2 circle, SU = 12/pack 1	
2631	HMI-SI-2749	Surgical Needles curved, 1/2 circle, SU = 12/pack 2	
2632	HMI-SI-2750	Surgical Needles curved, 1/2 circle, SU = 12/pack 3	
2633	HMI-SI-2751	Surgical Needles curved, 1/2 circle, SU = 12/pack 4	
2634	HMI-SI-2752	Surgical Needles curved, 1/2 circle, SU = 12/pack 5	
2635	HMI-SI-2753	Surgical Needles curved, 1/2 circle, SU = 12/pack 6	

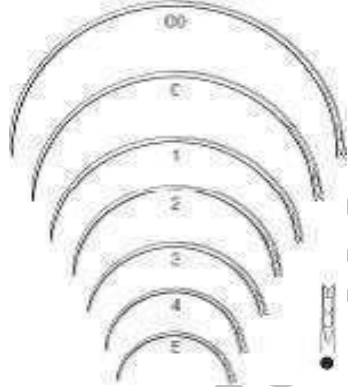
2636	HMI-SI-2754	Surgical Needles curved, 1/2 circle, SU = 12/pack 7
2637	HMI-SI-2755	Surgical Needles curved, 1/2 circle, SU = 12/pack 8
2638	HMI-SI-2756	Surgical Needles curved, 1/2 circle, SU = 12/pack 9
2639	HMI-SI-2757	Surgical Needles curved, 1/2 circle, SU = 12/pack 10
2640	HMI-SI-2758	Surgical Needles curved, 1/2 circle, SU = 12/pack 11
2641	HMI-SI-2759	Surgical Needles curved, 1/2 circle, SU = 12/pack 12
2642	HMI-SI-2760	Surgical Needles curved, 1/2 circle, SU = 12/pack 13
2643	HMI-SI-2761	Surgical Needles curved, 1/2 circle, SU = 12/pack 14
2644	HMI-SI-2762	Surgical Needles curved, 1/2 circle, SU = 12/pack 15
2645	HMI-SI-2763	Surgical Needles curved, 1/2 circle, SU = 12/pack 16
2646	HMI-SI-2764	Surgical Needles curved, 1/2 circle, SU = 12/pack 1
2647	HMI-SI-2765	Surgical Needles curved, 1/2 circle, SU = 12/pack 2
2648	HMI-SI-2766	Surgical Needles curved, 1/2 circle, SU = 12/pack 3
2649	HMI-SI-2767	Surgical Needles curved, 1/2 circle, SU = 12/pack 4
2650	HMI-SI-2768	Surgical Needles curved, 1/2 circle, SU = 12/pack 5
2651	HMI-SI-2769	Surgical Needles curved, 1/2 circle, SU = 12/pack 6
2652	HMI-SI-2770	Surgical Needles curved, 1/2 circle, SU = 12/pack 7
2653	HMI-SI-2771	Surgical Needles curved, 1/2 circle, SU = 12/pack 8
2654	HMI-SI-2772	Surgical Needles curved, 1/2 circle, SU = 12/pack 9
2655	HMI-SI-2773	Surgical Needles curved, 1/2 circle, SU = 12/pack 0
2656	HMI-SI-2774	Surgical Needles curved, 1/2 circle, SU = 12/pack 00
2657	HMI-SI-2775	Surgical Needles curved, 1/2 circle, SU = 12/pack 00
2658	HMI-SI-2776	Surgical Needles curved, 1/2 circle, SU = 12/pack 1
2659	HMI-SI-2777	Surgical Needles curved, 1/2 circle, SU = 12/pack 2
2660	HMI-SI-2778	Surgical Needles curved, 1/2 circle, SU = 12/pack 3



2661	HMI-SI-2779	Surgical Needles curved, 1/2 circle, SU = 12/pack 4	
2662	HMI-SI-2780	Surgical Needles curved, 1/2 circle, SU = 12/pack 5	
2663	HMI-SI-2781	Surgical Needles Pb curved, 1/2 circle, SU = 12/pack 0	
2664	HMI-SI-2782	Surgical Needles Pb curved, 1/2 circle, SU = 12/pack 00	
2665	HMI-SI-2783	Surgical Needles Pb curved, 1/2 circle, SU = 12/pack 1	
2666	HMI-SI-2784	Surgical Needles Pb curved, 1/2 circle, SU = 12/pack 2	
2667	HMI-SI-2785	Surgical Needles Pb curved, 1/2 circle, SU = 12/pack 3	
2668	HMI-SI-2786	Surgical Needles Pb curved, 1/2 circle, SU = 12/pack 4	
2669	HMI-SI-2787	Surgical Needles Pb curved, 1/2 circle, SU = 12/pack 5	
2670	HMI-SI-2788	Surgical Needles Eye Needle curved, 1/2 circle, SU = 12/pack 1	
2671	HMI-SI-2789	Surgical Needles Eye Needle curved, 1/2 circle, SU = 12/pack 2	
2672	HMI-SI-2790	Surgical Needles Eye Needle curved, 1/2 circle, SU = 12/pack 3	
2673	HMI-SI-2791	Surgical Needles Eye Needle curved, 1/2 circle, SU = 12/pack 4	
2674	HMI-SI-2792	Surgical Needles Eye Needle curved, 1/2 circle, SU = 12/pack 5	
2675	HMI-SI-2793	Micro Needle Holders 15 cm / 5 7/8" with ratchet \varnothing 0.30 mm	
2676	HMI-SI-2794	Micro Needle Holders 15 cm / 5 7/8" with ratchet \varnothing 0.30 mm	
2677	HMI-SI-2795	Micro Needle Holders 15 cm / 5 7/8" w/o ratchet \varnothing 0.30 mm	
2678	HMI-SI-2796	Micro Needle Holders 15 cm / 5 7/8" w/o ratchet \varnothing 0.30 mm	
2679	HMI-SI-2797	Micro Needle Holders Castroviejo 15 cm / 5 7/8" with ratchet \varnothing 0.30 mm	 

2680	HMI-SI-2798	Micro Needle Holders Castroviejo 15 cm / 5 7/8" with ratchet \emptyset 0.30 mm
2681	HMI-SI-2799	Micro Needle Holders Castroviejo 15 cm / 5 7/8" w/o ratchet \emptyset 0.30 mm
2682	HMI-SI-2800	Micro Needle Holders Castroviejo 15 cm / 5 7/8" w/o ratchet \emptyset 0.30 mm
2683	HMI-SI-2801	Micro Needle Holders Castroviejo St 15 cm / 5 7/8" with ratchet \emptyset 0.40 mm
2684	HMI-SI-2802	Micro Needle Holders Castroviejo St 15 cm / 5 7/8" with ratchet \emptyset 0.40 mm
2685	HMI-SI-2803	Micro Needle Holders Castroviejo St 15 cm / 5 7/8" w/o ratchet \emptyset 0.40 mm
2686	HMI-SI-2804	Micro Needle Holders Castroviejo St 15 cm / 5 7/8" w/o ratchet \emptyset 0.40 mm
2687	HMI-SI-2805	Micro Needle Holders Castroviejo Ti 15 cm / 5 7/8" with ratchet \emptyset 0.40 mm
2688	HMI-SI-2806	Micro Needle Holders Castroviejo Ti 15 cm / 5 7/8" with ratchet \emptyset 0.40 mm
2689	HMI-SI-2807	Micro Needle Holders Castroviejo Ti 15 cm / 5 7/8" w/o ratchet \emptyset 0.40 mm



Healmed Instruments

2690	HMI-SI-2808	Micro Needle Holders Castroviejo Ti 15 cm / 5 7/8" w/o ratchet Ø 0.40 mm
2691	HMI-SI-2809	Micro Needle Holders Castroviejo St 18 cm / 7 1/8" with ratchet Ø 0.40 mm
2692	HMI-SI-2810	Micro Needle Holders Castroviejo St 18 cm / 7 1/8" with ratchet Ø 0.40 mm
2693	HMI-SI-2811	Micro Needle Holders Castroviejo St 18 cm / 7 1/8" w/o ratchet Ø 0.40 mm
2694	HMI-SI-2812	Micro Needle Holders Castroviejo St 18 cm / 7 1/8" w/o ratchet Ø 0.40 mm
2695	HMI-SI-2813	Micro Needle Holders Castroviejo Ti 18 cm / 7 1/8" with ratchet Ø 0.40 mm
2696	HMI-SI-2814	Micro Needle Holders Castroviejo Ti 18 cm / 7 1/8" with ratchet Ø 0.40 mm
2697	HMI-SI-2815	Micro Needle Holders Castroviejo Ti 18 cm / 7 1/8" w/o ratchet Ø 0.40 mm
2698	HMI-SI-2816	Micro Needle Holders Castroviejo Ti 18 cm / 7 1/8" w/o ratchet Ø 0.40 mm
2699	HMI-SI-2817	Micro Needle Holders Castroviejo St 18 cm / 7 1/8" with ratchet Ø 0.40 mm
2700	HMI-SI-2818	Micro Needle Holders Castroviejo St 18 cm / 7 1/8" with ratchet Ø 0.40 mm
2701	HMI-SI-2819	Micro Needle Holders Castroviejo St 18 cm / 7 1/8" w/o ratchet Ø 0.40 mm
2702	HMI-SI-2820	Micro Needle Holders Castroviejo St 18 cm / 7 1/8" w/o ratchet Ø 0.40 mm
2703	HMI-SI-2821	Micro Needle Holders Castroviejo Ti 18 cm / 7 1/8" with ratchet Ø 0.40 mm



2704	HMI-SI-2822	Micro Needle Holders Castroviejo Ti 18 cm / 7 1/8" with ratchet Ø 0.40 mm
2705	HMI-SI-2823	Micro Needle Holders Castroviejo Ti 18 cm / 7 1/8" w/o ratchet Ø 0.40 mm
2706	HMI-SI-2824	Micro Needle Holders Castroviejo Ti 18 cm / 7 1/8" w/o ratchet Ø 0.40 mm
2707	HMI-SI-2825	Micro Needle Holders 15 cm / 5 7/8" St with ratchet Ø 0.80 mm
2708	HMI-SI-2826	Micro Needle Holders 15 cm / 5 7/8" St with ratchet Ø 0.80 mm
2709	HMI-SI-2827	Micro Needle Holders 15 cm / 5 7/8" St w/o ratchet Ø 0.80 mm
2710	HMI-SI-2828	Micro Needle Holders 15 cm / 5 7/8" St w/o ratchet Ø 0.80 mm
2711	HMI-SI-2829	Micro Needle Holders 15 cm / 5 7/8" Ti with ratchet Ø 0.80 mm
2712	HMI-SI-2830	Micro Needle Holders 15 cm / 5 7/8" Ti with ratchet Ø 0.80 mm
2713	HMI-SI-2831	Micro Needle Holders 15 cm / 5 7/8" Ti w/o ratchet Ø 0.80 mm
2714	HMI-SI-2832	Micro Needle Holders 15 cm / 5 7/8" Ti w/o ratchet Ø 0.80 mm
2715	HMI-SI-2833	Micro Needle Holders 18 cm / 7 1/8" St with ratchet Ø 0.80 mm
2716	HMI-SI-2834	Micro Needle Holders 18 cm / 7 1/8" St with ratchet Ø 0.80 mm
2717	HMI-SI-2835	Micro Needle Holders 18 cm / 7 1/8" St w/o ratchet Ø 0.80 mm
2718	HMI-SI-2836	Micro Needle Holders 18 cm / 7 1/8" St w/o ratchet Ø 0.80 mm
2719	HMI-SI-2837	Micro Needle Holders 18 cm / 7 1/8" Ti with ratchet Ø 0.80 mm

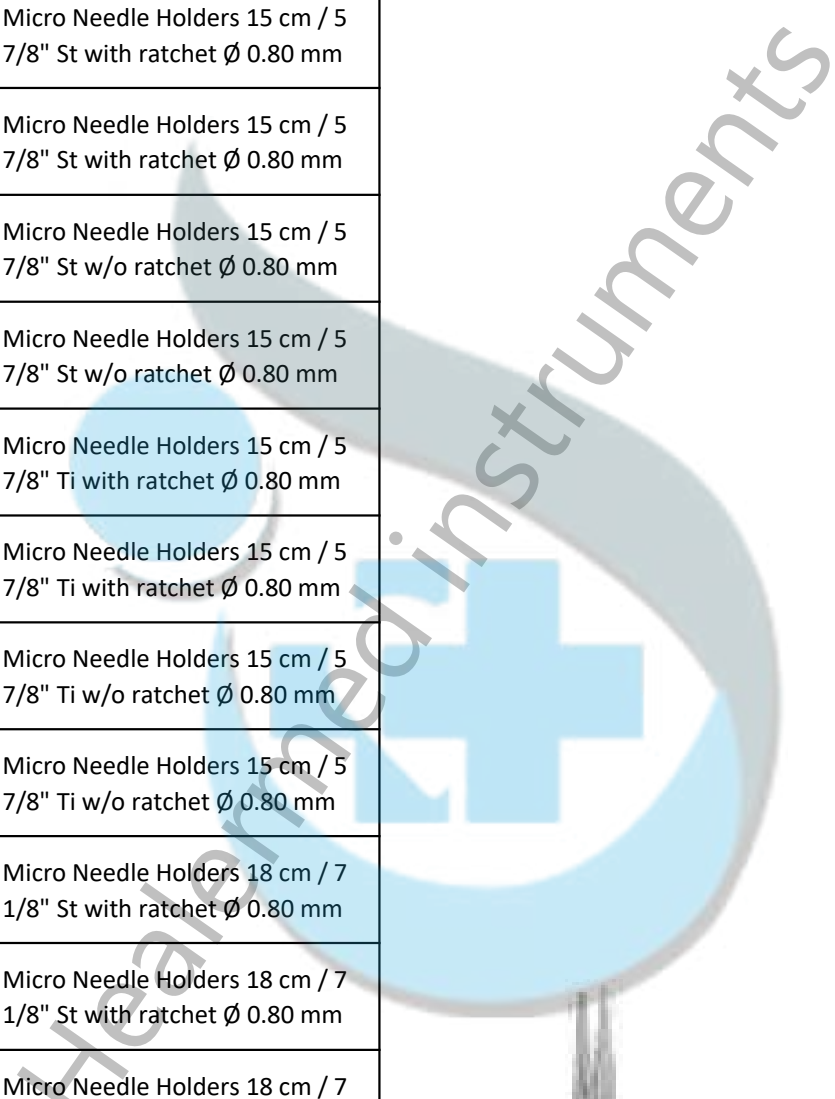
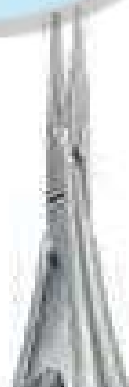

2720	HMI-SI-2838	Micro Needle Holders 18 cm / 7 1/8" Ti with ratchet Ø 0.80 mm
2721	HMI-SI-2839	Micro Needle Holders 18 cm / 7 1/8" Ti w/o ratchet Ø 0.80 mm
2722	HMI-SI-2840	Micro Needle Holders 18 cm / 7 1/8" Ti w/o ratchet Ø 0.80 mm
2723	HMI-SI-2841	Micro Needle Holders 21 cm / 8 2/8" St with ratchet Ø 0.80 mm
2724	HMI-SI-2842	Micro Needle Holders 21 cm / 8 2/8" St with ratchet Ø 0.80 mm
2725	HMI-SI-2843	Micro Needle Holders 21 cm / 8 2/8" St w/o ratchet Ø 0.80 mm
2726	HMI-SI-2844	Micro Needle Holders 21 cm / 8 2/8" St w/o ratchet Ø 0.80 mm
2727	HMI-SI-2845	Micro Needle Holders 21 cm / 8 2/8" Ti with ratchet Ø 0.80 mm
2728	HMI-SI-2846	Micro Needle Holders 21 cm / 8 2/8" Ti with ratchet Ø 0.80 mm
2729	HMI-SI-2847	Micro Needle Holders 21 cm / 8 2/8" Ti w/o ratchet Ø 0.80 mm
2730	HMI-SI-2848	Micro Needle Holders 21 cm / 8 2/8" Ti w/o ratchet Ø 0.80 mm
2731	HMI-SI-2849	Micro Needle Holders 23 cm / 9" St with ratchet Ø 0.80 mm
2732	HMI-SI-2850	Micro Needle Holders 23 cm / 9" St with ratchet Ø 0.80 mm
2733	HMI-SI-2851	Micro Needle Holders 23 cm / 9" St w/o ratchet Ø 0.80 mm
2734	HMI-SI-2852	Micro Needle Holders 23 cm / 9" St w/o ratchet Ø 0.80 mm
2735	HMI-SI-2853	Micro Needle Holders 23 cm / 9" Ti with ratchet Ø 0.80 mm
2736	HMI-SI-2854	Micro Needle Holders 23 cm / 9" Ti with ratchet Ø 0.80 mm
2737	HMI-SI-2855	Micro Needle Holders 23 cm / 9" Ti w/o ratchet Ø 0.80 mm
2738	HMI-SI-2856	Micro Needle Holders 23 cm / 9" Ti w/o ratchet Ø 0.80 mm



2739	HMI-SI-2857	Micro Needle Holders 25 cm / 9 7/8" St with ratchet Ø 0.80 mm
2740	HMI-SI-2858	Micro Needle Holders 25 cm / 9 7/8" St with ratchet Ø 0.80 mm
2741	HMI-SI-2859	Micro Needle Holders 25 cm / 9 7/8" St w/o ratchet Ø 0.80 mm
2742	HMI-SI-2860	Micro Needle Holders 25 cm / 9 7/8" St w/o ratchet Ø 0.80 mm
2743	HMI-SI-2861	Micro Needle Holders 25 cm / 9 7/8" Ti with ratchet Ø 0.80 mm
2744	HMI-SI-2862	Micro Needle Holders 25 cm / 9 7/8" Ti with ratchet Ø 0.80 mm
2745	HMI-SI-2863	Micro Needle Holders 25 cm / 9 7/8" Ti w/o ratchet Ø 0.80 mm
2746	HMI-SI-2864	Micro Needle Holders 25 cm / 9 7/8" Ti w/o ratchet Ø 0.80 mm
2747	HMI-SI-2866	Micro Needle Holders 15 cm / 5 7/8" St with ratchet Ø 1.2 mm
2748	HMI-SI-2867	Micro Needle Holders 15 cm / 5 7/8" St with ratchet Ø 1.2 mm
2749	HMI-SI-2868	Micro Needle Holders 15 cm / 5 7/8" St w/o ratchet Ø 1.2 mm
2750	HMI-SI-2869	Micro Needle Holders 15 cm / 5 7/8" St w/o ratchet Ø 1.2 mm
2751	HMI-SI-2870	Micro Needle Holders 15 cm / 5 7/8" Ti with ratchet Ø 1.2 mm
2752	HMI-SI-2871	Micro Needle Holders 15 cm / 5 7/8" Ti with ratchet Ø 1.2 mm
2753	HMI-SI-2872	Micro Needle Holders 15 cm / 5 7/8" Ti w/o ratchet Ø 1.2 mm
2754	HMI-SI-2873	Micro Needle Holders 15 cm / 5 7/8" Ti w/o ratchet Ø 1.2 mm

2755	HMI-SI-2874	Micro Needle Holders 18 cm / 7 1/8" St with ratchet Ø 1.2 mm
2756	HMI-SI-2875	Micro Needle Holders 18 cm / 7 1/8" St with ratchet Ø 1.2 mm
2757	HMI-SI-2876	Micro Needle Holders 18 cm / 7 1/8" St w/o ratchet Ø 1.2 mm
2758	HMI-SI-2877	Micro Needle Holders 18 cm / 7 1/8" St w/o ratchet Ø 1.2 mm
2759	HMI-SI-2878	Micro Needle Holders 18 cm / 7 1/8" Ti with ratchet Ø 1.2 mm
2760	HMI-SI-2879	Micro Needle Holders 18 cm / 7 1/8" Ti with ratchet Ø 1.2 mm
2761	HMI-SI-2880	Micro Needle Holders 18 cm / 7 1/8" Ti w/o ratchet Ø 1.2 mm
2762	HMI-SI-2881	Micro Needle Holders 18 cm / 7 1/8" Ti w/o ratchet Ø 1.2 mm
2763	HMI-SI-2882	Micro Needle Holders 21 cm / 8 2/8" St with ratchet Ø 1.2 mm
2764	HMI-SI-2883	Micro Needle Holders 21 cm / 8 2/8" St with ratchet Ø 1.2 mm
2765	HMI-SI-2884	Micro Needle Holders 21 cm / 8 2/8" St w/o ratchet Ø 1.2 mm
2766	HMI-SI-2885	Micro Needle Holders 21 cm / 8 2/8" St w/o ratchet Ø 1.2 mm
2767	HMI-SI-2886	Micro Needle Holders 21 cm / 8 2/8" Ti with ratchet Ø 1.2 mm
2768	HMI-SI-2887	Micro Needle Holders 21 cm / 8 2/8" Ti with ratchet Ø 1.2 mm
2769	HMI-SI-2888	Micro Needle Holders 21 cm / 8 2/8" Ti w/o ratchet Ø 1.2 mm
2770	HMI-SI-2889	Micro Needle Holders 21 cm / 8 2/8" Ti w/o ratchet Ø 1.2 mm
2771	HMI-SI-2890	Micro Needle Holders 23 cm / 9" St with ratchet Ø 1.2 mm



571

2772	HMI-SI-2891	Micro Needle Holders 23 cm / 9" St with ratchet Ø 1.2 mm
2773	HMI-SI-2892	Micro Needle Holders 23 cm / 9" St w/o ratchet Ø 1.2 mm
2774	HMI-SI-2893	Micro Needle Holders 23 cm / 9" St w/o ratchet Ø 1.2 mm
2775	HMI-SI-2894	Micro Needle Holders 23 cm / 9" Ti with ratchet Ø 1.2 mm
2776	HMI-SI-2895	Micro Needle Holders 23 cm / 9" Ti with ratchet Ø 1.2 mm
2777	HMI-SI-2896	Micro Needle Holders 23 cm / 9" Ti w/o ratchet Ø 1.2 mm
2778	HMI-SI-2897	Micro Needle Holders 23 cm / 9" Ti w/o ratchet Ø 1.2 mm
2779	HMI-SI-2898	Micro Needle Holders 25 cm / 9 7/8" St with ratchet Ø 1.2 mm
2780	HMI-SI-2899	Micro Needle Holders 25 cm / 9 7/8" St with ratchet Ø 1.2 mm
2781	HMI-SI-2900	Micro Needle Holders 25 cm / 9 7/8" St w/o ratchet Ø 1.2 mm
2782	HMI-SI-2901	Micro Needle Holders 25 cm / 9 7/8" St w/o ratchet Ø 1.2 mm
2783	HMI-SI-2902	Micro Needle Holders 25 cm / 9 7/8" Ti with ratchet Ø 1.2 mm
2784	HMI-SI-2903	Micro Needle Holders 25 cm / 9 7/8" Ti with ratchet Ø 1.2 mm
2785	HMI-SI-2904	Micro Needle Holders 25 cm / 9 7/8" Ti w/o ratchet Ø 1.2 mm
2786	HMI-SI-2905	Micro Needle Holders 25 cm / 9 7/8" Ti w/o ratchet Ø 1.2 mm
2787	HMI-SI-2907	Micro Needle Holders 15 cm / 5 7/8" St with ratchet Ø 0.80 mm
2788	HMI-SI-2908	Micro Needle Holders 15 cm / 5 7/8" St with ratchet Ø 0.80 mm
2789	HMI-SI-2909	Micro Needle Holders 15 cm / 5 7/8" St w/o ratchet Ø 0.80 mm
2790	HMI-SI-2910	Micro Needle Holders 15 cm / 5 7/8" St w/o ratchet Ø 0.80 mm

2791	HMI-SI-2911	Micro Needle Holders 15 cm / 5 7/8" Ti with ratchet Ø 0.80 mm
2792	HMI-SI-2912	Micro Needle Holders 15 cm / 5 7/8" Ti with ratchet Ø 0.80 mm
2793	HMI-SI-2913	Micro Needle Holders 15 cm / 5 7/8" Ti w/o ratchet Ø 0.80 mm
2794	HMI-SI-2914	Micro Needle Holders 15 cm / 5 7/8" Ti w/o ratchet Ø 0.80 mm
2795	HMI-SI-2915	Micro Needle Holders 18 cm / 7 1/8" St with ratchet Ø 0.80 mm
2796	HMI-SI-2916	Micro Needle Holders 18 cm / 7 1/8" St with ratchet Ø 0.80 mm
2797	HMI-SI-2917	Micro Needle Holders 18 cm / 7 1/8" St w/o ratchet Ø 0.80 mm
2798	HMI-SI-2918	Micro Needle Holders 18 cm / 7 1/8" St w/o ratchet Ø 0.80 mm
2799	HMI-SI-2919	Micro Needle Holders 18 cm / 7 1/8" Ti with ratchet Ø 0.80 mm
2800	HMI-SI-2920	Micro Needle Holders 18 cm / 7 1/8" Ti with ratchet Ø 0.80 mm
2801	HMI-SI-2921	Micro Needle Holders 18 cm / 7 1/8" Ti w/o ratchet Ø 0.80 mm
2802	HMI-SI-2922	Micro Needle Holders 18 cm / 7 1/8" Ti w/o ratchet Ø 0.80 mm
2803	HMI-SI-2923	Micro Needle Holders 21 cm / 8 2/8" St with ratchet Ø 0.80 mm
2804	HMI-SI-2924	Micro Needle Holders 21 cm / 8 2/8" St with ratchet Ø 0.80 mm
2805	HMI-SI-2925	Micro Needle Holders 21 cm / 8 2/8" St w/o ratchet Ø 0.80 mm
2806	HMI-SI-2926	Micro Needle Holders 21 cm / 8 2/8" St w/o ratchet Ø 0.80 mm





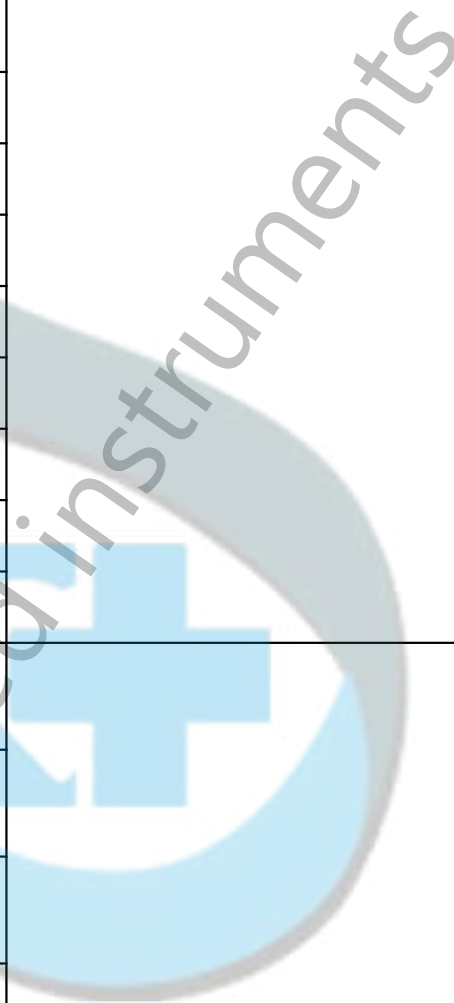





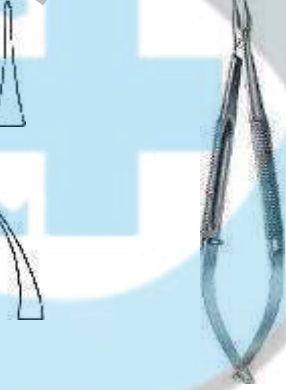



2807	HMI-SI-2927	Micro Needle Holders 21 cm / 8 2/8" Ti with ratchet Ø 0.80 mm
2808	HMI-SI-2928	Micro Needle Holders 21 cm / 8 2/8" Ti with ratchet Ø 0.80 mm
2809	HMI-SI-2929	Micro Needle Holders 21 cm / 8 2/8" Ti w/o ratchet Ø 0.80 mm
2810	HMI-SI-2930	Micro Needle Holders 21 cm / 8 2/8" Ti w/o ratchet Ø 0.80 mm
2811	HMI-SI-2931	Micro Needle Holders 23 cm / 9" St with ratchet Ø 0.80 mm
2812	HMI-SI-2932	Micro Needle Holders 23 cm / 9" St with ratchet Ø 0.80 mm
2813	HMI-SI-2933	Micro Needle Holders 23 cm / 9" St w/o ratchet Ø 0.80 mm
2814	HMI-SI-2934	Micro Needle Holders 23 cm / 9" St w/o ratchet Ø 0.80 mm
2815	HMI-SI-2935	Micro Needle Holders 23 cm / 9" Ti with ratchet Ø 0.80 mm
2816	HMI-SI-2936	Micro Needle Holders 23 cm / 9" Ti with ratchet Ø 0.80 mm
2817	HMI-SI-2937	Micro Needle Holders 23 cm / 9" Ti w/o ratchet Ø 0.80 mm
2818	HMI-SI-2938	Micro Needle Holders 23 cm / 9" Ti w/o ratchet Ø 0.80 mm
2819	HMI-SI-2939	Micro Needle Holders 15 cm / 5 7/8" St with ratchet Ø 1.2 mm
2820	HMI-SI-2940	Micro Needle Holders 15 cm / 5 7/8" St with ratchet Ø 1.2 mm
2821	HMI-SI-2941	Micro Needle Holders 15 cm / 5 7/8" St w/o ratchet Ø 1.2 mm
2822	HMI-SI-2942	Micro Needle Holders 15 cm / 5 7/8" St w/o ratchet Ø 1.2 mm
2823	HMI-SI-2943	Micro Needle Holders 15 cm / 5 7/8" Ti with ratchet Ø 1.2 mm
2824	HMI-SI-2944	Micro Needle Holders 15 cm / 5 7/8" Ti with ratchet Ø 1.2 mm
2825	HMI-SI-2945	Micro Needle Holders 15 cm / 5 7/8" Ti w/o ratchet Ø 1.2 mm











2826	HMI-SI-2946	Micro Needle Holders 15 cm / 5 7/8" Ti w/o ratchet Ø 1.2 mm
2827	HMI-SI-2947	Micro Needle Holders 18 cm / 7 1/8" St with ratchet Ø 1.2 mm
2828	HMI-SI-2948	Micro Needle Holders 18 cm / 7 1/8" St with ratchet Ø 1.2 mm
2829	HMI-SI-2949	Micro Needle Holders 18 cm / 7 1/8" St w/o ratchet Ø 1.2 mm
2830	HMI-SI-2950	Micro Needle Holders 18 cm / 7 1/8" St w/o ratchet Ø 1.2 mm
2831	HMI-SI-2951	Micro Needle Holders 18 cm / 7 1/8" Ti with ratchet Ø 1.2 mm
2832	HMI-SI-2952	Micro Needle Holders 18 cm / 7 1/8" Ti with ratchet Ø 1.2 mm
2833	HMI-SI-2953	Micro Needle Holders 18 cm / 7 1/8" Ti w/o ratchet Ø 1.2 mm
2834	HMI-SI-2954	Micro Needle Holders 18 cm / 7 1/8" Ti w/o ratchet Ø 1.2 mm
2835	HMI-SI-2955	Micro Needle Holders 21 cm / 8 2/8" St with ratchet Ø 1.2 mm
2836	HMI-SI-2956	Micro Needle Holders 21 cm / 8 2/8" St with ratchet Ø 1.2 mm
2837	HMI-SI-2957	Micro Needle Holders 21 cm / 8 2/8" St w/o ratchet Ø 1.2 mm
2838	HMI-SI-2958	Micro Needle Holders 21 cm / 8 2/8" St w/o ratchet Ø 1.2 mm
2839	HMI-SI-2959	Micro Needle Holders 21 cm / 8 2/8" Ti with ratchet Ø 1.2 mm
2840	HMI-SI-2960	Micro Needle Holders 21 cm / 8 2/8" Ti with ratchet Ø 1.2 mm
2841	HMI-SI-2961	Micro Needle Holders 21 cm / 8 2/8" Ti w/o ratchet Ø 1.2 mm















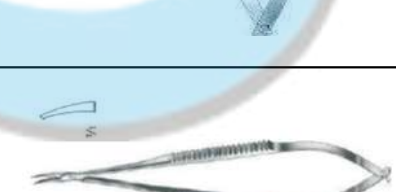

2842	HMI-SI-2962	Micro Needle Holders 21 cm / 8 2/8" Ti w/o ratchet Ø 1.2 mm	
2843	HMI-SI-2963	Micro Needle Holders 23 cm / 9" St with ratchet Ø 1.2 mm	
2844	HMI-SI-2964	Micro Needle Holders 23 cm / 9" St with ratchet Ø 1.2 mm	
2845	HMI-SI-2965	Micro Needle Holders 23 cm / 9" St w/o ratchet Ø 1.2 mm	
2846	HMI-SI-2966	Micro Needle Holders 23 cm / 9" St w/o ratchet Ø 1.2 mm	
2847	HMI-SI-2967	Micro Needle Holders 23 cm / 9" Ti with ratchet Ø 1.2 mm	
2848	HMI-SI-2968	Micro Needle Holders 23 cm / 9" Ti with ratchet Ø 1.2 mm	
2849	HMI-SI-2969	Micro Needle Holders 23 cm / 9" Ti w/o ratchet Ø 1.2 mm	
2850	HMI-SI-2970	Micro Needle Holders 23 cm / 9" Ti w/o ratchet Ø 1.2 mm	
2851	HMI-SI-2971	Micro Needle Holders Kalt 13,5 cm / 5 1/8"	
2852	HMI-SI-2972	Micro Needle Holders Barraquer-Troutman 10,5 cm / 4 1/8"	
2853	HMI-SI-2973	Micro Needle Holders Barraquer-Troutman 10,5 cm / 4 1/8"	
2854	HMI-SI-2974	Micro Needle Holders Arruga 13,5 cm / 5 3/8"	
2855	HMI-SI-2975	Micro Needle Holders Arruga 13,5 cm / 5 3/8"	





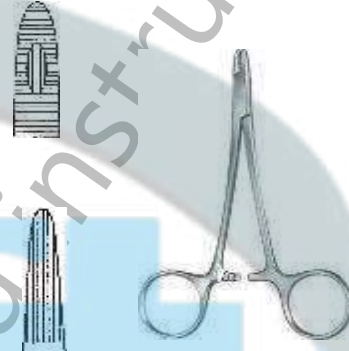

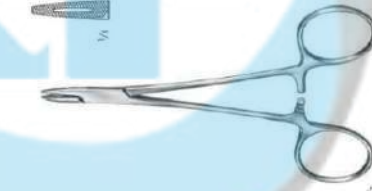
2856	HMI-SI-2976	Micro Needle Holders Barraquer-Troutman 10,5 cm / 4 1/8"	
2857	HMI-SI-2977	Micro Needle Holders Barraquer-Troutman 10,5 cm / 4 1/8"	
2858	HMI-SI-2978	Micro Needle Holders Barraquer-Troutman 11,5 cm / 4 4/8"	
2859	HMI-SI-2979	Micro Needle Holders Barraquer-Troutman 11,5 cm / 4 4/8"	
2860	HMI-SI-2980	Micro Needle Holders Barraquer 11,5 cm / 4 4/8" w/o ratchet St	
2861	HMI-SI-2981	Micro Needle Holders Barraquer 11,5 cm / 4 4/8" w/o ratchet Ti	
2862	HMI-SI-2982	Micro Needle Holders Barraquer 13,5 cm / 5 3/8" w/o ratchet St	
2863	HMI-SI-2983	Micro Needle Holders Barraquer 13,5 cm / 5 3/8" with ratchet Ti	







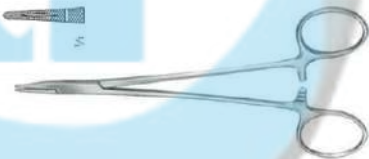





2864	HMI-SI-2984	Micro Needle Holders Barraquer 13,5 cm / 5 3/8" very delicate jaw	 A pair of Barraquer micro needle holders with long, thin jaws and a curved handle. A small inset shows the tip of the jaws. The handle has a locking mechanism. Labels 1/8 and 1/2 are present.
2865	HMI-SI-2985	Micro Needle Holders Castroviejo-Fino 13 cm / 5 1/8" very delicate jaw	 A pair of Castroviejo-Fino micro needle holders with long, thin jaws and a curved handle. A small inset shows the tip of the jaws. The handle has a locking mechanism. Labels 1/8 and 1/2 are present.
2866	HMI-SI-2986	Micro Needle Holders Castroviejo-Fino 13 cm / 5 1/8" very delicate jaw	 A pair of Castroviejo-Fino micro needle holders with long, thin jaws and a curved handle. A small inset shows the tip of the jaws. The handle has a locking mechanism. Labels 1/8 and 1/2 are present.
2867	HMI-SI-2987	Micro Needle Holders Castroviejo-Fino 13 cm / 5 1/8" very delicate jaw, with lock	 A pair of Castroviejo-Fino micro needle holders with long, thin jaws and a curved handle. A small inset shows the tip of the jaws. The handle has a locking mechanism. Labels 1/8 and 1/2 are present.
2868	HMI-SI-2988	Micro Needle Holders Castroviejo-Fino 13 cm / 5 1/8" very delicate jaw, with lock	 A pair of Castroviejo-Fino micro needle holders with long, thin jaws and a curved handle. A small inset shows the tip of the jaws. The handle has a locking mechanism. Labels 1/8 and 1/2 are present.
2869	HMI-SI-2989	Micro Needle Holders Castroviejo-Fino 9 cm / 3 4/8"	 A pair of Castroviejo-Fino micro needle holders with long, thin jaws and a curved handle. A small inset shows the tip of the jaws. The handle has a locking mechanism. Labels 1/8 and 1/2 are present.
2870	HMI-SI-2990	Micro Needle Holders Castroviejo-Fino 9 cm / 3 4/8"	 A pair of Castroviejo-Fino micro needle holders with long, thin jaws and a curved handle. A small inset shows the tip of the jaws. The handle has a locking mechanism. Labels 1/8 and 1/2 are present.
2871	HMI-SI-2991	Micro Needle Holders Castroviejo-Fino 9 cm / 3 4/8"	 A pair of Castroviejo-Fino micro needle holders with long, thin jaws and a curved handle. A small inset shows the tip of the jaws. The handle has a locking mechanism. Labels 1/8 and 1/2 are present.



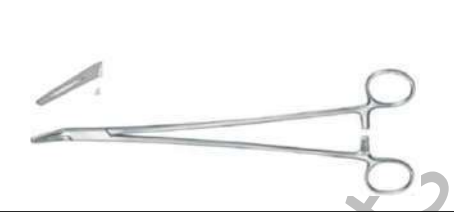
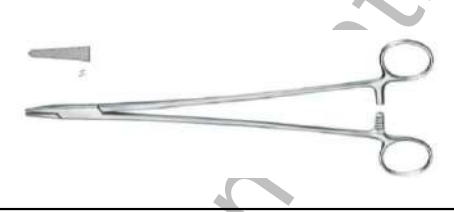

2872	HMI-SI-2992	Micro Needle Holders Castroviejo 14,5 cm / 5 6/8"	
2873	HMI-SI-2993	Micro Needle Holders Castroviejo 14,5 cm / 5 6/8"	
2874	HMI-SI-2994	Micro Needle Holders Castroviejo 14,5 cm / 5 6/8"	
2875	HMI-SI-2995	Micro Needle Holders Castroviejo 14,5 cm / 5 6/8"	
2876	HMI-SI-2996	Micro Needle Holders, Needle Holders Castroviejo 14,5 cm / 5 6/8"	
2877	HMI-SI-2997	Micro Needle Holders, Needle Holders Castroviejo 14,5 cm / 5 6/8"	
2878	HMI-SI-2998	Micro Needle Holders, Needle Holders Castroviejo 14,5 cm / 5 6/8"	
2879	HMI-SI-2999	Micro Needle Holders, Needle Holders Arruga 16 cm / 6 2/8"	

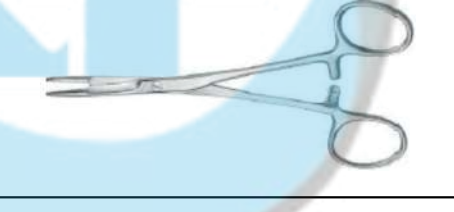

2880	HMI-SI-3000	Micro Needle Holders, Needle Holders Arruga 16 cm / 6 2/8"	
2881	HMI-SI-3001	Micro Needle Holders, Needle Holders Castroviejo 12 cm / 4 6/8"	
2882	HMI-SI-3002	Micro Needle Holders, Needle Holders Castroviejo 12 cm / 4 6/8"	
2883	HMI-SI-3003	Needle Holders Derf 12 cm / 4 6/8" both jaws fenestrated	
2884	HMI-SI-3004	Needle Holders Derf 13 cm / 5 1/8" jaw with longitudinal serration	
2885	HMI-SI-3005	Needle Holders Collier 12,5 cm / 4 7/8" both jaws totally fenestrated	
2886	HMI-SI-3006	Needle Holders Webster 13 cm / 5 1/8" smooth jaw	
2887	HMI-SI-3007	Needle Holders Halsey 13,5 cm / 5 3/8" smooth jaw	

2888	HMI-SI-3008	Needle Holders Neivert 12,5 cm / 4 7/8" smooth jaw, special groove	
2889	HMI-SI-3009	Needle Holders Hegar-Baumgartner 14,5 cm / 5 6/8	
2890	HMI-SI-3010	Needle Holders Brown heavy pattern 13 cm / 5 1/8" diagonally serrated jaw	
2891	HMI-SI-3011	Needle Holders Brown heavy pattern 18 cm / 7 1/8" diagonally serrated jaw	
2892	HMI-SI-3012	Needle Holders Crile-Murray 15 cm / 5 7/8" slender pattern	
2893	HMI-SI-3013	Needle Holders Crile-Wood 15 cm / 5 7/8"	
2894	HMI-SI-3014	Needle Holders Adson 18,5 cm / 7 2/8" both jaws fenestrated throughout	
2895	HMI-SI-3015	Needle Holders Metzenbaum 18,5 cm / 7 2/8" one grooved and fenestrated jaw	

2896	HMI-SI-3016	Needle Holders M. G. Hospital heavy pattern 18 cm / 7 1/8"	
2897	HMI-SI-3017	Needle Holders Mayo-Hegar 14,5 cm / 5 6/8"	
2898	HMI-SI-3018	Needle Holders Mayo-Hegar 16 cm / 6 2/8"	
2899	HMI-SI-3019	Needle Holders Mayo-Hegar 18,5 cm / 7 2/8"	
2900	HMI-SI-3020	Needle Holders Mayo-Hegar 20,5 cm / 8 1/8"	
2901	HMI-SI-3021	Needle Holders Mayo-Hegar 24 cm / 9 4/8"	
2902	HMI-SI-3022	Needle Holders Mayo-Hegar 26,5 cm / 10 3/8"	
2903	HMI-SI-3023	Needle Holders Mayo-Hegar 30,5 cm / 12 "	
2904	HMI-SI-3024	Needle Holders Mayo-Hegar slender pattern 16 cm / 6 2/8"	
2905	HMI-SI-3025	Needle Holders Mayo-Hegar slender pattern 19 cm / 7 4/8"	
2906	HMI-SI-3026	Needle Holders Mayo-Hegar slender pattern 20,5 cm / 8 1/8"	
2907	HMI-SI-3027	Needle Holders Heaney 20,5 cm / 8 1/8"	
2908	HMI-SI-3028	Needle Holders Jameson 23 cm / 9 "	



2909	HMI-SI-3029	Needle Holders Masson heavy pattern 26,5 cm / 10 3/8"	
2910	HMI-SI-3030	Needle Holders Finochietto 26,5 cm / 10 3/8"	
2911	HMI-SI-3031	Needle Holders Wangensteen 26,5 cm / 10 3/8"	
2912	HMI-SI-3032	Needle Holders Johnson 27 cm / 10 5/8"	
2913	HMI-SI-3033	Needle Holders Stratte 23 cm / 9"	
2914	HMI-SI-3034	Needle Holders Olsen-Hegar 14 cm / 5 4/8"	
2915	HMI-SI-3035	Needle Holders Gillies 16 cm / 6 2/8"	
2916	HMI-SI-3036	Needle Holders Crile 15 cm / 5 7/8"	

2917	HMI-SI-3037	Needle Holders Mathieu 14 cm / 5 4/8"	
2918	HMI-SI-3038	Needle Holders Mathieu 17 cm / 6 6/8"	
2919	HMI-SI-3039	Needle Holders Mathieu 20 cm / 7 7/8"	
2920	HMI-SI-3041	Micro Needle Holders, Needle Holders Mathieu slender pattern 14 cm / 5 4/8"	
2921	HMI-SI-3042	Micro Needle Holders, Needle Holders Mathieu slender pattern 17 cm / 6 6/8"	
2922	HMI-SI-3043	Micro Needle Holders, Needle Holders Toennis 18,5 cm / 7 2/8"	
2923	HMI-SI-3044	Micro Needle Holders, Needle Holders Lichtenberg 20 cm / 7 7/8"	
2924	HMI-SI-3045	Micro Needle Holders, Needle Holders smooth jaw 16 cm / 6 2/8"	

2925	HMI-SI-3046	Micro Needle Holders, Needle Holders smooth jaw 23 cm / 9 "	
2926	HMI-SI-3047	Micro Needle Holders, Needle Holders smooth jaw 23 cm / 9 "	
2927	HMI-SI-3048	Micro Needle Holders, Needle Holders smooth jaw 19 cm / 7 4/8"	
2928	HMI-SI-3049	Micro Needle Holders, Needle Holders TCGOLD Hepp-Scheidel 18,5 cm / 7 2/8"	
2929	HMI-SI-3050	Micro Needle Holders, Needle Holders TCGOLD Webster 13 cm / 5 1/8" with automatic release ratchet also for lefthanders	
2930	HMI-SI-3051	Micro Needle Holders, Needle Holders TCGOLD Crile-Wood 15 cm / 5 7/8" with automatic release ratchet also for lefthanders	
2931	HMI-SI-3052	Micro Needle Holders, Needle Holders St with ratchet 15 cm / 5 7/8"	
2932	HMI-SI-3053	Micro Needle Holders, Needle Holders St with ratchet 15 cm / 5 7/8"	
2933	HMI-SI-3054	Micro Needle Holders, Needle Holders St w/o ratchet 15 cm / 5 7/8"	
2934	HMI-SI-3055	Micro Needle Holders, Needle Holders St w/o ratchet 15 cm / 5 7/8"	





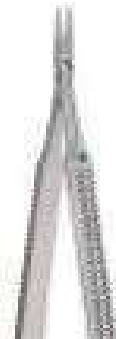

2935	HMI-SI-3056	Micro Needle Holders, Needle Holders St with ratchet 18 cm / 7 1/8"
2936	HMI-SI-3057	Micro Needle Holders, Needle Holders St with ratchet 18 cm / 7 1/8"
2937	HMI-SI-3058	Micro Needle Holders, Needle Holders St w/o ratchet 18 cm / 7 1/8"
2938	HMI-SI-3059	Micro Needle Holders, Needle Holders St w/o ratchet 18 cm / 7 1/8"
2939	HMI-SI-3060	Micro Needle Holders, Needle Holders St with ratchet 21 cm / 8 2/8"
2940	HMI-SI-3061	Micro Needle Holders, Needle Holders St with ratchet 21 cm / 8 2/8"
2941	HMI-SI-3062	Micro Needle Holders, Needle Holders St w/o ratchet 21 cm / 8 2/8"
2942	HMI-SI-3063	Micro Needle Holders, Needle Holders St w/o ratchet 21 cm / 8 2/8"
2943	HMI-SI-3064	Micro Needle Holders, Needle Holders St with ratchet 23 cm / 9"
2944	HMI-SI-3065	Micro Needle Holders, Needle Holders St with ratchet 23 cm / 9"
2945	HMI-SI-3066	Micro Needle Holders, Needle Holders St w/o ratchet 23 cm / 9"
2946	HMI-SI-3067	Micro Needle Holders, Needle Holders St w/o ratchet 23 cm / 9"
2947	HMI-SI-3068	Micro Needle Holders, Needle Holders St with ratchet 25 cm / 9 7/8"
2948	HMI-SI-3069	Micro Needle Holders, Needle Holders St with ratchet 25 cm / 9 7/8"
2949	HMI-SI-3070	Micro Needle Holders, Needle Holders St w/o ratchet 25 cm / 9 7/8"
2950	HMI-SI-3071	Micro Needle Holders, Needle Holders St w/o ratchet 25 cm / 9 7/8"











2951	HMI-SI-3072	Micro Needle Holders, Needle Holders TCGOLD Jaboma 18 cm / 7 1/8"	
2952	HMI-SI-3073	Needle Holders Gregory double-action 18 cm / 7 2/8"	
2953	HMI-SI-3074	Needle Holders Gregory double-action 21 cm / 7 2/8"	
2954	HMI-SI-3075	Needle Holders Heavy Duty 19 cm / 7 4/8"	
2955	HMI-SI-3076	Needle Holders Heavy Duty 23 cm / 9"	
2956	HMI-SI-3077	Needle Holders Heavy Duty 25 cm / 9 7/8"	
2957	HMI-SI-3079	Needle Holders 14,5 cm / 5 6/8" St with ratchet Ø 0.40 mm	
2958	HMI-SI-3080	Needle Holders 14,5 cm / 5 6/8" St with ratchet Ø 0.40 mm	



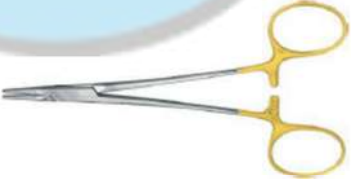

2959	HMI-SI-3081	Needle Holders 14,5 cm / 5 6/8" St w/o ratchet Ø 0.40 mm
2960	HMI-SI-3082	Needle Holders 14,5 cm / 5 6/8" St w/o ratchet Ø 0.40 mm
2961	HMI-SI-3083	Needle Holders 14,5 cm / 5 6/8" St with ratchet Ø 0.40 mm
2962	HMI-SI-3084	Needle Holders 14,5 cm / 5 6/8" St with ratchet Ø 0.40 mm
2963	HMI-SI-3085	Needle Holders 14,5 cm / 5 6/8" St w/o ratchet Ø 0.40 mm
2964	HMI-SI-3086	Needle Holders 14,5 cm / 5 6/8" St w/o ratchet Ø 0.40 mm
2965	HMI-SI-3087	Needle Holders TCGOLD Castroviejo 14,5 cm / 5 6/8" Micro
2966	HMI-SI-3088	Needle Holders TCGOLD Castroviejo 14,5 cm / 5 6/8" Micro
2967	HMI-SI-3089	Needle Holders TCGOLD Castroviejo 14,5 cm / 5 6/8" Smooth
2968	HMI-SI-3090	Needle Holders TCGOLD Castroviejo 18 cm / 7 1/8" Micro









2969	HMI-SI-3091	Needle Holders TCGOLD Castroviejo 22 cm / 8 5/8" Micro	
2970	HMI-SI-3092	Needle Holders TCGOLD Castroviejo 14,5 cm / 5 6/8" Smooth	
2971	HMI-SI-3093	Needle Holders TCGOLD Castroviejo 18 cm / 7 1/8" Micro	
2972	HMI-SI-3094	Needle Holders TCGOLD Castroviejo 22 cm / 8 5/8" Micro	
2973	HMI-SI-3095	Needle Holders TCGOLD Arruga 16 cm / 6 2/8" Mini	
2974	HMI-SI-3096	Needle Holders TCGOLD Arruga 16 cm / 6 2/8" Mini	
2975	HMI-SI-3097	Needle Holders TCGOLD Castroviejo 12,5 cm / 4 7/8" with lock smooth	
2976	HMI-SI-3098	Needle Holders TCGOLD Barraquer 13 cm / 5 1/8" with lock smooth	
2977	HMI-SI-3099	Needle Holders TCGOLD Barraquer 13 cm / 5 1/8" w/o ratchet smooth	
2978	HMI-SI-3100	Needle Holders TCGOLD Webster 13 cm / 5 1/8" smooth	





2979	HMI-SI-3101	Needle Holders TCGOLD Kilner 14,5 cm / 5 6/8" Mini	
2980	HMI-SI-3102	Needle Holders TCGOLD Derf 12 cm / 4 6/8" Mini	
2981	HMI-SI-3103	Needle Holders TCGOLD Hegar- Baumgartner 13 cm / 5 1/8" mini	
2982	HMI-SI-3104	Needle Holders TCGOLD Hegar- Baumgartner 14,5 cm / 5 6/8" mini	
2983	HMI-SI-3105	Needle Holders TCGOLD Halsey 13 cm / 5 1/8" Smooth	
2984	HMI-SI-3106	Needle Holders TCGOLD Halsey 13 cm / 5 1/8" Mini	
2985	HMI-SI-3107	Needle Holders TCGOLD Webster 12 cm / 4 6/8" Smooth	
2986	HMI-SI-3108	Needle Holders TCGOLD Crile- Wood 15 cm / 5 7/8" Mini	







2987	HMI-SI-3109	Needle Holders TCGOLD Crile-Wood 20,5 cm / 8 1/8" Mini	
2988	HMI-SI-3110	Needle Holders TCGOLD Sarot 18 cm / 7 1/8"	
2989	HMI-SI-3111	Needle Holders TCGOLD Sarot 20 cm / 7 7/8"	
2990	HMI-SI-3112	Needle Holders TCGOLD Sarot 26 cm / 10 2/8"	
2991	HMI-SI-3113	Needle Holders TCGOLD Mayo-Hegar 16 cm / 6 2/8"	
2992	HMI-SI-3114	Needle Holders TCGOLD Mayo-Hegar 18,5 cm / 7 2/8"	
2993	HMI-SI-3115	Needle Holders TCGOLD Mayo-Hegar 20 cm / 7 7/8"	
2994	HMI-SI-3116	Needle Holders TCGOLD Mayo-Hegar 24 cm / 9 4/8"	
2995	HMI-SI-3117	Needle Holders TCGOLD Mayo-Hegar 26,5 cm / 10 3/8"	
2996	HMI-SI-3118	Needle Holders TCGOLD Mayo-Hegar 30 cm / 11 6/8"	
2997	HMI-SI-3119	Needle Holders TCGOLD Heaney 20,5 cm / 8 1/8"	
2998	HMI-SI-3120	Needle Holders TCGOLD Heaney 24 cm / 9 4/8"	



2999	HMI-SI-3121	Needle Holders TCGOLD Heaney 26,5 cm / 10 3/8"		
3000	HMI-SI-3122	Needle Holders TCGOLD DeBakey 18 cm / 7 1/8"		
3001	HMI-SI-3123	Needle Holders TCGOLD DeBakey 20,5 cm / 8 1/8"		
3002	HMI-SI-3124	Needle Holders TCGOLD DeBakey 23 cm / 9"		
3003	HMI-SI-3125	Needle Holders TCGOLD DeBakey 26,5 cm / 10 3/8"		
3004	HMI-SI-3126	Needle Holders TCGOLD DeBakey 31 cm / 12 2/8"		
3005	HMI-SI-3127	Needle Holders TCGOLD Masson 26,5 cm / 10 3/8"		
3006	HMI-SI-3128	Needle Holders TCGOLD Ryder (Martin) 12,5 cm / 4 7/8"		
3007	HMI-SI-3129	Needle Holders TCGOLD Ryder (Martin) 15 cm / 5 7/8"		
3008	HMI-SI-3130	Needle Holders TCGOLD Ryder (Martin) 18 cm / 7 1/8"		







3009	HMI-SI-3131	Needle Holders TCGOLD Ryder (Martin) 20 cm / 7 7/8"	
3010	HMI-SI-3132	Needle Holders TCGOLD Ryder (Martin) 23 cm / 9"	
3011	HMI-SI-3133	Needle Holders TCGOLD Ryder (Martin) 26 cm / 10 2/8"	
3012	HMI-SI-3134	Needle Holders TCGOLD Martin elastic tip 15 cm / 5 7/8"	
3013	HMI-SI-3135	Needle Holders TCGOLD Martin elastic tip 17 cm / 6 6/8"	
3014	HMI-SI-3136	Needle Holders TCGOLD Martin elastic tip 20,5 cm / 8 1/8"	
3015	HMI-SI-3137	Needle Holders TCGOLD Finochietto 26,5 cm / 10 3/8" standard proyle	
3016	HMI-SI-3138	Needle Holders TCGOLD Ryder-Vascular delicate pattern 12 cm / 4 6/8"	
3017	HMI-SI-3139	Needle Holders TCGOLD Ryder-Vascular delicate pattern 15,5 cm / 6 1/8"	
3018	HMI-SI-3140	Needle Holders TCGOLD Ryder-Vascular delicate pattern 17,5 cm / 6 7/8"	
3019	HMI-SI-3141	Needle Holders TCGOLD Ryder-Vascular delicate pattern 20 cm / 7 7/8"	
3020	HMI-SI-3142	Needle Holders TCGOLD Ryder-Vascular delicate pattern 22,5 cm / 8 7/8"	
3021	HMI-SI-3143	Needle Holders TCGOLD Ryder-Vascular delicate pattern 26 cm / 10 2/8"	





3022	HMI-SI-3144	Needle Holders TCGOLD Wangensteen 27 cm / 10 5/8"	
3023	HMI-SI-3145	Needle Holders TCGOLD Hegar-Vascular 14 cm / 5 4/8"	
3024	HMI-SI-3146	Needle Holders TCGOLD Hegar-Vascular 18,5 cm / 7 2/8"	
3025	HMI-SI-3147	Needle Holders TCGOLD Hegar-Vascular 20,5 cm / 8 1/8"	
3026	HMI-SI-3148	Needle Holders TCGOLD Hegar-Vascular 23 cm / 9"	
3027	HMI-SI-3149	Needle Holders TCGOLD Bozemann 20,5 cm / 8 1/8"	
3028	HMI-SI-3150	Needle Holders TCGOLD Bozemann 24 cm / 9 4/8"	
3029	HMI-SI-3151	Needle Holders TCGOLD Bozemann 26 cm / 10 4/8"	
3030	HMI-SI-3152	Needle Holders TCGOLD Bozemann 30 cm / 11 6/8"	
3031	HMI-SI-3153	Needle Holders TCGOLD Hegar 20 cm / 7 7/8"	



3032	HMI-SI-3154	Needle Holders TCGOLD Hegar 24 cm / 9 4/8"	
3033	HMI-SI-3155	Needle Holders TCGOLD Stratte 23 cm / 9" Standard	
3034	HMI-SI-3156	Needle Holders TCGOLD Stratte 23 cm / 9" Standard	
3035	HMI-SI-3157	Needle Holders TCGOLD Microvascular 14 cm / 5 4/8"	
3036	HMI-SI-3158	Needle Holders TCGOLD Microvascular 17,5 cm / 6 7/8"	
3037	HMI-SI-3159	Needle Holders TCGOLD Microvascular 20 cm / 7 7/8"	
3038	HMI-SI-3160	Needle Holders TCGOLD Microvascular 23 cm / 9"	
3039	HMI-SI-3161	Needle Holders TCGOLD Microvascular 26 cm / 10 2/8"	
3040	HMI-SI-3162	Needle Holders TCGOLD Martini 14 cm / 5 4/8"	
3041	HMI-SI-3163	Needle Holders TCGOLD Martini 15 cm / 5 7/8"	
3042	HMI-SI-3164	Needle Holders TCGOLD Martini 17,5 cm / 6 7/8"	
3043	HMI-SI-3165	Needle Holders TCGOLD Martini 20 cm / 7 7/8"	
3044	HMI-SI-3166	Needle Holders TCGOLD Martini delicate pattern 14 cm / 5 4/8"	
3045	HMI-SI-3167	Needle Holders TCGOLD Martini delicate pattern 15 cm / 5 7/8"	









3046	HMI-SI-3168	Needle Holders TCGOLD Martini delicate pattern 17,5 cm / 6 7/8"	
3047	HMI-SI-3169	Needle Holders TCGOLD Martini delicate pattern 20 cm / 7 7/8"	
3048	HMI-SI-3170	Needle Holders TCGOLD Olsen Hegar standard proyle 14,5 cm / 5 4/8"	
3049	HMI-SI-3171	Needle Holders TCGOLD Olsen Hegar standard proyle 17 cm / 6 6/8"	
3050	HMI-SI-3172	Needle Holders TCGOLD Olsen Hegar standard proyle 19 cm / 7 4/8"	
3051	HMI-SI-3173	Needle Holders TCGOLD Foster-Gillies 11 cm / 4 3/8"	
3052	HMI-SI-3174	Needle Holders TCGOLD Gillies-Mini 15 cm / 5 7/8"	
3053	HMI-SI-3175	Needle Holders TCGOLD Gillies 16 cm / 6 2/8"	





3054	HMI-SI-3176	Needle Holders TCGOLD Mathieu 14 cm / 5 4/8"	
3055	HMI-SI-3177	Needle Holders TCGOLD Mathieu 17 cm / 6 6/8"	
3056	HMI-SI-3178	Needle Holders TCGOLD Mathieu 20 cm / 7 7/8"	
3057	HMI-SI-3179	Needle Holders TCGOLD Mathieu 14 cm / 5 4/8"	
3058	HMI-SI-3180	Needle Holders TCGOLD Mathieu 17 cm / 6 6/8"	
3059	HMI-SI-3181	Needle Holders TCGOLD Mathieu 20 cm / 7 7/8"	
3060	HMI-SI-3182	Needle Holders TCGOLD Mathieu 17 cm / 6 6/8"	
3061	HMI-SI-3183	Needle Holders TCGOLD Mathieu 20 cm / 7 7/8"	





3062	HMI-SI-3184	Needle Holders TCGOLD Mathieu 23 cm / 9"	
3063	HMI-SI-3185	Needle Holders TCGOLD Toennis 18 cm / 7 1/8"	
3064	HMI-SI-3186	Needle Holders TCGOLD Lichtenberg 20 cm / 7 7/8"	
3065	HMI-SI-3187	Needle Holders TCGOLD Langenbeck 18,5 cm / 7 2/8"	
3066	HMI-SI-3187(a)	Needle Holders TCGOLD Langenbeck 20,5 cm / 8 1/8"	
3067	HMI-SI-3188	Needle Holders TCGOLD Langenbeck 23 cm / 9"	
3068	HMI-SI-3189	Needle Holders TCGOLD Zweifel with hinged ratchet 20 cm / 7 7/8"	
3069	HMI-SI-3190	Needle Holders TCGOLD Zweifel with hinged ratchet 23 cm / 9"	
3070	HMI-SI-3191	Reverdin Needles short 14,5 cm / 5 6/8"	









3071	HMI-SI-3192	Reverdin Needles short 14,5 cm / 5 6/8"	
3072	HMI-SI-3193	Reverdin Needles short 14,5 cm / 5 6/8"	
3073	HMI-SI-3194	Reverdin Needles short 14,5 cm / 5 6/8"	
3074	HMI-SI-3195	Reverdin Needles medium 20 cm / 7 7/8"	
3075	HMI-SI-3196	Reverdin Needles medium 20 cm / 7 7/8"	
3076	HMI-SI-3197	Reverdin Needles medium 20 cm / 7 7/8"	
3077	HMI-SI-3198	Reverdin Needles medium 20 cm / 7 7/8"	
3078	HMI-SI-3199	Reverdin Needles long 23 cm / 9"	
3079	HMI-SI-3200	Reverdin Needles long 23 cm / 9"	
3080	HMI-SI-3200(a)	Reverdin Needles long 23 cm / 9"	
3081	HMI-SI-3201	Reverdin Needles long 23 cm / 9"	
3082	HMI-SI-3202	Ligature Needles Schmieden-Dick malleable 30 cm / 11 6/8"	
3083	HMI-SI-3203	Ligature Needles Schmieden 24 cm / 9 4/8"	
3084	HMI-SI-3204	Ligature Needles malleable 20 cm / 7 7/8"	
3085	HMI-SI-3205	Ligature Needles Cooper 20 cm / 7 7/8"	





3086	HMI-SI-3206	Ligature Needles Kronecker delicate, for right hand 12 cm / 4 6/8"	
3087	HMI-SI-3207	Ligature Needles Kronecker delicate, for left hand 12 cm / 4 6/8"	
3088	HMI-SI-3208	Ligature Needles Deschamps 24 cm / 9 4/8" Hand blunt, for right hand	
3089	HMI-SI-3209	Ligature Needles Deschamps 24 cm / 9 4/8" Hand blunt, for left hand	
3090	HMI-SI-3210	Ligature Needles Deschamps 20 cm / 7 4/8" Hand blunt, for right hand	
3091	HMI-SI-3211	Ligature Needles Deschamps 20 cm / 7 4/8" Hand blunt, for left hand	
3092	HMI-SI-3212	Ligature Needles Deschamps 20 cm / 7 7/8" Hand sharp, for right hand	
3093	HMI-SI-3213	Ligature Needles Deschamps 20 cm / 7 7/8" Hand sharp, for left hand	
3094	HMI-SI-3214	Ligature Needles Deschamps 20 cm / 7 7/8" Hand blunt, for right hand	
3095	HMI-SI-3215	Ligature Needles Deschamps 20 cm / 7 7/8" Hand blunt, for left hand	
3096	HMI-SI-3216	Ligature Needles Deschamps 20 cm / 7 7/8" Hand sharp, for right hand	
3097	HMI-SI-3217	Ligature Needles Deschamps 20 cm / 7 7/8" Hand sharp, for left hand	
3098	HMI-SI-3218	Ligature Needles Deschamps 27 cm / 10 5/8" blunt, for right hand	
3099	HMI-SI-3219	Ligature Needles Deschamps 27 cm / 10 5/8" blunt, for left hand	





3100	HMI-SI-3220	Ligature Needles 27 cm / 10 5/8" Hand sharp, for right hand	
3101	HMI-SI-3221	Ligature Needles 27 cm / 10 5/8" Hand sharp, for left hand	
3102	HMI-SI-3222	Ligature Needles 28 cm / 11" Hand blunt, for right hand	
3103	HMI-SI-3223	Ligature Needles 28 cm / 11" Hand blunt, for left hand	
3104	HMI-SI-3224	Ligature Needles 21 cm / 8 2/8" Hand sharp, for right hand	
3105	HMI-SI-3225	Ligature Needles 21 cm / 8 2/8" Hand sharp, for left hand	
3106	HMI-SI-3226	Ligature Needles 21 cm / 8 2/8" Hand blunt, for right hand	
3107	HMI-SI-3227	Ligature Needles 21 cm / 8 2/8" Hand blunt, for left hand	

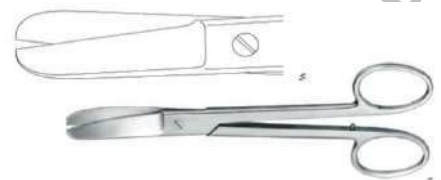
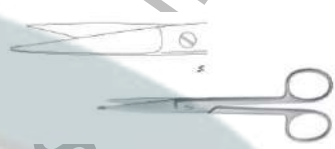







3108	HMI-SI-3228	Ligature Needles 21 cm / 8 2/8" Hand blunt, for right hand	
3109	HMI-SI-3229	Ligature Needles 21 cm / 8 2/8" Hand blunt, for left hand	
3110	HMI-SI-3230	Ligature Needles, Ligature Conductors Brunner 30 cm / 11 6/8"	
3111	HMI-SI-3231	Ligature Needles, Ligature Conductors Brunner 30 cm / 11 6/8"	
3112	HMI-SI-3232	Ligature Needles, Ligature Conductors Brunner 30 cm / 11 6/8"	
3113	HMI-SI-3233	Ligature Needles, Ligature Conductors Brunner 30 cm / 11 6/8"	
3114	HMI-SI-3234	Ligature Needles Kirschner 25,5 cm / 10"	
3115	HMI-SI-3235	Ligature Needles 28 cm / 11"	





3116	HMI-SI-3236	Ligature Needles Mod. Martin 19,5 cm / 7 5/8"	
3117	HMI-SI-3237	Ligature Conductors Schmieden 18 cm / 7 1/8"	
3118	HMI-SI-3238	Ligature Conductors Schmieden-Payr 18 cm / 7 1/8"	
3119	HMI-SI-3239	Ligature Conductors König 20 cm / 7 7/8"	
3120	HMI-SI-3240	Ligature Conductors König 20 cm / 7 7/8"	
3121	HMI-SI-3241	Ligature Conductors König 20 cm / 7 7/8"	
3122	HMI-SI-3242	Ligature Conductors Payr 22 cm / 8 5/8"	
3123	HMI-SI-3243	Ligature Conductors Payr 22 cm / 8 5/8"	





3124	HMI-SI-3244	Ligature Conductors Modell Wien Ligature Catcher 23,5 cm / 9 2/8"	
3125	HMI-SI-3245	Ligature Conductors Bozemann Knot Tier 22 cm / 8 5/8"	
3126	HMI-SI-3246	Ligature Conductors Ligature Adjuster 23 cm / 9"	
3127	HMI-SI-3247	Clip Applying Forceps Childe 17 cm / 6 6/8" Approximation Forceps heavy pattern, with clip holder	
3128	HMI-SI-3248	Clip Applying Forceps Michel 12 cm / 4 6/8"	
3129	HMI-SI-3249	Clip Applying Forceps Hegenbarth 12 cm / 4 6/8"	
3130	HMI-SI-3250	Clip Applying Forceps Wachenfeldt 12 cm / 4 6/8"	
3131	HMI-SI-3251	Clip Applying Forceps Michel 12,5 cm / 4 7/8" for applying and removal of clips	





3132	HMI-SI-3252	Clip Applying Forceps Michel 13 cm / 4" long jaw, for applying and removal of clips	
3133	HMI-SI-3253	Clip Applying Forceps Richter 13,5 cm / 5 3/8" screw lock	
3134	HMI-SI-3254	Bandage Scissors Lorenz heavy pattern 24 cm / 9 4/8"	
3135	HMI-SI-3255	Bandage Scissors 14,5 cm / 5 6/8"	
3136	HMI-SI-3256	Bandage Scissors Lister 14,5 cm / 5 6/8"	
3137	HMI-SI-3257	Bandage Scissors Lister 18,5 cm / 7 2/8"	
3138	HMI-SI-3258	Bandage Scissors Lister 20 cm / 7 7/8"	
3139	HMI-SI-3259	Plaster Shears Bergmann heavy pattern 23 cm / 9"	





3140	HMI-SI-3260	Plaster Shears Esmarch heavy pattern, short blades 20 cm / 7 7/8"	
3141	HMI-SI-3261	Bandage Scissors, Plaster Shears Bruns 24 cm / 9 4/8" one toothed cutting edge	
3142	HMI-SI-3262	Bandage Scissors, Plaster Shears Bruns 24 cm / 9 4/8"	
3143	HMI-SI-3263	Bandage Scissors, Plaster Shears Universal 15,5 cm / 6 1/8" black plastic rings, autoclavable	
3144	HMI-SI-3264	Bandage Scissors, Plaster Shears Universal 19 cm / 7 4/8" black plastic rings, autoclavable	
3145	HMI-SI-3265	Plaster Shears Stille-Martin 23 cm / 9"	
3146	HMI-SI-3266	Plaster Shears Stille-Martin 27 cm / 10 5/8"	
3147	HMI-SI-3267	Plaster Shears Stille-Martin 38 cm / 15"	
3148	HMI-SI-3268	Plaster Shears Stille-Martin 23 cm / 9" Spare Blade	
3149	HMI-SI-3269	Plaster Shears Stille-Martin 27 cm / 10 5/8" Spare Blade	
3150	HMI-SI-3270	Plaster Shears Stille-Martin 38 cm / 15" Spare Blade	
3151	HMI-SI-3271	Bandage Scissors, Plaster Shears TCGOLD Lister 18 cm / 7 1/8"	





3152	HMI-SI-3272	Bandage Scissors, Plaster Shears TCGOLD Bruns 23,5 cm / 9 2/8"	
3153	HMI-SI-3273	Plaster Knives Hopkins with wooden handle 20 cm / 7 7/8"	
3154	HMI-SI-3274	Plaster Knives Esmarch 18 cm / 7 1/8"	
3155	HMI-SI-3275	Plaster Knives Reiner 18 cm / 7 1/8"	
3156	HMI-SI-3276	Plaster Knives Martin with wooden handle 20,5 cm / 8 1/8"	
3157	HMI-SI-3277	Plaster Spreaders Hennig 28 cm / 11"	
3158	HMI-SI-3278	Plaster Spreaders Quattro 23 cm / 9"	
3159	HMI-SI-3279	Plaster Breakers Wol, 17,5 cm / 6 7/8"	





3160	HMI-SI-3280	Plaster Breakers Wol, 26,5 cm / 10 3/8"		
3161	HMI-SI-3281	Bone Chisels, Gouges Virchow Skull Breaker 7,5 cm / 3 "		
3162	HMI-SI-3282	Bone Chisels, Gouges 17 cm / 6 6/8" 4mm		
3163	HMI-SI-3283	Bone Chisels, Gouges 17 cm / 6 6/8" 4mm		
3164	HMI-SI-3284	Bone Chisels, Gouges Gardner 17 cm / 6 6/8" triangular shape 4 mm		
3165	HMI-SI-3285	Bone Chisels, Gouges Gardner 17 cm / 6 6/8" triangular shape 4 mm		
3166	HMI-SI-3286	Bone Chisels, Gouges Gardner 17 cm / 6 6/8" triangular shape 4 mm		
3167	HMI-SI-3288	Bone Chisels, Gouges Snyder-O.S.U 16,5 cm / 6 2/8" 3 mm		





3168	HMI-SI-3289	Bone Chisels, Gouges Snyder-O.S.U 16,5 cm / 6 2/8" 3 mm	
3169	HMI-SI-3291	Osteotomes, Chisels, Gouges 13,5 cm / 5 3/8" 8 mm	
3170	HMI-SI-3292	Osteotomes, Chisels, Gouges 13,5 cm / 5 3/8" 10 mm	
3171	HMI-SI-3293	Osteotomes, Chisels, Gouges 13,5 cm / 5 3/8" 12 mm	
3172	HMI-SI-3294	Osteotomes, Chisels, Gouges 13,5 cm / 5 3/8" 14 mm	
3173	HMI-SI-3295	Osteotomes, Chisels, Gouges 13,5 cm / 5 3/8" 16 mm	
3174	HMI-SI-3296	Osteotomes, Chisels, Gouges 13,5 cm / 5 3/8" 8 mm	
3175	HMI-SI-3297	Osteotomes, Chisels, Gouges 13,5 cm / 5 3/8" 10 mm	
3176	HMI-SI-3298	Osteotomes, Chisels, Gouges 13,5 cm / 5 3/8" 12 mm	
3177	HMI-SI-3299	Osteotomes, Chisels, Gouges 13,5 cm / 5 3/8" 14 mm	
3178	HMI-SI-3300	Osteotomes, Chisels, Gouges 13,5 cm / 5 3/8" 16 mm	
3179	HMI-SI-3301	Osteotomes, Chisels, Gouges 13,5 cm / 5 3/8" 8 mm	
3180	HMI-SI-3302	Osteotomes, Chisels, Gouges 13,5 cm / 5 3/8" 10 mm	
3181	HMI-SI-3303	Osteotomes, Chisels, Gouges 13,5 cm / 5 3/8" 12 mm	
3182	HMI-SI-3304	Osteotomes, Chisels, Gouges 13,5 cm / 5 3/8" 14 mm	
3183	HMI-SI-3305	Osteotomes, Chisels, Gouges 13,5 cm / 5 3/8" 16 mm	
3184	HMI-SI-3306	Chisels Partsch 13,5 cm / 5 3/8" 2 mm	
3185	HMI-SI-3307	Chisels Partsch 17 cm / 6 6/8" 2 mm	
3186	HMI-SI-3308	Chisels Partsch 13,5 cm / 5 3/8" 3 mm	
3187	HMI-SI-3309	Chisels Partsch 17 cm / 6 6/8" 3 mm	
3188	HMI-SI-3310	Chisels Partsch 13,5 cm / 5 3/8" 4 mm	
3189	HMI-SI-3311	Chisels Partsch 17 cm / 6 6/8" 4 mm	
3190	HMI-SI-3312	Chisels Partsch 13,5 cm / 5 3/8" 5 mm	

3191	HMI-SI-3313	Chisels Partsch 17 cm / 6 6/8" 5 mm		
3192	HMI-SI-3314	Chisels Partsch 13,5 cm / 5 3/8" 6 mm		
3193	HMI-SI-3315	Chisels Partsch 17 cm / 6 6/8" 6 mm		
3194	HMI-SI-3316	Chisels Partsch 13,5 cm / 5 3/8" 2 mm		
3195	HMI-SI-3317	Chisels Partsch 17 cm / 6 6/8" 2 mm		
3196	HMI-SI-3318	Chisels Partsch 13,5 cm / 5 3/8" 3 mm		
3197	HMI-SI-3319	Chisels Partsch 17 cm / 6 6/8" 3 mm		
3198	HMI-SI-3320	Chisels Partsch 13,5 cm / 5 3/8" 4 mm		
3199	HMI-SI-3321	Chisels Partsch 17 cm / 6 6/8" 4 mm		
3200	HMI-SI-3322	Chisels Partsch 13,5 cm / 5 3/8" 5 mm		
3201	HMI-SI-3323	Chisels Partsch 17 cm / 6 6/8" 5 mm		
3202	HMI-SI-3324	Chisels Partsch 13,5 cm / 5 3/8" 6 mm		
3203	HMI-SI-3325	Chisels Partsch 17 cm / 6 6/8" 6 mm		
3204	HMI-SI-3326	Chisels Zielke 23 cm / 9" 5,5 mm		
3205	HMI-SI-3327	Chisels Zielke 23 cm / 9" 9 mm		
3206	HMI-SI-3328	Chisels Zielke Alexander solid 17,5 cm / 6 7/8" 4 mm		
3207	HMI-SI-3329	Chisels Zielke Alexander solid 17,5 cm / 6 7/8" 6 mm		
3208	HMI-SI-3330	Chisels Zielke Alexander solid 17,5 cm / 6 7/8" 8 mm		
3209	HMI-SI-3331	Chisels Zielke Alexander solid 17,5 cm / 6 7/8" 10 mm		
3210	HMI-SI-3332	Chisels Zielke Alexander solid 17,5 cm / 6 7/8" 12 mm		
3211	HMI-SI-3333	Chisels Zielke Alexander solid 17,5 cm / 6 7/8" 14 mm		

3212	HMI-SI-3334(a)	Chisels Zielke Alexander solid 17,5 cm / 6 7/8" 4 mm	
3213	HMI-SI-3334	Chisels Zielke Alexander solid 17,5 cm / 6 7/8" 6 mm	
3214	HMI-SI-3335	Chisels Zielke Alexander solid 17,5 cm / 6 7/8" 8 mm	
3215	HMI-SI-3336	Chisels Zielke Alexander solid 17,5 cm / 6 7/8" 10 mm	
3216	HMI-SI-3337	Chisels Zielke Alexander solid 17,5 cm / 6 7/8" 12 mm	
3217	HMI-SI-3338	Chisels Zielke Alexander solid 17,5 cm / 6 7/8" 14 mm	
3218	HMI-SI-3339	Chisels, Osteotomes Stille 20,5 cm / 8 1/8" 10 mm	
3219	HMI-SI-3340	Chisels, Osteotomes Stille 20,5 cm / 8 1/8" 12 mm	
3220	HMI-SI-3341	Chisels, Osteotomes Stille 20,5 cm / 8 1/8" 15 mm	
3221	HMI-SI-3342	Chisels, Osteotomes Stille 20,5 cm / 8 1/8" 20 mm	
3222	HMI-SI-3343	Chisels, Osteotomes Stille 20,5 cm / 8 1/8" 25 mm	
3223	HMI-SI-3344	Chisels, Osteotomes Stille 20,5 cm / 8 1/8" 10 mm	
3224	HMI-SI-3345	Chisels, Osteotomes Stille 20,5 cm / 8 1/8" 12 mm	
3225	HMI-SI-3346	Chisels, Osteotomes Stille 20,5 cm / 8 1/8" 15 mm	
3226	HMI-SI-3347	Chisels, Osteotomes Stille 20,5 cm / 8 1/8" 20 mm	
3227	HMI-SI-3348	Chisels, Osteotomes Stille 20,5 cm / 8 1/8" 25 mm	
3228	HMI-SI-3349	Chisels, Gouges Stille 20,5 cm / 8 1/8" delicate 10 mm	
3229	HMI-SI-3350	Chisels, Gouges Stille 20,5 cm / 8 1/8" delicate 12 mm	
3230	HMI-SI-3351	Chisels, Gouges Stille 20,5 cm / 8 1/8" delicate 15 mm	
3231	HMI-SI-3352	Chisels, Gouges Stille 20,5 cm / 8 1/8" delicate 20 mm	
3232	HMI-SI-3353	Chisels, Gouges Stille 20,5 cm / 8 1/8" delicate 25 mm	
3233	HMI-SI-3354	Chisels, Gouges Stille 20,5 cm / 8 1/8" 10 mm	
3234	HMI-SI-3355	Chisels, Gouges Stille 20,5 cm / 8 1/8" 12 mm	
3235	HMI-SI-3356	Chisels, Gouges Stille 20,5 cm / 8 1/8" 15 mm	

3236	HMI-SI-3357	Chisels, Gouges Stille 20,5 cm / 8 1/8" 20 mm	
3237	HMI-SI-3358	Chisels, Gouges Stille 20,5 cm / 8 1/8" 25 mm	
3238	HMI-SI-3359	Chisel Blades, Chisel Handle Gouge blades, interchangeable r = 50 mm 25 mm 13,5 cm / 5 3/8"	
3239	HMI-SI-3360	Chisel Blades, Chisel Handle r = 60 mm 25 mm 13,5 cm / 5 3/8"	
3240	HMI-SI-3361	Chisel Blades, Chisel Handle r = 70 mm 25 mm 13,5 cm / 5 3/8"	
3241	HMI-SI-3362	Chisel Blades, Chisel Handle 18,5 cm / 7 2/8"	
3242	HMI-SI-3363	Chisel Blades, Chisel Handle Spare Screw 18,5 cm / 7 2/8"	
3243	HMI-SI-3364	Chisel Blades, Chisel Handle 18 cm / 3 1/8" 5 mm	
3244	HMI-SI-3365	Chisel Blades, Chisel Handle 18 cm / 3 1/8" 10 mm	
3245	HMI-SI-3366	Chisel Blades, Chisel Handle 18 cm / 3 1/8" 16 mm	
3246	HMI-SI-3367	Chisel Blades, Chisel Handle 18 cm / 3 1/8" 25 mm	
3247	HMI-SI-3368	Chisel Blades, Chisel Handle Key	
3248	HMI-SI-3369	Chisel Blades, Chisel Handle 18 cm / 3 1/8" 5 mm	
3249	HMI-SI-3370	Chisel Blades, Chisel Handle 18 cm / 3 1/8" 10 mm	
3250	HMI-SI-3371	Chisel Blades, Chisel Handle 18 cm / 3 1/8" 16 mm	
3251	HMI-SI-3372	Chisel Blades, Chisel Handle 18 cm / 3 1/8" 25 mm	
3252	HMI-SI-3373	Spongiosa Gouges Lexer 24,5 cm / 9 5/8" 5 mm	

3253	HMI-SI-3374	Spongiosa Gouges Lexer 24,5 cm / 9 5/8" 10 mm	
3254	HMI-SI-3375	Spongiosa Gouges Lexer 24,5 cm / 9 5/8" 15 mm	
3255	HMI-SI-3376	Spongiosa Gouges Lexer 24,5 cm / 9 5/8" 5 mm	
3256	HMI-SI-3377	Spongiosa Gouges Lexer 24,5 cm / 9 5/8" 10 mm	
3257	HMI-SI-3378	Spongiosa Gouges Lexer 24,5 cm / 9 5/8" 15 mm	
3258	HMI-SI-3379	Osteotomes, Gouges Lexer-Mini 18 cm / 7 1/8" 4 mm	
3259	HMI-SI-3380	Osteotomes, Gouges Lexer-Mini 18 cm / 7 1/8" 6 mm	
3260	HMI-SI-3381	Osteotomes, Gouges Lexer-Mini 18 cm / 7 1/8" 8 mm	
3261	HMI-SI-3382	Osteotomes, Gouges Lexer-Mini 18 cm / 7 1/8" 10 mm	
3262	HMI-SI-3383	Osteotomes, Gouges Lexer-Mini 18 cm / 7 1/8" 12 mm	
3263	HMI-SI-3384	Osteotomes, Gouges Lexer-Mini 18 cm / 7 1/8" 4 mm	
3264	HMI-SI-3385	Osteotomes, Gouges Lexer-Mini 18 cm / 7 1/8" 6 mm	
3265	HMI-SI-3386	Osteotomes, Gouges Lexer-Mini 18 cm / 7 1/8" 8 mm	
3266	HMI-SI-3387	Osteotomes, Gouges Lexer-Mini 18 cm / 7 1/8" 10 mm	
3267	HMI-SI-3388	Osteotomes, Gouges Lexer-Mini 18 cm / 7 1/8" 12 mm	





3268	HMI-SI-3389	Osteotomes, Gouges Lexer 22 cm / 8 5/8" 5 mm	
3269	HMI-SI-3390	Osteotomes, Gouges Lexer 22 cm / 8 5/8" 7 mm	
3270	HMI-SI-3391	Osteotomes, Gouges Lexer 22 cm / 8 5/8" 10 mm	
3271	HMI-SI-3392	Osteotomes, Gouges Lexer 22 cm / 8 5/8" 15 mm	
3272	HMI-SI-3393	Osteotomes, Gouges Lexer 22 cm / 8 5/8" 20 mm	
3273	HMI-SI-3394	Osteotomes, Gouges Lexer 22 cm / 8 5/8" 25 mm	
3274	HMI-SI-3395	Osteotomes, Gouges Lexer 22 cm / 8 5/8" 30 mm	
3275	HMI-SI-3396	Osteotomes, Gouges Lexer 22 cm / 8 5/8" 5 mm	
3276	HMI-SI-3397	Osteotomes, Gouges Lexer 22 cm / 8 5/8" 7 mm	
3277	HMI-SI-3398	Osteotomes, Gouges Lexer 22 cm / 8 5/8" 10 mm	
3278	HMI-SI-3399	Osteotomes, Gouges Lexer 22 cm / 8 5/8" 15 mm	
3279	HMI-SI-3400	Osteotomes, Gouges Lexer 22 cm / 8 5/8" 20 mm	
3280	HMI-SI-3401	Osteotomes, Gouges Lexer 22 cm / 8 5/8" 25 mm	
3281	HMI-SI-3402	Osteotomes, Gouges Lexer 22 cm / 8 5/8" 30 mm	
3282	HMI-SI-3403	Osteotomes Lambotte-Mini 12,5 cm / 4 7/8" 2 mm	
3283	HMI-SI-3404	Osteotomes Lambotte-Mini 12,5 cm / 4 7/8" 3 mm	
3284	HMI-SI-3405	Osteotomes Lambotte-Mini 12,5 cm / 4 7/8" 4 mm	
3285	HMI-SI-3406	Osteotomes Lambotte-Mini 12,5 cm / 4 7/8" 6 mm	
3286	HMI-SI-3407	Osteotomes Lambotte-Mini 12,5 cm / 4 7/8" 8 mm	
3287	HMI-SI-3408	Osteotomes Lambotte-Mini 12,5 cm / 4 7/8" 10 mm	
3288	HMI-SI-3409	Osteotomes Lambotte-Mini 12,5 cm / 4 7/8" 12 mm	
3289	HMI-SI-3410	Osteotomes Lambotte-Mini 12,5 cm / 4 7/8" 15 mm	
3290	HMI-SI-3411	Osteotomes Lambotte-Mini 17 cm / 6 6/8" 3 mm	
3291	HMI-SI-3412	Osteotomes Lambotte-Mini 17 cm / 6 6/8" 4 mm	
3292	HMI-SI-3413	Osteotomes Lambotte-Mini 17 cm / 6 6/8" 6 mm	





3293	HMI-SI-3414	Osteotomes Lambotte-Mini 17 cm / 6 6/8" 8 mm
3294	HMI-SI-3415	Osteotomes Lambotte-Mini 17 cm / 6 6/8" 10 mm
3295	HMI-SI-3416	Osteotomes Lambotte-Mini 17 cm / 6 6/8" 12 mm
3296	HMI-SI-3417	Osteotomes Lambotte-Mini 17 cm / 6 6/8" 15 mm
3297	HMI-SI-3418	Osteotomes Lambotte 24 cm / 9 4/8" 4 mm
3298	HMI-SI-3419	Osteotomes Lambotte 24 cm / 9 4/8" 6 mm
3299	HMI-SI-3420	Osteotomes Lambotte 24 cm / 9 4/8" 8 mm
3300	HMI-SI-3421	Osteotomes Lambotte 24 cm / 9 4/8" 10 mm
3301	HMI-SI-3422	Osteotomes Lambotte 24 cm / 9 4/8" 13 mm
3302	HMI-SI-3423	Osteotomes Lambotte 24 cm / 9 4/8" 15 mm
3303	HMI-SI-3424	Osteotomes Lambotte 24 cm / 9 4/8" 18 mm
3304	HMI-SI-3425	Osteotomes Lambotte 24 cm / 9 4/8" 20 mm
3305	HMI-SI-3426	Osteotomes Lambotte 24 cm / 9 4/8" 25 mm
3306	HMI-SI-3427	Osteotomes Lambotte 24 cm / 9 4/8" 30 mm
3307	HMI-SI-3428	Osteotomes Lambotte 24 cm / 9 4/8" 38 mm
3308	HMI-SI-3429	Osteotomes Lambotte 24 cm / 9 4/8" 44 mm
3309	HMI-SI-3430	Osteotomes Lambotte 24 cm / 9 4/8" 50 mm
3310	HMI-SI-3431	Osteotomes Lambotte 24 cm / 9 4/8" 4 mm
3311	HMI-SI-3432	Osteotomes Lambotte 24 cm / 9 4/8" 6 mm
3312	HMI-SI-3433	Osteotomes Lambotte 24 cm / 9 4/8" 8 mm
3313	HMI-SI-3434	Osteotomes Lambotte 24 cm / 9 4/8" 10 mm
3314	HMI-SI-3435	Osteotomes Lambotte 24 cm / 9 4/8" 13 mm
3315	HMI-SI-3436	Osteotomes Lambotte 24 cm / 9 4/8" 15 mm
3316	HMI-SI-3437	Osteotomes Lambotte 24 cm / 9 4/8" 18 mm
3317	HMI-SI-3438	Osteotomes Lambotte 24 cm / 9 4/8" 20 mm











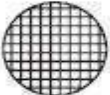

3318	HMI-SI-3439	Osteotomes Lambotte 24 cm / 9 4/8" 25 mm
3319	HMI-SI-3440	Osteotomes Lambotte 24 cm / 9 4/8" 30 mm
3320	HMI-SI-3441	Osteotomes Lambotte 24 cm / 9 4/8" 38 mm
3321	HMI-SI-3442	Osteotomes Lambotte 24 cm / 9 4/8" 44 mm
3322	HMI-SI-3443	Osteotomes Lambotte 24 cm / 9 4/8" 50 mm
3323	HMI-SI-3444	Osteotomes Smith-Petersen 20,5 cm / 8 1/8" 6 mm
3324	HMI-SI-3445	Osteotomes Smith-Petersen 20,5 cm / 8 1/8" 9 mm
3325	HMI-SI-3446	Osteotomes Smith-Petersen 20,5 cm / 8 1/8" 13 mm
3326	HMI-SI-3447	Osteotomes Smith-Petersen 20,5 cm / 8 1/8" 16 mm
3327	HMI-SI-3448	Osteotomes Smith-Petersen 20,5 cm / 8 1/8" 19 mm
3328	HMI-SI-3449	Osteotomes Smith-Petersen 20,5 cm / 8 1/8" 25 mm
3329	HMI-SI-3450	Osteotomes Smith-Petersen 20,5 cm / 8 1/8" 32 mm
3330	HMI-SI-3451	Osteotomes Smith-Petersen 20,5 cm / 8 1/8" 6 mm
3331	HMI-SI-3452	Osteotomes Smith-Petersen 20,5 cm / 8 1/8" 9 mm
3332	HMI-SI-3453	Osteotomes Smith-Petersen 20,5 cm / 8 1/8" 13 mm
3333	HMI-SI-3454	Osteotomes Smith-Petersen 20,5 cm / 8 1/8" 16 mm
3334	HMI-SI-3455	Osteotomes Smith-Petersen 20,5 cm / 8 1/8" 19 mm
3335	HMI-SI-3456	Osteotomes Smith-Petersen 20,5 cm / 8 1/8" 25 mm
3336	HMI-SI-3457	Osteotomes Smith-Petersen 20,5 cm / 8 1/8" 32 mm
3337	HMI-SI-3458	Gouges Smith-Petersen 20,5 cm / 8 1/8" 9mm
3338	HMI-SI-3459	Gouges Smith-Petersen 20,5 cm / 8 1/8" 14mm
3339	HMI-SI-3460	Gouges Smith-Petersen 20,5 cm / 8 1/8" 19mm
3340	HMI-SI-3461	Gouges Smith-Petersen 20,5 cm / 8 1/8" 25mm
3341	HMI-SI-3462	Gouges Smith-Petersen 20,5 cm / 8 1/8" 9mm
3342	HMI-SI-3463	Gouges Smith-Petersen 20,5 cm / 8 1/8" 14mm

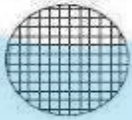

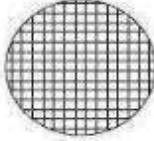
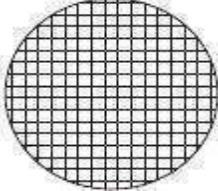













3343	HMI-SI-3464	Gouges Smith-Petersen 20,5 cm/ 8 1/," 19mm		
3344	HMI-SI-3465	Gouges Smith-Petersen 20,5 cm/ 8 1/," 25mm		
3345	HMI-SI-3466	Gouges Cobb 28cm/11" 6 mm		
3346	HMI-SI-3467	Gouges Cobb 28cm/11" 6 mm		
3347	HMI-SI-3468	Gouges Cobb 28cm/11" 6 mm		
3348	HMI-SI-3469	Gouges Cobb 28cm/11" 6 mm		
3349	HMI-SI-3470	Osteotomes, Chisels Hoke 17cm/6 '1/s" 3mm		
3350	HMI-SI-3471	Osteotomes, Chisels Hoke 17cm/6 '1/s" 5mm		
3351	HMI-SI-3472	Osteotomes, Chisels Hoke 17cm/6 '1/s" 6mm		
3352	HMI-SI-3473	Osteotomes, Chisels Hoke 17cm/6 '1/s" 8mm		
3353	HMI-SI-3474	Osteotomes, Chisels Hoke 17cm/6 '1/s" 9mm		
3354	HMI-SI-3475	Osteotomes, Chisels Hibbs 24,5 cm/ 9 5/s" 6mm		
3355	HMI-SI-3476	Osteotomes, Chisels Hibbs 24,5 cm/ 9 5/s" 13mm		
3356	HMI-SI-3477	Osteotomes, Chisels Hibbs 24,5 cm/ 9 5/s" 19mm		
3357	HMI-SI-3478	Osteotomes, Chisels Hibbs 24,5 cm/ 9 5/s" 25mm		
3358	HMI-SI-3479	Osteotomes, Chisels Hibbs 24,5 cm/ 9 5/s" 32mm		
3359	HMI-SI-3480	Osteotomes, Chisels Hibbs 24,5 cm/ 9 5/s" 6mm		

3360	HMI-SI-3481	Osteotomes, Chisels Hibbs 24,5 cm/ 9 5/s" 13mm	
3361	HMI-SI-3482	Osteotomes, Chisels Hibbs 24,5 cm/ 9 5/s" 19mm	
3362	HMI-SI-3483	Osteotomes, Chisels Hibbs 24,5 cm/ 9 5/s" 25mm	
3363	HMI-SI-3484	Osteotomes, Chisels Hibbs 24,5 cm/ 9 5/s" 32mm	
3364	HMI-SI-3485	Osteotomes, Chisels Hibbs 24,5 cm/ 9 1/2," 6 mm	
3365	HMI-SI-3486	Osteotomes, Chisels Hibbs 24,5 cm/ 9 1/2," 13 mm	
3366	HMI-SI-3487	Osteotomes, Chisels Hibbs 24,5 cm/ 9 1/2," 19 mm	
3367	HMI-SI-3488	Osteotomes, Chisels Hibbs 24,5 cm/ 9 1/2," 25 mm	
3368	HMI-SI-3489	Osteotomes, Chisels Hibbs 24,5 cm/ 9 1/2," 32 mm	
3369	HMI-SI-3490	Osteotomes, Chisels Hibbs 24,5 cm/ 9 1/2," 6 mm	
3370	HMI-SI-3491	Osteotomes, Chisels Hibbs 24,5 cm/ 9 1/2," 13 mm	
3371	HMI-SI-3492	Osteotomes, Chisels Hibbs 24,5 cm/ 9 1/2," 19 mm	
3372	HMI-SI-3493	Osteotomes, Chisels Hibbs 24,5 cm/ 9 1/2," 25 mm	
3373	HMI-SI-3494	Osteotomes, Chisels Hibbs 24,5 cm/ 9 1/2," 32 mm	
3374	HMI-SI-3495	Osteotomes, Chisels Hibbs 24,5 cm/ 9 1/2," 6 mm	
3375	HMI-SI-3496	Osteotomes, Chisels Hibbs 24,5 cm/ 9 1/2," 13 mm	
3376	HMI-SI-3497	Osteotomes, Chisels Hibbs 24,5 cm/ 9 1/2," 19 mm	
3377	HMI-SI-3498	Osteotomes, Chisels Hibbs 24,5 cm/ 9 1/2," 25 mm	
3378	HMI-SI-3499	Osteotomes, Chisels Hibbs 24,5 cm/ 9 1/2," 32 mm	
3379	HMI-SI-3500	Bone Rasps Putti 30 cm 11 1/2," round/ semi round	
3380	HMI-SI-3501	Bone Rasps Putti 27 cm / 10 5/8" curved / straight	

3381	HMI-SI-3502	Tamper Caspar 22cm/8 5/a" Ø 3 mm		
3382	HMI-SI-3503	Tamper Caspar 22cm/8 5/a" Ø 5 mm		
3383	HMI-SI-3504	Tamper Caspar 22cm/8 5/a" Ø 8 mm		
3384	HMI-SI-3505	Tamper Caspar 15,5 cm/ 6 1/a" Ø 2 mm		
3385	HMI-SI-3506	Tamper Caspar 15,5 cm/ 6 1/a" Ø 3 mm		
3386	HMI-SI-3507	Tamper Caspar 15,5 cm/ 6 1/a" Ø 4 mm		
3387	HMI-SI-3508	Tamper Caspar 15,5 cm/ 6 1/a" Ø 5 mm		
3388	HMI-SI-3509	Tamper Caspar 15,5 cm/ 6 1/a" Ø 6 mm		
3389	HMI-SI-3510	Tamper Caspar 15,5 cm/ 6 1/a" Ø 8 mm		
3390	HMI-SI-3511	Tamper Caspar 15,5 cm/ 6 1/a" Ø 10 mm		
3391	HMI-SI-3512	Tamper Caspar 20 cm/ 8" Ø 12 mm		
3392	HMI-SI-3513	Tamper Caspar 20 cm/ 8" Ø 14 mm		
3393	HMI-SI-3514	Tamper Caspar 20 cm/ 8" Ø 16 mm		



3394	HMI-SI-3515	Mallets Williger 24 cm / 9 4/8" 275 g Ø 26 mm	
3395	HMI-SI-3516	Mallets Williger 24 cm / 9 4/8" 320 g Ø 28 mm	
3396	HMI-SI-3517	Mallets Williger 24 cm / 9 4/8" 340 g Ø 30 mm	
3397	HMI-SI-3518	Mallets Doyen 20,5 cm / 8 1/8" 120 g Ø 25 mm	
3398	HMI-SI-3519	Mallets Doyen 21 cm / 8 2/8" 170 g Ø 30 mm	
3399	HMI-SI-3520	Mallets Doyen 21,5 cm / 8 4/8" 260 g Ø 35 mm	
3400	HMI-SI-3520(a)	Mallets Collin 20cm/7 1/8" 220 g Ø 30 mm	
3401	HMI-SI-3521	Mallets Lucae 19,5 cm / 7 5/8" Ø 19 mm 230 g	

3402	HMI-SI-3522	Mallets Lucae 19,5 cm / 7 5/8" Ø 25 mm 260 g	
3403	HMI-SI-3523	Mallets Cottle 19 cm / 7 4/8" plane / convex Ø 30 mm 300 g	
3404	HMI-SI-3524	Mallets Williger 16,5 cm / 6 4/8" Ø 20 mm 140g	
3405	HMI-SI-3525	Mallets 26 cm / 10 2/8" Ø 30 mm 450g	
3406	HMI-SI-3526	Mallets Maed 19 cm / 7 4/8" with interchangeable plastic disks Ø 27 mm 330 g	
3407	HMI-SI-3527	Mallets Partsch 19 cm / 7 4/8" with hollow handle Ø 27 mm 175 g	
3408	HMI-SI-3527(a)	Mallets Partsch 19 cm / 7 4/8" with hollow handle	
3409	HMI-SI-3528	Mallets Spare facing	

3410	HMI-SI-3529	Mallets 26,5 cm / 10 3/8" plane (nylon), convex (steel) Ø 32 mm 620 g	
3411	HMI-SI-3530	Mallets 26 cm / 10 2/8" Ø 32 mm 610 g	
3412	HMI-SI-3531	Mallets 24 cm / 9 4/8" Ø 30 mm 460 g	
3413	HMI-SI-3532	Mallets 24 cm / 9 4/8" Ø 37 mm 345 g	
3414	HMI-SI-3533	Mallets Spare Facings (pair)	
3415	HMI-SI-3534	Mallets 26,5 cm / 10 3/8" Ø 30 mm 580 g	
3416	HMI-SI-3535	Mallets 26,5 cm / 10 3/8" Ø 50 mm 1300 g	
3417	HMI-SI-3536	Bone Curettes Volkmann 17cm/6 1/8" oval 2,5 mm	
3418	HMI-SI-3537	Bone Curettes Volkmann 17cm/6 1/8" oval 3,0 mm	
3419	HMI-SI-3538	Bone Curettes Volkmann 17cm/6 1/8" oval 3,5 mm	
3420	HMI-SI-3539	Bone Curettes Volkmann 17cm/6 1/8" oval 4,5 mm	

3421	HMI-SI-3540	Bone Currettes Volkmann 17cm/6 '/s" oval 5,5 mm
3422	HMI-SI-3541	Bone Currettes Volkmann 17cm/6 '/s" oval 6,0 mm
3423	HMI-SI-3542	Bone Currettes Volkmann 17cm/6 '/s" oval 7,0 mm
3424	HMI-SI-3543	Bone Currettes Volkmann 17cm/6 '/s" oval 8,5 mm
3425	HMI-SI-3544	Bone Currettes Volkmann 17cm/6 '/s" oval 9,5 mm
3426	HMI-SI-3545	Bone Currettes Volkmann 17cm/6 '/s" oval 11,5 mm
3427	HMI-SI-3546	Bone Currettes Volkmann 27 cm / 10 5/ 8" oval 4,5 mm
3428	HMI-SI-3547	Bone Currettes Volkmann 27 cm / 10 5/ 8" oval 5,5 mm
3429	HMI-SI-3548	Bone Currettes Volkmann 27 cm / 10 5/ 8" oval 6,0 mm
3430	HMI-SI-3549	Bone Currettes Volkmann 27 cm / 10 5/ 8" oval 7,0 mm
3431	HMI-SI-3550	Bone Currettes Volkmann 27 cm / 10 5/ 8" oval 8,5 mm
3432	HMI-SI-3551	Bone Currettes Schede 17 cm / 6 6/ 8" oval , with hollow handle 3,5mm
3433	HMI-SI-3552	Bone Currettes Schede 17 cm / 6 6/ 8" oval , with hollow handle 4mm
3434	HMI-SI-3553	Bone Currettes Schede 17 cm / 6 6/ 8" oval , with hollow handle 5mm
3435	HMI-SI-3554	Bone Currettes Schede 17 cm / 6 6/ 8" oval , with hollow handle 5,5mm
3436	HMI-SI-3555	Bone Currettes Schede 17 cm / 6 6/ 8" oval , with hollow handle 6,5mm
3437	HMI-SI-3556	Bone Currettes Schede 17 cm / 6 6/ 8" oval , with hollow handle 7,5mm
3438	HMI-SI-3557	Bone Currettes Schede 17 cm / 6 6/ 8" oval , with hollow handle 9,0mm
3439	HMI-SI-3558	Bone Currettes Schede 17 cm / 6 6/ 8" oval , with hollow handle 3,0mm
3440	HMI-SI-3559	Bone Currettes Schede 17 cm / 6 6/ 8" oval , with hollow handle 3,7mm



3441	HMI-SI-3560	Bone Curettes Schede 17 cm / 6 6/8" oval , with hollow handle 4,5mm	
3442	HMI-SI-3561	Bone Curettes Schede 17 cm / 6 6/8" oval , with hollow handle 5,2mm	
3443	HMI-SI-3562	Bone Curettes Schede 17 cm / 6 6/8" oval , with hollow handle 6,8mm	
3444	HMI-SI-3563	Bone Curettes Schede 17 cm / 6 6/8" oval , with hollow handle 8,5mm	
3445	HMI-SI-3564	Bone Curettes Schede 17 cm / 6 6/8" oval , with hollow handle 10,0mm	
3446	HMI-SI-3565	Bone Curettes Schede 17 cm / 6 6/8" oval , with hollow handle 11,5mm	
3447	HMI-SI-3566	Bone Curettes Schede 17 cm / 6 6/8" oval , with hollow handle 13,0mm	
3448	HMI-SI-3567	Bone Curettes Schede 17 cm / 6 6/8" oval , with hollow handle 14,5mm	
3449	HMI-SI-3568	Bone Curettes Schede 17 cm / 6 6/8" oval , with hollow handle 2,8mm	
3450	HMI-SI-3569	Bone Curettes Schede 17 cm / 6 6/8" oval , with hollow handle 3,6mm	
3451	HMI-SI-3570	Bone Curettes Schede 17 cm / 6 6/8" oval , with hollow handle 4,4mm	
3452	HMI-SI-3571	Bone Curettes Schede 17 cm / 6 6/8" oval , with hollow handle 5,2mm	

3453	HMI-SI-3572	Bone Currettes Bruns 17 cm / 6 6/8" round, with hollow handle \varnothing 2,0mm
3454	HMI-SI-3573	Bone Currettes Bruns 17 cm / 6 6/8" round, with hollow handle \varnothing 3,0 mm
3455	HMI-SI-3574	Bone Currettes Bruns 17 cm / 6 6/8" round, with hollow handle \varnothing 4,0mm
3456	HMI-SI-3575	Bone Currettes Bruns 17 cm / 6 6/8" round, with hollow handle \varnothing 5,0 mm
3457	HMI-SI-3576	Bone Currettes Bruns 17 cm / 6 6/8" round, with hollow handle \varnothing 6,0 mm
3458	HMI-SI-3577	Bone Currettes Bruns 17 cm / 6 6/8" round, with hollow handle \varnothing 8,0 mm
3459	HMI-SI-3578	Bone Currettes Bruns 17 cm / 6 6/8" round, with hollow handle \varnothing 10,0 mm
3460	HMI-SI-3579	Bone Currettes Bruns 17 cm / 6 6/8" round, with hollow handle \varnothing 12,0 mm
3461	HMI-SI-3580	Bone Currettes Bruns 17 cm / 6 6/8" round, with hollow handle \varnothing 13,0 mm
3462	HMI-SI-3581	Bone Currettes Bruns 17 cm / 6 6/8" round, with hollow handle \varnothing 14,0 mm
3463	HMI-SI-3582	Bone Currettes Spratt 17 cm / 6 6/8" oval, with hollow handle 2,5 mm
3464	HMI-SI-3583	Bone Currettes Spratt 17 cm / 6 6/8" oval, with hollow handle 3,0 mm
3465	HMI-SI-3584	Bone Currettes Spratt 17 cm / 6 6/8" oval, with hollow handle 4,0 mm
3466	HMI-SI-3585	Bone Currettes Spratt 17 cm / 6 6/8" oval, with hollow handle 4,5 mm
3467	HMI-SI-3586	Bone Currettes Spratt 17 cm / 6 6/8" oval, with hollow handle 5,0 mm
3468	HMI-SI-3586(a)	Bone Currettes Spratt 17 cm / 6 6/8" oval, with hollow handle 6,0 mm









3469	HMI-SI-3587	Bone Currettes Spratt 17 cm / 6 6/8" oval, with hollow handle 7,0 mm
3470	HMI-SI-3588	Bone Currettes Spratt 17 cm / 6 6/8" oval, with hollow handle 8,0 mm
3471	HMI-SI-3589	Bone Currettes Spratt 17 cm / 6 6/8" oval, with hollow handle 9,5 mm
3472	HMI-SI-3590	Bone Currettes Bruns 23 cm / 9 " oval, solid 3,5 mm
3473	HMI-SI-3591	Bone Currettes Bruns 23 cm / 9 " oval, solid 4,0 mm
3474	HMI-SI-3592	Bone Currettes Bruns 23 cm / 9 " oval, solid 4,5 mm
3475	HMI-SI-3593	Bone Currettes Bruns 23 cm / 9 " oval, solid 5,5 mm
3476	HMI-SI-3594	Bone Currettes Bruns 23 cm / 9 " oval, solid 6,0 mm
3477	HMI-SI-3595	Bone Currettes Bruns 23 cm / 9 " oval, solid 7,5 mm
3478	HMI-SI-3596	Bone Currettes Bruns 23 cm / 9 " oval, solid 8,5 mm
3479	HMI-SI-3597	Bone Currettes Bruns 23 cm / 9 " oval, solid 10,0 mm
3480	HMI-SI-3598	Bone Currettes Bruns 23 cm / 9 " oval, solid 11,5 mm
3481	HMI-SI-3599	Bone Currettes Scoville 25 cm / 9 7/8" oval, with hollow handle 4,8 mm
3482	HMI-SI-3599(a)	Bone Currettes Scoville 25 cm / 9 7/8" oval, with hollow handle 4,8 mm
3483	HMI-SI-3600	Bone Currettes Scoville 25 cm / 9 7/8" oval, with hollow handle 4,8 mm
3484	HMI-SI-3601	Bone Currettes Simon 22,5 cm / 8 7/8" oval, with hollow handle 2,5mm











3485	HMI-SI-3601(a)	Bone Curettes Simon 22,5 cm / 8 7/8" oval, with hollow handle 3,0mm
3486	HMI-SI-3602	Bone Curettes Simon 22,5 cm / 8 7/8" oval, with hollow handle 3,5mm
3487	HMI-SI-3603	Bone Curettes Simon 22,5 cm / 8 7/8" oval, with hollow handle 4,0mm
3488	HMI-SI-3604	Bone Curettes Simon 22,5 cm / 8 7/8" oval, with hollow handle 4,5mm
3489	HMI-SI-3605	Bone Curettes Simon 22,5 cm / 8 7/8" oval, with hollow handle 5,5mm
3490	HMI-SI-3606	Bone Curettes 25 cm / 9 7/8" oval, with hollow handle 3,5 mm
3491	HMI-SI-3607	Bone Curettes 25 cm / 9 7/8" oval, with hollow handle 4,5 mm
3492	HMI-SI-3608	Bone Curettes 25 cm / 9 7/8" oval, with hollow handle 5,0 mm
3493	HMI-SI-3609	Bone Curettes 25 cm / 9 7/8" oval, with hollow handle 6,0 mm
3494	HMI-SI-3610	Bone Curettes Modell USA 16,5 cm / 6 4/8" oval, with hollow handle 2,3 mm
3495	HMI-SI-3611	Bone Curettes Modell USA 16,5 cm / 6 4/8" oval, with hollow handle 2,6 mm
3496	HMI-SI-3612	Bone Curettes Modell USA 16,5 cm / 6 4/8" oval, with hollow handle 3,0 mm



3497	HMI-SI-3613	Bone Currettes Modell USA 16,5 cm / 6 4/ 8" oval, with hollow handle 3,5 mm	
3498	HMI-SI-3614	Bone Currettes Modell USA 16,5 cm / 6 4/ 8" oval, with hollow handle 4,5 mm	
3499	HMI-SI-3615	Bone Currettes Modell USA 16,5 cm / 6 4/ 8" oval, with hollow handle 5,0 mm	
3500	HMI-SI-3616	Bone Currettes Modell USA 16 cm / 6 2/ 8" oval, with hollow handlem 2,3 mm	
3501	HMI-SI-3617	Bone Currettes Modell USA 16 cm / 6 2/ 8" oval, with hollow handlem 2,6 mm	
3502	HMI-SI-3618	Bone Currettes Modell USA 16 cm / 6 2/ 8" oval, with hollow handlem 3,0 mm	
3503	HMI-SI-3619	Bone Currettes Modell USA 16 cm / 6 2/ 8" oval, with hollow handlem 3,5 mm	
3504	HMI-SI-3620	Bone Currettes Modell USA 16 cm / 6 2/ 8" oval, with hollow handlem 4,5 mm	
3505	HMI-SI-3621	Bone Currettes Modell USA 16 cm / 6 2/ 8" oval, with hollow handlem 5,0 mm	
3506	HMI-SI-3622	Bone Currettes Modell USA 16,5 cm / 6 4/ 8" oval, with hollow handle 2,3 mm	
3507	HMI-SI-3623	Bone Currettes Modell USA 16,5 cm / 6 4/ 8" oval, with hollow handle 2,6 mm	
3508	HMI-SI-3624	Bone Currettes Modell USA 16,5 cm / 6 4/ 8" oval, with hollow handle 3,0 mm	
3509	HMI-SI-3625	Bone Currettes Modell USA 16,5 cm / 6 4/ 8" oval, with hollow handle 3,5 mm	
3510	HMI-SI-3626	Bone Currettes Modell USA 16,5 cm / 6 4/ 8" oval, with hollow handle 4,5 mm	
3511	HMI-SI-3627	Bone Currettes Modell USA 16,5 cm / 6 4/ 8" oval, with hollow handle 5,0 mm	









3512	HMI-SI-3628	Bone Currettes Bushe 25 cm / 9 7/8" oval, with hollow handle 3,0 mm	
3513	HMI-SI-3629	Bone Currettes Bushe 25 cm / 9 7/8" oval, with hollow handle 4,0 mm	
3514	HMI-SI-3630	Bone Currettes Bushe 25 cm / 9 7/8" oval, with hollow handle 5,0 mm	
3515	HMI-SI-3631	Bone Currettes Halle 21 cm / 8 2/8" oval, malleable shaft, with hollow handle 4,8 mm	
3516	HMI-SI-3632	Bone Currettes Halle 21 cm / 8 2/8" oval, malleable shaft, with hollow handle 5,8 mm	
3517	HMI-SI-3633	Bone Currettes Halle 21 cm / 8 2/8" oval, malleable shaft, with hollow handle 6,8 mm	
3518	HMI-SI-3634	Bone Currettes Jacobson 14 cm / 5 4/8"	
3519	HMI-SI-3635	Bone Currettes Volkmann 12,5 cm / 4 7/8"	







3520	HMI-SI-3636	Bone Currettes Volkmann 14,5 cm / 5 6/8"	
3521	HMI-SI-3637	Bone Currettes Volkmann 17 cm / 6 6/8"	
3522	HMI-SI-3638	Bone Currettes Volkmann 13 cm / 5 1/8" Ø 6,5 mm	
3523	HMI-SI-3639	Bone Currettes Volkmann 16 cm / 6 2/8" Ø 9,0 mm	
3524	HMI-SI-3640	Bone Currettes Volkmann 20 cm / 7 7/8" Ø 11,0 mm	
3525	HMI-SI-3641	Bone Currettes 21 cm / 8 2/8"	
3526	HMI-SI-3642	Bone Currettes, double-ended, Bone Currettes Williger 14 cm / 5 4/8" oval 2,5 mm	
3527	HMI-SI-3643	Bone Currettes, double-ended, Bone Currettes Williger 14 cm / 5 4/8" oval 3,0 mm	







3528	HMI-SI-3644	Bone Currettes, double-ended, Bone Currettes Williger 14 cm / 5 4/ 8" oval 3,5 mm	
3529	HMI-SI-3645	Bone Currettes, double-ended, Bone Currettes Williger 16,5 cm / 6 4/ 8" 2,5 mm	
3530	HMI-SI-3646	Bone Currettes, double-ended, Bone Currettes Williger 16,5 cm / 6 4/ 8" 3,0 mm	
3531	HMI-SI-3647	Bone Currettes, double-ended, Bone Currettes Williger 16,5 cm / 6 4/ 8" 3,5 mm	
3532	HMI-SI-3648	Bone Currettes, double-ended, Bone Currettes Molt 17 cm / 6 6/ 8"	
3533	HMI-SI-3649	Bone Currettes, double-ended, Bone Currettes Molt 17 cm / 6 6/ 8"	
3534	HMI-SI-3650	Bone Currettes, double-ended, Bone Currettes Molt 17 cm / 6 6/ 8"	
3535	HMI-SI-3651	Bone Currettes, double-ended, Bone Currettes Molt 17 cm / 6 6/ 8"	
3536	HMI-SI-3652	Bone Currettes, double-ended, Bone Currettes Molt 17 cm / 6 6/ 8"	
3537	HMI-SI-3653	Bone Currettes, double-ended, Bone Currettes Molt 19 cm / 7 4/ 8"	
3538	HMI-SI-3654	Periosteal Elevators Martin-Langenbeck solid 19 cm / 7 4/ 8" 16 mm	



3539	HMI-SI-3655	Periosteal Elevators Martin-Langenbeck solid 20 cm / 7 7/8" 16 mm
3540	HMI-SI-3656	Periosteal Elevators Martin-Langenbeck solid 19 cm / 7 4/8" 12 mm
3541	HMI-SI-3657	Periosteal Elevators Martin-Langenbeck solid 18 cm / 7 1/8" 12 mm
3542	HMI-SI-3658	Periosteal Elevators Martin-Hoen solid 16 cm / 6 2/8" 7 mm
3543	HMI-SI-3659	Periosteal Elevators Martin-Hoen solid 18,5 cm / 7 2/8" 15 mm
3544	HMI-SI-3660	Periosteal Elevators Martin-Hoen solid 19 cm / 7 4/8" 20 mm
3545	HMI-SI-3661	Periosteal Elevators Martin-Cushing solid 17,5 cm / 7 " 4 mm
3546	HMI-SI-3662	Periosteal Elevators Martin-Cushing solid 17,5 cm / 7 " 6 mm
3547	HMI-SI-3663	Periosteal Elevators Martin-Cushing solid 19,5 cm / 7 6/8" 5 mm



















3548	HMI-SI-3664	Periosteal Elevators Martin-Cushing solid 19,5 cm / 7 6/8" 7 mm	
3549	HMI-SI-3665	Periosteal Elevators Martin-Cushing solid 17 cm / 6 6/8" 8 mm	
3550	HMI-SI-3666	Periosteal Elevators Langenbeck 18 cm / 7 1/8" with hollow handle 14 mm	
3551	HMI-SI-3667	Periosteal Elevators Langenbeck 19 cm / 7 4/8" with hollow handle 18 mm	
3552	HMI-SI-3668	Periosteal Elevators Landolt 17,5 cm / 6 7/8" 4,5 mm	
3553	HMI-SI-3669	Periosteal Elevators Jansen 16,5 cm / 6 4/8" 15 mm	
3554	HMI-SI-3670	Periosteal Elevators König 5,5 cm / 6 1/8" 5 mm	
3555	HMI-SI-3671	Periosteal Elevators Trelat 15 cm / 5 7/8" 8 mm	

3556	HMI-SI-3672	Periosteal Elevators Schneider 17,5 cm / 6 7/8" 13mm	
3557	HMI-SI-3673	Periosteal Elevators Schneider-Sauerbruch 19 cm / 7 4/8" 13mm	
3558	HMI-SI-3674	Periosteal Elevators 16 cm / 6 2/8" delicate, angled, solid 5 mm	
3559	HMI-SI-3675	Periosteal Elevators 16 cm / 6 2/8" delicate, angled, solid 6 mm	
3560	HMI-SI-3676	Periosteal Elevators 16 cm / 6 2/8" delicate, angled, solid 7 mm	
3561	HMI-SI-3677	Periosteal Elevators Cottle 19 cm / 7 4/8" 9 mm	
3562	HMI-SI-3678	Periosteal Elevators Cottle 20 cm / 7 7/8" 6 mm	
3563	HMI-SI-3679	Periosteal Elevators Sedillot 18,5 cm / 7 2/8" 18 mm	

3564	HMI-SI-3680	Periosteal Elevators Farabeuf-Collin 15,5 cm / 6 1/8" 11 mm	
3565	HMI-SI-3681	Periosteal Elevators Farabeuf-Collin 15,5 cm / 6 1/8" 11 mm	
3566	HMI-SI-3682	Periosteal Elevators Farabeuf 15,5 cm / 6 1/8" with hollow handle 12,5 mm	
3567	HMI-SI-3683	Periosteal Elevators Farabeuf 15,5 cm / 6 1/8" with hollow handle 12,5 mm	
3568	HMI-SI-3684	Periosteal Elevators Muhling 17 cm / 6 6/8" 4 mm	
3569	HMI-SI-3685	Periosteal Elevators Muhling 17 cm / 6 6/8" 4 mm	
3570	HMI-SI-3686	Periosteal Elevators Muhling 17 cm / 6 6/8" 4 mm	
3571	HMI-SI-3687	Periosteal Elevators Muhling 17 cm / 6 6/8" 4 mm	
3572	HMI-SI-3688	Periosteal Elevators Key 18 cm / 7 1/8" 3 mm	



3573	HMI-SI-3689	Periosteal Elevators Key 18 cm / 7 1/8" 6,5 mm	
3574	HMI-SI-3690	Periosteal Elevators Key 19 cm / 7 4/8" 9,5 mm	
3575	HMI-SI-3691	Periosteal Elevators Key 19 cm / 7 4/8" 12,5 mm	
3576	HMI-SI-3692	Periosteal Elevators Key 20 cm / 7 7/8" 16 mm	
3577	HMI-SI-3693	Periosteal Elevators Key 20 cm / 7 7/8" 19 mm	
3578	HMI-SI-3694	Periosteal Elevators Key 21 cm / 8 2/8" 24,5 mm	
3579	HMI-SI-3695	Periosteal Elevators Cobb 23 cm / 9" 6 mm	
3580	HMI-SI-3696	Periosteal Elevators Cobb 23 cm / 9" 10 mm	
3581	HMI-SI-3697	Periosteal Elevators Cobb 23 cm / 9" 13 mm	
3582	HMI-SI-3698	Periosteal Elevators Cobb 23 cm / 9" 19 mm	
3583	HMI-SI-3699	Periosteal Elevators Cobb 23 cm / 9" 25 mm	
3584	HMI-SI-3700	Periosteal Elevators Cobb 28 cm / 11" 6 mm	
3585	HMI-SI-3701	Periosteal Elevators Cobb 28 cm / 11" 10 mm	
3586	HMI-SI-3702	Periosteal Elevators Cobb 28 cm / 11" 13 mm	
3587	HMI-SI-3703	Periosteal Elevators Cobb 28 cm / 11" 19 mm	
3588	HMI-SI-3704	Periosteal Elevators Cobb 28 cm / 11" 25 mm	
3589	HMI-SI-3705	Periosteal Elevators Sedillot 23 cm / 9" 15 mm	
3590	HMI-SI-3706	Periosteal Elevators 20 cm / 7 7/8" 6 mm	
3591	HMI-SI-3707	Periosteal Elevators 20 cm / 7 7/8" 14 mm	



3592	HMI-SI-3708	Periosteal Elevators 20 cm / 7 7/8" 14 mm	
3593	HMI-SI-3709	Periosteal Elevators 20 cm / 7 7/8" 6 mm	
3594	HMI-SI-3710	Periosteal Elevators 20 cm / 7 7/8" 3 mm	
3595	HMI-SI-3711	Periosteal Elevators 20 cm / 7 7/8" 13 mm	
3596	HMI-SI-3712	Periosteal Elevators 20 cm / 7 7/8" 6 mm	
3597	HMI-SI-3713	Periosteal Elevators Williger 12,5 cm / 4 7/8" solid 6 mm	
3598	HMI-SI-3714	Periosteal Elevators Kahre-Williger 16,5 cm / 6 4/8" solid 16,5 cm / 6 4/8" 4 mm	
3599	HMI-SI-3715	Periosteal Elevators Kahre-Williger 16,5 cm / 6 4/8" solid 16,5 cm / 6 4/8" 5 mm	



3600	HMI-SI-3716	Periosteal Elevators Williger 16 cm / 6 4/ 8" solid 7 mm	
3601	HMI-SI-3717	Periosteal Elevators Williger 16 cm / 6 4/ 8" solid 5 mm	
3602	HMI-SI-3718	Periosteal Elevators 20 cm / 7 7/ 8" 19 mm	
3603	HMI-SI-3720	Periosteal Elevators 17 cm / 6 6/ 8" 3 mm	   
3604	HMI-SI-3721	Periosteal Elevators 17 cm / 6 6/ 8" 6 mm	
3605	HMI-SI-3722	Periosteal Elevators 17 cm / 6 6/ 8" with hollow handle 6mm	
3606	HMI-SI-3723	Periosteal Elevators 17 cm / 6 6/ 8" with hollow handle 8mm	
3607	HMI-SI-3724	Periosteal Elevators Doyen Rib Raspatories, with hollow handle 17 cm / 6 6/ 8" right curved for adults	





3608	HMI-SI-3725	Periosteal Elevators Doyen Rib Raspatories, with hollow handle 17 cm / 6 6/8" left curved for adults
3609	HMI-SI-3726	Periosteal Elevators Doyen Rib Raspatories, with hollow handle 18 cm / 7 1/8" right curved for children
3610	HMI-SI-3727	Periosteal Elevators Doyen Rib Raspatories, with hollow handle 18 cm / 7 1/8" left curved for children
3611	HMI-SI-3728	Periosteal Elevators Alexander 21 cm / 8 2/8"
3612	HMI-SI-3729	Periosteal Elevators Semb 19 cm / 7 4/8" 12 mm
3613	HMI-SI-3730	Periosteal Elevators Semb 22 cm / 8 5/8" 12 mm
3614	HMI-SI-3731	Periosteal Elevators Semb 19 cm / 7 4/8" 13 mm
3615	HMI-SI-3732	Periosteal Elevators Semb 22 cm / 8 5/8" 13 mm

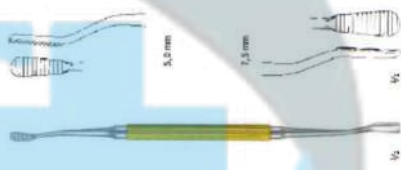
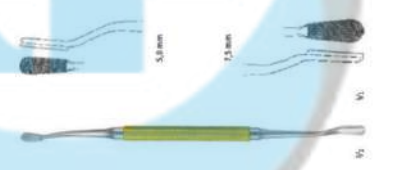
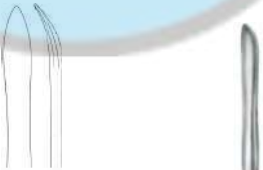



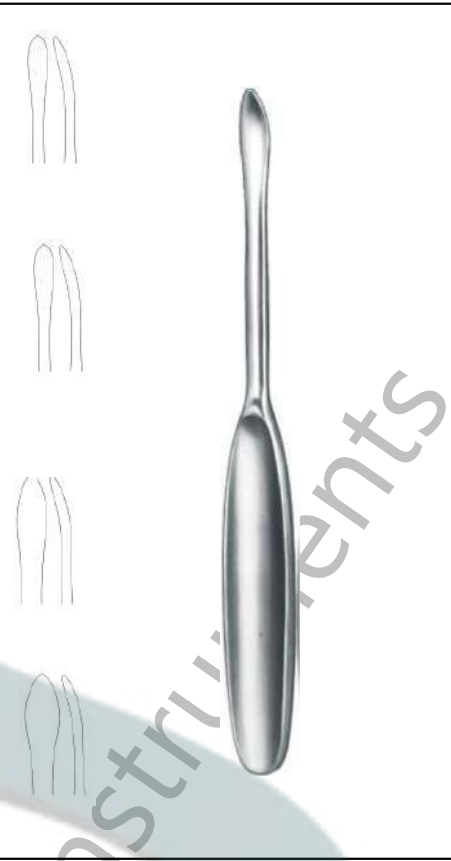
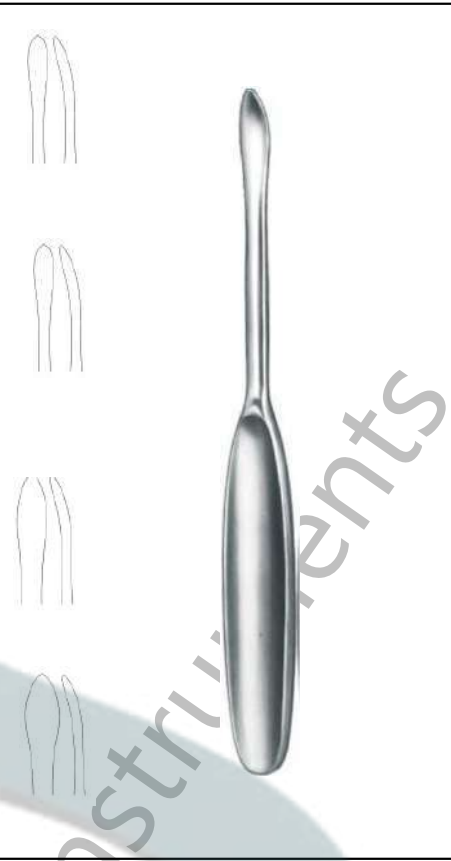





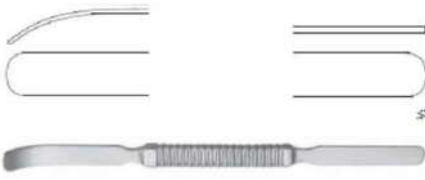

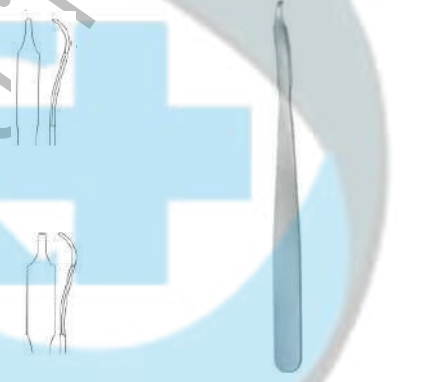



3616	HMI-SI-3733	Periosteal Elevators Semb 23 cm / 9 " 15 mm	
3617	HMI-SI-3734	Periosteal Elevators Lambotte 21,5 cm / 8 4/ 8" 5 mm	
3618	HMI-SI-3735	Periosteal Elevators Lambotte 21,5 cm / 8 4/ 8" 10 mm	
3619	HMI-SI-3736	Periosteal Elevators Lambotte 21,5 cm / 8 4/ 8" 15 mm	
3620	HMI-SI-3737	Periosteal Elevators Lambotte 21,5 cm / 8 4/ 8" 20 mm	
3621	HMI-SI-3738	Periosteal Elevators Lambotte 21,5 cm / 8 4/ 8" 25 mm	
3622	HMI-SI-3739	Bone Files 28 cm / 11 " semi round, with hollow handle	
3623	HMI-SI-3740	Bone Files 25 cm / 9 7/ 8" semi round, with hollow handle	







3624	HMI-SI-3741	Bone Files 22 cm / 8 5/ 8" flat, solid	
3625	HMI-SI-3742	Elevators, Bone Files Adson 17 cm / 6 6/ 8" 7,9 mm	
3626	HMI-SI-3743	Elevators, Bone Files Adson 17,5 cm / 6 7/ 8" 5,0 mm	
3627	HMI-SI-3744	Elevators, Bone Files Adson 17,5 cm / 6 7/ 8" 7,7 mm	
3628	HMI-SI-3745	Elevators, Bone Files Adson 17 cm / 6 6/ 8" 6,3 mm	
3629	HMI-SI-3747	Elevators, Bone Files Miller-Colburn downwards cutting 18 cm / 7 1/ 8" 6,6 mm	
3630	HMI-SI-3748	Elevators, Bone Files Miller-Colburn downwards cutting 18 cm / 7 1/ 8" 6,8 mm	
3631	HMI-SI-3749	Elevators, Bone Files Miller-Colburn downwards cutting 18 cm / 7 1/ 8" 7,0 mm	
3632	HMI-SI-3750	Elevators, Bone Files Miller-Colburn downwards cutting 18 cm / 7 1/ 8" 4,6 mm	
3633	HMI-SI-3751	Elevators, Bone Files Miller-Colburn downwards cutting 18 cm / 7 1/ 8" 7,8 mm	





3634	HMI-SI-3752	Elevators, Bone Files Miller-Colburn cross cut 18 cm / 7 1/ 8" 6,0 mm	
3635	HMI-SI-3753	Elevators, Bone Files Miller-Colburn cross cut 18 cm / 7 1/ 8" 7,2 mm	
3636	HMI-SI-3754	Elevators, Bone Files Miller-Colburn cross cut 18 cm / 7 1/ 8" 6,2 mm	
3637	HMI-SI-3755	Elevators, Bone Files Miller-Colburn cross cut 18 cm / 7 1/ 8" 5,0 mm	
3638	HMI-SI-3756	Elevators, Bone Files TCGOLD Miller 19 cm / 7 4/ 8"	
3639	HMI-SI-3757	Elevators, Bone Files TCGOLD Miller 19 cm / 7 4/ 8"	
3640	HMI-SI-3758	Elevators Langenbeck 19,5 cm / 7 5/ 8" 7 mm	
3641	HMI-SI-3759	Elevators Langenbeck 19,5 cm / 7 5/ 8" 10 mm	







3642	HMI-SI-3760	Elevators Martin-Langenbeck solid 17 cm / 6 6/8" 5 mm	
3643	HMI-SI-3761	Elevators Martin-Langenbeck solid 17 cm / 6 6/8" 7 mm	
3644	HMI-SI-3762	Elevators Martin-Langenbeck solid 19,5 cm / 7 5/8" 8 mm	
3645	HMI-SI-3763	Elevators Martin-Langenbeck solid 19,5 cm / 7 5/8" 10 mm	
3646	HMI-SI-3764	Elevators Williger 17 cm / 6 6/8" Solid 7 mm	
3647	HMI-SI-3765	Elevators Williger 16 cm / 6 2/8" 4 mm	
3648	HMI-SI-3766	Elevators Sebileau 17,5 cm / 6 7/8" 5 mm	
3649	HMI-SI-3767	Elevators Quervain 19,5 cm / 7 5/8" 6 mm	





3650	HMI-SI-3768	Elevators Alderdyce 21 cm / 8 2/8"	
3651	HMI-SI-3769	Elevators 18 cm / 7 1/8"	
3652	HMI-SI-3770	Elevators McDonald 18,5 cm / 7 2/8" 5,3 mm	
3653	HMI-SI-3771	Bone Levers 15 cm / 5 7/8" 6 mm	
3654	HMI-SI-3772	Bone Levers Hohmann, mini 16 cm / 6 2/8" 6 mm	
3655	HMI-SI-3773	Bone Levers Hohmann, mini 16 cm / 6 2/8" 8 mm	
3656	HMI-SI-3774	Bone Levers 16 cm / 6 2/8" 15 mm	
3657	HMI-SI-3775	Bone Levers 12 cm / 4 6/8" 15 mm	





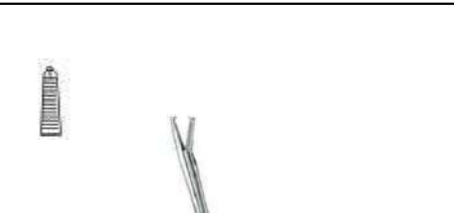

3658	HMI-SI-3776	Bone Levers Hohmann 21,5 cm / 8 4/ 8" narrow tip 8 mm	
3659	HMI-SI-3777	Bone Levers Hohmann 23,5 cm / 9 2/ 8" 18 mm	
3660	HMI-SI-3778	Bone Levers Hohmann 21,5 cm / 8 4/ 8" narrow tip 43 mm	
3661	HMI-SI-3779	Bone Levers Hohmann 25 cm / 9 7/ 8" narrow tip 70 mm	
3662	HMI-SI-3780	Bone Levers Hohmann 23,5 cm / 9 2/ 8" narrow tip 43 mm	
3663	HMI-SI-3781	Bone Levers Hohmann 25,5 cm / 10 " wide tip 22 mm	
3664	HMI-SI-3782	Bone Levers Hohmann 29 cm / 11 3/ 8" wide tip 35 mm	
3665	HMI-SI-3783	Bone Levers Hohmann 27,5 cm / 10 7/ 8" wide, round tip 24 mm	

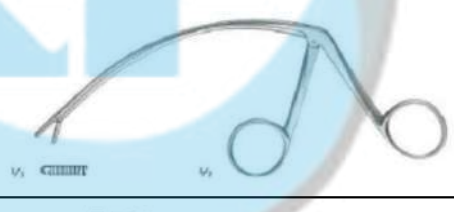
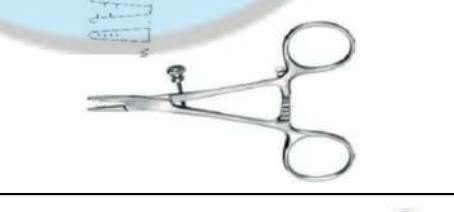
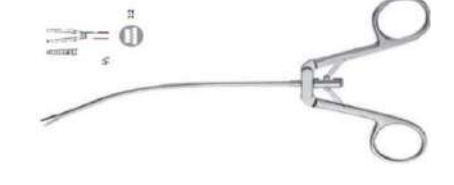

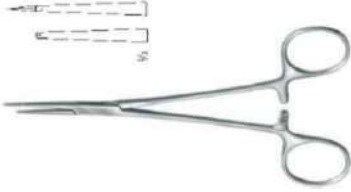

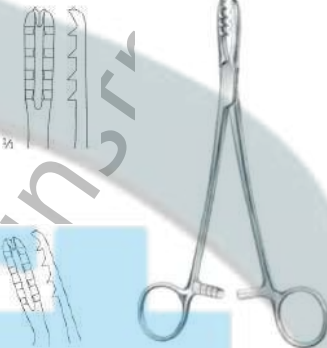
3666	HMI-SI-3784	Bone Levers Lange-Hohmann 25 cm / 9 7/8" wide tip with groove 22 mm	
3667	HMI-SI-3786	Bone Levers Bennett 24 cm / 9 4/8" 43 mm	
3668	HMI-SI-3787	Bone Levers Bennett 23,5 cm / 9 2/8" 60 mm	
3669	HMI-SI-3788	Knee Retractors, Spinal Retractors Blount 26,5 cm / 10 3/8" blunt 39 mm	
3670	HMI-SI-3789	Knee Retractors, Spinal Retractors Blount 26,5 cm / 10 3/8" 47 mm	
3671	HMI-SI-3790	Knee Retractors, Spinal Retractors Blount 17,5 cm / 6 7/8"	
3672	HMI-SI-3791	Knee Retractors, Spinal Retractors Taylor 16 cm / 6 2/8" 95 x 30 mm	
3673	HMI-SI-3792	Knee Retractors, Spinal Retractors Taylor 16 cm / 6 2/8" 115 x 30 mm	

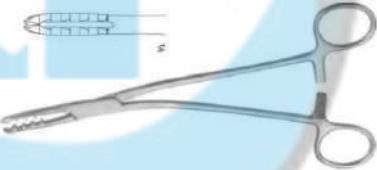



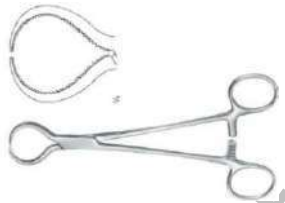
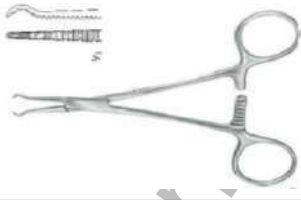

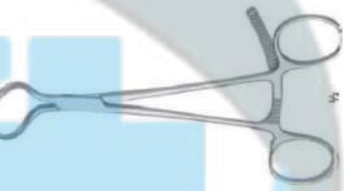
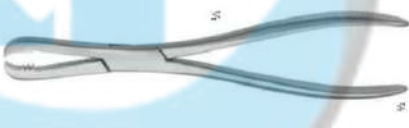

3674	HMI-SI-3793	Meniscus Knives 17,5 cm / 6 7/8"	
3675	HMI-SI-3794	Meniscus Knives 17,5 cm / 6 7/8"	
3676	HMI-SI-3795	Meniscus Knives 17,5 cm / 6 7/8"	
3677	HMI-SI-3796	Meniscus Knives Neff 22 cm / 8 5/8"	
3678	HMI-SI-3797	Meniscus Knives Neff 22 cm / 8 5/8"	
3679	HMI-SI-3798	Meniscus Knives Salenius 21,5 cm / 8 4/8"	
3680	HMI-SI-3799	Meniscus Knives Salenius 21,5 cm / 8 4/8"	
3681	HMI-SI-3800	Tendon Strippers Bunnell 15 cm / 5 7/8" Ø 4,5 mm	
3682	HMI-SI-3801	Tendon Strippers Bunnell 15 cm / 5 7/8" Ø 5,5 mm	
3683	HMI-SI-3802	Tendon Strippers Bunnell 15 cm / 5 7/8" Ø 6,5 mm	
3684	HMI-SI-3803	Tendon Strippers Bunnell 15 cm / 5 7/8" Ø 7,5 mm	





3685	HMI-SI-3804	Tendon Strippers Bunnell 15 cm / 5 7/8" Ø 8,5 mm	
3686	HMI-SI-3805	Tendon Strippers 23 cm / 9" flexible shaft Ø 4 mm	
3687	HMI-SI-3806	Tendon Strippers 23 cm / 9" flexible shaft Ø 4,5 mm	
3688	HMI-SI-3807	Tendon Strippers 23 cm / 9" flexible shaft Ø 5,5 mm	
3689	HMI-SI-3808	Tendon Strippers 33,5 cm / 13 2/8" Tendon Passing Instrument	
3690	HMI-SI-3809	Tendon Strippers 33,5 cm / 13 2/8" Tendon Passing Instrument Screw	
3691	HMI-SI-3810	Tendon Strippers 28,5 cm / 11 2/8"	
3692	HMI-SI-3811	Tendon Strippers Bunnell 23 cm / 9" Tendon Passer malleable	
3693	HMI-SI-3812	Tendon Holding Forceps, Tendon Tunnelling Forceps Steinmann 16 cm / 6 2/8"	



3694	HMI-SI-3813	Tendon Holding Forceps, Tendon Tunnelling Forceps Brand 15 cm / 5 7/8"	
3695	HMI-SI-3814	Tendon Holding Forceps, Tendon Tunnelling Forceps Brand 19 cm / 7 4/8"	
3696	HMI-SI-3815	Tendon Holding Forceps, Tendon Tunnelling Forceps Brand 24,5 cm / 9 5/8"	
3697	HMI-SI-3816	Tendon Holding Forceps, Tendon Tunnelling Forceps 21 cm / 8 2/8"	
3698	HMI-SI-3817	Tendon Holding Forceps, Tendon Tunnelling Forceps 20,5 cm / 8 1/8"	
3699	HMI-SI-3818	Tendon Holding Forceps, Tendon Tunnelling Forceps Carroll 11,5 cm / 4 4/8"	
3700	HMI-SI-3819	Tendon Holding Forceps, Tendon Interlacing Forceps 11,5 cm / 4 4/8"	
3701	HMI-SI-3820	Tendon Holding Forceps, Tendon Interlacing Forceps Kleinert-Kutz 21 cm / 8 2/8" shaft length	





3702	HMI-SI-3821	Tendon Holding Forceps, Tendon Interlacing Forceps 15 cm / 5 7/8"	
3703	HMI-SI-3822	Tendon Holding Forceps, Tendon Interlacing Forceps 15 cm / 5 7/8"	
3704	HMI-SI-3823	Cartilage Seizing Forceps, Bone Holding Forceps 14,5 cm / 5 6/8" Bone Holding Forceps	
3705	HMI-SI-3824	Cartilage Seizing Forceps, Bone Holding Forceps Bircher-Ganske 21 cm / 8 2/8" straight	
3706	HMI-SI-3825	Cartilage Seizing Forceps, Bone Holding Forceps Bircher-Ganske 20,5 cm / 8 1/8" curved upwards	
3707	HMI-SI-3827	Cartilage Seizing Forceps, Bone Holding Forceps Bircher-Ganske 20 cm / 7 7/8" curved sideways	
3708	HMI-SI-3828	Cartilage Seizing Forceps, Bone Holding Forceps Dingmann 18,5 cm / 7 2/8"	
3709	HMI-SI-3829	Cartilage Seizing Forceps, Reposition Forceps, Bone Holding Forceps Martin 18,5 cm / 7 2/8"	

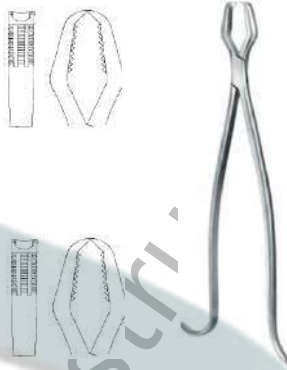

3710	HMI-SI-3830	Cartilage Seizing Forceps, Reposition Forceps, Bone Holding Forceps 13,5 cm / 5 3/8" long ratchet	
3711	HMI-SI-3831	Cartilage Seizing Forceps, Reposition Forceps, Bone Holding Forceps Lewin 18 cm / 7 1/8"	
3712	HMI-SI-3832	Cartilage Seizing Forceps, Reposition Forceps, Bone Holding Forceps 14 cm / 5 4/8" delicate	
3713	HMI-SI-3833	Cartilage Seizing Forceps, Reposition Forceps, Bone Holding Forceps 9 cm / 3 4/8" long ratchet	
3714	HMI-SI-3834	Cartilage Seizing Forceps, Reposition Forceps, Bone Holding Forceps 15 cm / 5 7/8" long ratchet	
3715	HMI-SI-3835	Bone Holding Forceps Langenbeck 21 cm / 8 2/8"	
3716	HMI-SI-3836	Bone Holding Forceps Fergusson 21 cm / 8 2/8" heavy pattern	
3717	HMI-SI-3837	Bone Holding Forceps Frosch 18 cm / 7 1/8"	

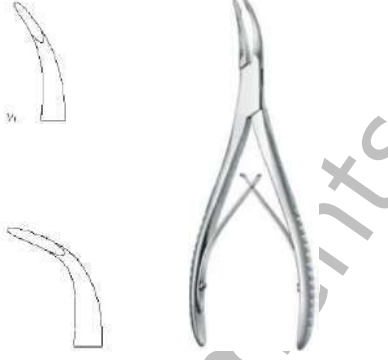
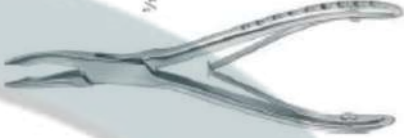

3718	HMI-SI-3838	Bone Holding Forceps 20 cm / 7 7/8"	
3719	HMI-SI-3839	Bone Holding Forceps 17,5 cm / 6 7/8" with thread fixation	
3720	HMI-SI-3840	Bone Holding Forceps 24 cm / 9 4/8" with thread fixation	
3721	HMI-SI-3841	Bone Holding Forceps, Reposition Forceps Kern 17 cm / 6 6/8"	
3722	HMI-SI-3842	Bone Holding Forceps, Reposition Forceps Kern 24,5 cm / 9 5/8"	
3723	HMI-SI-3843	Bone Holding Forceps, Reposition Forceps Semb 19,5 cm / 7 5/8" curved sideways	
3724	HMI-SI-3844	Bone Holding Forceps Farabeuf 23 cm / 9"	
3725	HMI-SI-3845	Bone Holding Forceps Farabeuf 26 cm / 10 2/8"	





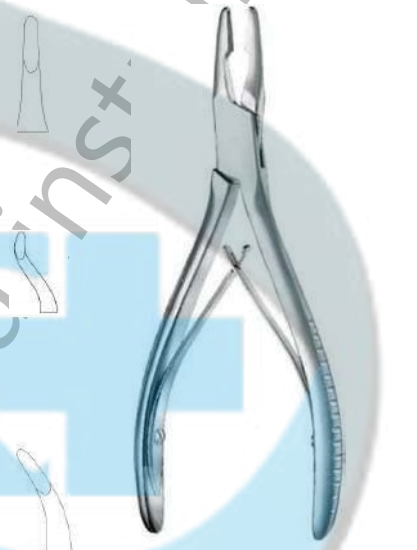
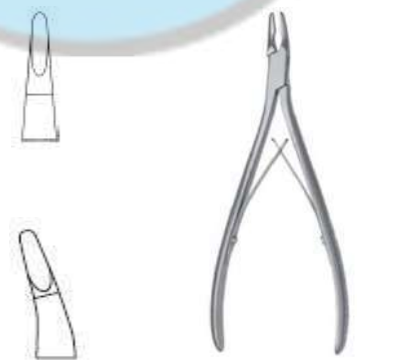

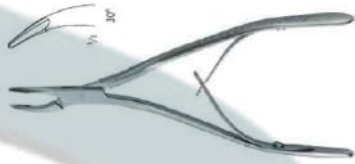
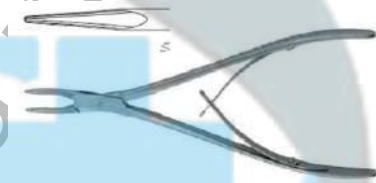
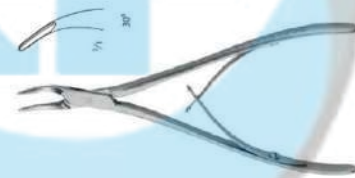
3726	HMI-SI-3846	Bone Holding Forceps Farabeuf 26 cm / 10 2/8"	
3727	HMI-SI-3847	Bone Holding Forceps Ulrich with thread fixation 23 cm / 9 "	
3728	HMI-SI-3848	Bone Holding Forceps Ulrich with thread fixation 25 cm / 9 7/8"	
3729	HMI-SI-3849	Bone Holding Forceps Ulrich with thread fixation 28 cm / 11 "	
3730	HMI-SI-3850	Bone Holding Forceps Ulrich with thread fixation 23 cm / 9 "	
3731	HMI-SI-3851	Bone Holding Forceps Ulrich with thread fixation 25 cm / 9 7/8"	
3732	HMI-SI-3852	Bone Holding Forceps Ulrich with thread fixation 27 cm / 10 5/8"	
3733	HMI-SI-3853	Bone Holding Forceps self-centering, with thread fixation 15 cm / 5 7/8"	
3734	HMI-SI-3854	Bone Holding Forceps self-centering, with thread fixation 20 cm / 7 7/8"	









3735	HMI-SI-3855	Bone Holding Forceps self-centering, with thread fixation 24 cm / 9 4/8"	
3736	HMI-SI-3856	Bone Holding Forceps self-centering, with thread fixation 26 cm / 10 2/8"	
3737	HMI-SI-3857	Bone Holding Forceps self-centering, with thread fixation 28 cm / 11 "	
3738	HMI-SI-3858	Bone Holding Forceps self-centering, with thread fixation Knurled nut	
3739	HMI-SI-3859	Bone Holding Forceps Lane without ratchet 33 cm / 13 "	
3740	HMI-SI-3860	Bone Holding Forceps Lane with ratchet 33 cm / 13 "	
3741	HMI-SI-3861	Bone Holding Forceps Verbrugge 25 cm / 9 7/8"	
3742	HMI-SI-3862	Bone Holding Forceps Verbrugge 26 cm / 10 2/8"	
3743	HMI-SI-3863	Bone Holding Forceps Verbrugge 27,5 cm / 10 7/8"	
3744	HMI-SI-3864	Bone Holding Forceps, Amputation Retractor Verbrugge 17,5 cm / 6 7/8"	







3745	HMI-SI-3865	Bone Holding Forceps, Amputation Retractor Percy detachable	
3746	HMI-SI-3866(a)	Bone Rongeurs Stellbrink 17 cm / 6 6/8"	
3747	HMI-SI-3866(b)	Bone Rongeurs Stellbrink 16,5 cm / 6 4/8"	
3748	HMI-SI-3867	Bone Rongeurs Friedmann 12,5 cm / 4 7/8"	
3749	HMI-SI-3867(a)	Bone Rongeurs Friedmann 13,5 cm / 5 3/8"	
3750	HMI-SI-3868	Bone Rongeurs Friedmann 13,5 cm / 5 3/8"	
3751	HMI-SI-3869	Bone Rongeurs Cleveland 13,5 cm / 5 3/8"	
3752	HMI-SI-3870	Bone Rongeurs Cleveland 16,5 cm / 6 4/8"	



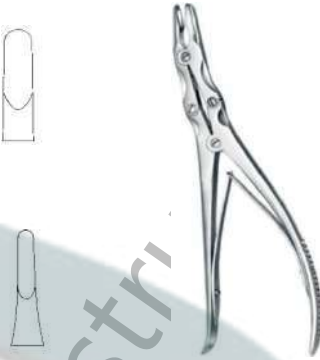

3753	HMI-SI-3871	Bone Rongeurs Mead 16,5 cm / 6 4/8"	
3754	HMI-SI-3872	Bone Rongeurs Mead 16,5 cm / 6 4/8"	
3755	HMI-SI-3873	Bone Rongeurs Hartmann 17,5 cm / 6 7/8"	
3756	HMI-SI-3874	Bone Rongeurs Jansen 18 cm / 7 1/8"	
3757	HMI-SI-3875	Bone Rongeurs Jansen 18,5 cm / 7 2/8"	
3758	HMI-SI-3876	Bone Rongeurs Jansen 18 cm / 7 1/8"	
3759	HMI-SI-3877	Bone Rongeurs Lempert 19 cm / 7 4/8"	
3760	HMI-SI-3878	Bone Rongeurs Lempert 19 cm / 7 4/8"	

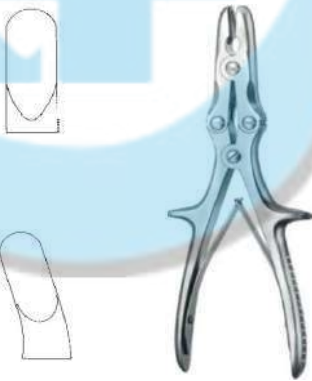



3761	HMI-SI-3879	Bone Rongeurs Blumenthal 16 cm / 6 2/8"	
3762	HMI-SI-3880	Bone Rongeurs Blumenthal 15,5 cm / 6 1/8"	
3763	HMI-SI-3881	Bone Rongeurs Blumenthal 15 cm / 5 7/8"	
3764	HMI-SI-3882	Bone Rongeurs 15,5 cm / 6 1/8" S-shape	
3765	HMI-SI-3883	Bone Rongeurs 15,5 cm / 6 1/8"	
3766	HMI-SI-3884	Bone Rongeurs 15,5 cm / 6 1/8" 30°	
3767	HMI-SI-3885	Bone Rongeurs 14,5 cm / 5 6/8" 90°	
3768	HMI-SI-3886	Bone Rongeurs Luer 18,5 cm / 7 2/8"	

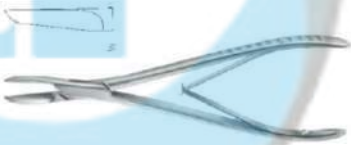







3769	HMI-SI-3887	Bone Rongeurs Luer 18,5 cm / 7 2/8"	
3770	HMI-SI-3888	Bone Rongeurs Luer 14,5 cm / 5 6/8"	
3771	HMI-SI-3889	Bone Rongeurs Luer 14,5 cm / 5 6/8"	
3772	HMI-SI-3890	Bone Rongeurs Luer 14,5 cm / 5 6/8"	
3773	HMI-SI-3891	Bone Rongeurs Böhler 15 cm / 5 7/8"	
3774	HMI-SI-3892	Bone Rongeurs Böhler 15 cm / 5 7/8"	
3775	HMI-SI-3893	Bone Rongeurs Beyer 18 cm / 7 1/8"	
3776	HMI-SI-3894	Bone Rongeurs Zaufal-Jansen 18 cm / 7 1/8"	









3777	HMI-SI-3895	Bone Rongeurs Mayyeld 18 cm / 7 1/8"	
3778	HMI-SI-3896	Bone Rongeurs Marquard 20,5 cm / 8 1/8"	
3779	HMI-SI-3897	Bone Rongeurs Ruskin 19 cm / 7 4/8"	
3780	HMI-SI-3898	Bone Rongeurs Ruskin 24 cm / 9 4/8"	
3781	HMI-SI-3899	Bone Rongeurs Semb 23,5 cm / 9 2/8"	
3782	HMI-SI-3900	Bone Rongeurs Stille 22,5 cm / 8 7/8"	
3783	HMI-SI-3901	Bone Rongeurs Echlin 23 cm / 9 "	
3784	HMI-SI-3902	Bone Rongeurs Echlin 23 cm / 9 "	





3785	HMI-SI-3903	Bone Rongeurs Echlin 23 cm / 9 "	
3786	HMI-SI-3904	Bone Rongeurs Stille-Ruskin 23,5 cm / 9 2/8"	
3787	HMI-SI-3905	Bone Rongeurs Leksell-Stille 24,5 cm / 9 5/8"	
3788	HMI-SI-3906	Bone Rongeurs Leksell-Stille 24,5 cm / 9 5/8"	
3789	HMI-SI-3907	Bone Rongeurs Frykholm 24,5 cm / 9 5/8"	
3790	HMI-SI-3908	Bone Rongeurs Stille-Luer 22,5 cm / 8 7/8"	
3791	HMI-SI-3909	Bone Rongeurs Stille-Luer 22,5 cm / 8 7/8"	
3792	HMI-SI-3910	Bone Rongeurs Stille-Luer 23 cm / 9 "	





3793	HMI-SI-3911	Bone Rongeurs Stille-Luer 23 cm / 9 "	
3794	HMI-SI-3912	Bone Rongeurs Stille-Luer 27 cm / 10 5/8"	
3795	HMI-SI-3913	Bone Rongeurs Stille-Luer 27 cm / 10 5/8"	
3796	HMI-SI-3914	Bone Rongeurs Sauerbruch 31 cm / 12 2/8"	
3797	HMI-SI-3915	Bone Rongeurs Sauerbruch 31 cm / 12 2/8"	
3798	HMI-SI-3916	Bone Cutting Forceps Cottle-Kazanjian 19 cm / 7 4/8"	
3799	HMI-SI-3917	Bone Cutting Forceps Liston 14 cm / 5 4/8"	
3800	HMI-SI-3918	Bone Cutting Forceps Liston 17 cm / 6 6/8"	





3801	HMI-SI-3919	Bone Cutting Forceps Liston 20 cm / 7 7/8"	
3802	HMI-SI-3920	Bone Cutting Forceps Liston 22 cm / 8 5/8"	
3803	HMI-SI-3921	Bone Cutting Forceps Liston 14 cm / 5 4/8"	
3804	HMI-SI-3922	Bone Cutting Forceps Liston 17 cm / 6 6/8"	
3805	HMI-SI-3923	Bone Cutting Forceps Liston 20 cm / 7 7/8"	
3806	HMI-SI-3924	Bone Cutting Forceps Liston 22 cm / 8 5/8"	
3807	HMI-SI-3925	Bone Cutting Forceps Cleveland 17 cm / 6 6/8"	
3808	HMI-SI-3926	Bone Cutting Forceps Cleveland 14,5 cm / 5 6/8"	





3809	HMI-SI-3927	Bone Cutting Forceps Böhler 14,5 cm / 5 6/8"	
3810	HMI-SI-3928	Bone Cutting Forceps Böhler 14,5 cm / 5 6/8"	
3811	HMI-SI-3929	Bone Cutting Forceps Cleveland 17 cm / 6 6/8"	
3812	HMI-SI-3930	Bone Cutting Forceps Ruskin-Liston 19 cm / 7 4/8"	
3813	HMI-SI-3931	Bone Cutting Forceps Ruskin-Liston 18,5 cm / 7 2/8"	
3814	HMI-SI-3932	Bone Cutting Forceps Stille-Liston 26 cm / 10 2/8"	
3815	HMI-SI-3933	Bone Cutting Forceps Stille-Liston 28 cm / 11 "	
3816	HMI-SI-3934	Bone Cutting Forceps Stille-Liston 23,5 cm / 10 2/8"	





3817	HMI-SI-3935	Bone Cutting Forceps Stille-Liston 28 cm / 11 "	
3818	HMI-SI-3936	Bone Cutting Forceps Liston-Key 26 cm / 10 2/8"	
3819	HMI-SI-3937	Bone Cutting Forceps Semb 24,5 cm / 9 5/8"	
3820	HMI-SI-3938	Rib Shears 23 cm / 9" Bone Shears	
3821	HMI-SI-3939	Rib Shears 23 cm / 9"	
3822	HMI-SI-3940	Rib Shears Gluck 21 cm / 8 2/8" drawing cut	
3823	HMI-SI-3941	Rib Shears Bethune 34,5 cm / 13 5/8"	
3824	HMI-SI-3942	Rib Shears Sauerbruch 26 cm / 10 2/8"	

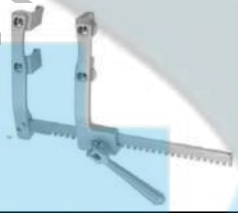







3825	HMI-SI-3943	Rib Shears Giertz-Stille 24,5 cm / 9 5/8"	
3826	HMI-SI-3944	Rib Shears, Sternum Chisel Brunner for right hand	
3827	HMI-SI-3945	Rib Shears, Sternum Chisel Brunner for left hand	
3828	HMI-SI-3946	Rib Shears, Sternum Chisel Lebsche 24,5 cm / 9 5/8"	
3829	HMI-SI-3947	Aortic Punches, Chest Tube Passer 15 cm / 5 7/8" Aortic punches Ø 3,0 mm	
3830	HMI-SI-3948	Aortic Punches, Chest Tube Passer 15 cm / 5 7/8" Aortic punches Ø 3,5 mm	
3831	HMI-SI-3949	Aortic Punches, Chest Tube Passer 15 cm / 5 7/8" Aortic punches Ø 4,0 mm	
3832	HMI-SI-3950	Aortic Punches, Chest Tube Passer 15 cm / 5 7/8" Aortic punches Ø 4,5 mm	
3833	HMI-SI-3951	Aortic Punches, Chest Tube Passer 15 cm / 5 7/8" Aortic punches Ø 5,0 mm	
3834	HMI-SI-3952	Aortic Punches, Chest Tube Passer 15 cm / 5 7/8" Aortic punches Ø 6,0 mm	
3835	HMI-SI-3953	Aortic Punches, Chest Tube Passer w/o ratchet 24 cm / 9 4/8"	
3836	HMI-SI-3954	Aortic Punches, Chest Tube Passer with ratchet 24 cm / 9 4/8"	







3837	HMI-SI-3955	Aortic Punches, Chest Tube Passer w/o ratchet 34 cm / 13 3/8"	
3838	HMI-SI-3956	Aortic Punches, Chest Tube Passer with ratchet 34 cm / 13 3/8"	
3839	HMI-SI-3957	Sternum and Rib Retractors 9 x 20 mm	
3840	HMI-SI-3958	Sternum and Rib Retractors 9 x 10 mm	
3841	HMI-SI-3958(a)	Sternum and Rib Retractors consisting of 2 pairs of blades (24-159-02-09/-03-09) and frame	
3842	HMI-SI-3958(b)	Sternum and Rib Retractors consisting of 2 pairs of blades (24-159-02-09/-03-09) and frame	
3843	HMI-SI-3958(c)	Sternum and Rib Retractors consisting of 2 pairs of blades (24-159-02-09/-03-09) and frame	
3844	HMI-SI-3959	Sternum and Rib Retractors Cooley for babies	
3845	HMI-SI-3960	Sternum and Rib Retractors Cooley for children	
3846	HMI-SI-3961	Sternum and Rib Retractors Cooley for children	
3847	HMI-SI-3962	Sternum and Rib Retractors Cooley for adult	
3848	HMI-SI-3963	Sternum and Rib Retractors Cooley for adult	
3849	HMI-SI-3964	Sternum and Rib Retractors Cooley for adult	
3850	HMI-SI-3965	Sternum and Rib Retractors Finochietto for babies	





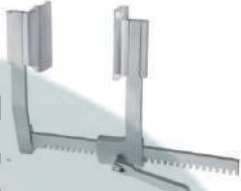



3851	HMI-SI-3966	Sternum and Rib Retractors Finochietto for children	
3852	HMI-SI-3967	Sternum and Rib Retractors Finochietto for children and adults	
3853	HMI-SI-3968	Sternum and Rib Retractors Finochietto for children and adults	
3854	HMI-SI-3969	Sternum and Rib Retractors Finochietto for children and adults	
3855	HMI-SI-3970	Sternum and Rib Retractors Burford for adults	
3856	HMI-SI-3971	Sternum and Rib Retractors Burford for adults	
3857	HMI-SI-3972	Sternum and Rib Retractors Burford for adults	
3858	HMI-SI-3973	Sternum and Rib Retractors Castañeda for babies	



3859	HMI-SI-3974	Sternum and Rib Retractors Castañeda for babies and children	
3860	HMI-SI-3975	Sternum and Rib Retractors Castañeda for children	
3861	HMI-SI-3976	Sternum and Rib Retractors Finochietto (modif.) for children and adults	
3862	HMI-SI-3977	Sternum and Rib Retractors Haight for children and adults	
3863	HMI-SI-3978	Sternum and Rib Retractors Morse-Favaloro for children and adults	
3864	HMI-SI-3979	Sternum and Rib Retractors Morse for adults	
3865	HMI-SI-3980	Sternum and Rib Retractors Morse for adults	
3866	HMI-SI-3981	Sternum and Rib Retractors Tu,er for adults	

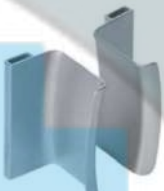



3867	HMI-SI-3982	Sternum and Rib Retractors Finochietto, Baby for babies and children	
3868	HMI-SI-3983	Sternum and Rib Retractors Finochietto for adults	
3869	HMI-SI-3984	Sternum and Rib Retractors Finochietto for adults	
3870	HMI-SI-3985	Sternum and Rib Retractors Finochietto for adults	
3871	HMI-SI-3986	Sternum and Rib Retractors De Bakey for adults consisting of 3 pairs of blades	
3872	HMI-SI-3987	Sternum and Rib Retractors De Bakey for adults consisting of 3 pairs of blades 30 x 30 mm	
3873	HMI-SI-3988	Sternum and Rib Retractors De Bakey for adults consisting of 3 pairs of blades 40 x 40 mm	
3874	HMI-SI-3989	Sternum and Rib Retractors De Bakey for adults consisting of Frame 50 x 50 mm	





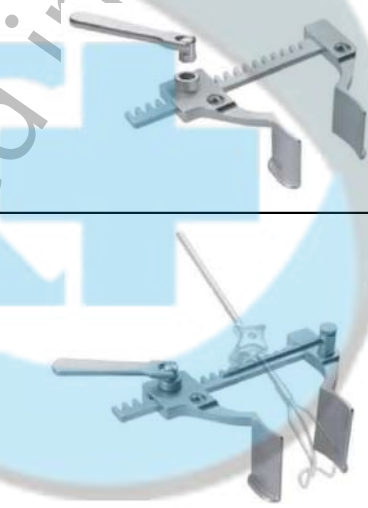

3875	HMI-SI-3990	Sternum and Rib Retractors De Bakey for adults consisting of Frame	
3876	HMI-SI-3991	Sternum and Rib Retractors De Bakey for adults consisting of blade 60 x 60 mm	
3877	HMI-SI-3992	Sternum and Rib Retractors De Bakey for adults consisting of blade 50 x 80 mm	
3878	HMI-SI-3993	Sternum and Rib Retractors De Bakey for adults consisting of blade 40 x 100 mm	
3879	HMI-SI-3994	Sternum and Rib Retractors De Bakey for adults consisting of blade 80 x 60 mm	
3880	HMI-SI-3995	Sternum and Rib Retractors De Bakey for adults consisting of blade 50 x 65 mm	
3881	HMI-SI-3996	Sternum and Rib Retractors De Bakey for adults	
3882	HMI-SI-3997	Sternum and Rib Retractors De Bakey for adults consisting of 3 pairs of blades 30 x 30 mm	









3883	HMI-SI-3998	Sternum and Rib Retractors De Bakey for adults consisting of 3 pairs of blades 40 x 40 mm	
3884	HMI-SI-3999	Sternum and Rib Retractors De Bakey for adults consisting of 3 pairs of blades 50 x 50 mm	
3885	HMI-SI-3999(a)	Sternum and Rib Retractors De Bakey for adults consisting of frame	
3886	HMI-SI-4000	Sternum and Rib Retractors De Bakey for adults consisting of frame	
3887	HMI-SI-4001	Sternum and Rib Retractors De Bakey for adults consisting of 3 pairs of blades 60 x 60 mm	
3888	HMI-SI-4002	Sternum and Rib Retractors De Bakey for adults consisting of 3 pairs of blades 50 x 80 mm	
3889	HMI-SI-4003	Sternum and Rib Retractors De Bakey for adults consisting of 3 pairs of blades 40 x 100 mm	
3890	HMI-SI-4004	Sternum and Rib Retractors De Bakey for adults consisting of 3 pairs of blades 80 x 60 mm	





3891	HMI-SI-4005	Sternum and Rib Retractors De Bakey for adults consisting of 3 pairs of blades 50 x 65 mm	
3892	HMI-SI-4006	Sternum and Rib Retractors Dubost for adults	
3893	HMI-SI-4007	Sternum and Rib Retractors Dubost for adults consisting of 3 pairs of blades 30 x 100 mm	
3894	HMI-SI-4008	Sternum and Rib Retractors Dubost for adults consisting of 3 pairs of blades 40 x 100 mm	
3895	HMI-SI-4009	Sternum and Rib Retractors Dubost for adults consisting of 3 pairs of blades 50 x 100 mm	
3896	HMI-SI-4010	Sternum and Rib Retractors Dubost for adults consisting of IMA blades for IMA configuration	
3897	HMI-SI-4011	Sternum and Rib Retractors Dubost for adults consisting of IMA blades for IMA configuration	
3898	HMI-SI-4012	Sternum and Rib Retractors Dubost for adults consisting of frame	





3899	HMI-SI-4013	Sternum and Rib Retractors IMA retractor for adults	
3900	HMI-SI-4014	Sternum and Rib Retractors Mini thoracotomy retractor with adjustable, jointed arms and detachable bar for adults	
3901	HMI-SI-4014(a)	Sternum and Rib Retractors Mini thoracotomy retractor with adjustable, jointed arms and detachable bar for adults consisting of 2 pairs of blades	
3902	HMI-SI-4014(b)	Sternum and Rib Retractors Mini thoracotomy retractor with adjustable, jointed arms and detachable bar for adults consisting of 2 pairs of blades	
3903	HMI-SI-4014©	Sternum and Rib Retractors Mini thoracotomy retractor with adjustable, jointed arms and detachable bar for adults consisting of Frame with bar	
3904	HMI-SI-4014(d)	Sternum and Rib Retractors Mini thoracotomy retractor with adjustable, jointed arms and detachable bar for adults consisting of Frame with detachable bar	
3905	HMI-SI-4014(e)	Sternum and Rib Retractors Mini thoracotomy retractor with adjustable, jointed arms and detachable bar for adults consisting of 1 pairs of blades	
3906	HMI-SI-4014(f)	Sternum and Rib Retractors Mini thoracotomy retractor with adjustable, jointed arms and detachable bar for adults consisting of Fixation element	









3907	HMI-SI-4014(g)	Sternum and Rib Retractors Mini thoracotomy retractor with adjustable, jointed arms and detachable bar for adults consisting of Retractor	
3908	HMI-SI-4015	Sternum and Rib Retractors Mini thoracotomy retractor with adjustable, jointed arms consisting of frame	
3909	HMI-SI-4016	Sternum and Rib Retractors Mini thoracotomy retractor with adjustable, jointed arms consisting of 2 pairs of blades 40 x 36 mm	
3910	HMI-SI-4017	Sternum and Rib Retractors Mini thoracotomy retractor with adjustable, jointed arms consisting of 2 pairs of blades 55 x 36 mm	
3911	HMI-SI-4018	Sternum and Rib Retractors Mini thoracotomy retractor	
3912	HMI-SI-4019	Sternum and Rib Retractors Mini thoracotomy retractor	
3913	HMI-SI-4020	Sternum and Rib Retractors Mini thoracotomy retractor	
3914	HMI-SI-4021	Sternum and Rib Retractors Mini thoracotomy retractor with detachable cross-bar	
3915	HMI-SI-4022	Sternum and Rib Retractors Mini thoracotomy retractor with detachable cross-bar	
3916	HMI-SI-4023	Sternum and Rib Retractors Mini thoracotomy retractor with detachable cross-bar	
3917	HMI-SI-4024	Sternum and Rib Retractors Forceps for blade replacement	



3918	HMI-SI-4025	Sternum and Rib Retractors Cross-bar	
3919	HMI-SI-4026	Sternum and Rib Retractors Fixation element	
3920	HMI-SI-4027	Sternum and Rib Retractors Retractor, malleable	
3921	HMI-SI-4028	Sternum and Rib Retractors Cooley Retractor 35 x 25 mm	
3922	HMI-SI-4029	Sternum and Rib Retractors Cooley Retractor 40 x 36 mm	
3923	HMI-SI-4030	Sternum and Rib Retractors Cooley Retractor 50 x 36 mm	
3924	HMI-SI-4031	Sternum and Rib Retractors French IMA configuration Frame	
3925	HMI-SI-4032	Sternum and Rib Retractors French IMA consisting of 3 blades 30 x 100 mm blade, french	





3926	HMI-SI-4033	Sternum and Rib Retractors French IMA consisting of 3 blades 50 x 22 mm blade, french	
3927	HMI-SI-4034	Sternum and Rib Retractors French IMA consisting of 3 blades 40 x 22 mm blade, french	
3928	HMI-SI-4035	Sternum and Rib Retractors Exposure, stability and flexibility Perfection for valve and bypass surgery	
3929	HMI-SI-4036	Sternum and Rib Retractors Exposure, stability and flexibility Perfection for valve and bypass surgery consisting of 1 pair of blades	
3930	HMI-SI-4037	Sternum and Rib Retractors Exposure, stability and flexibility Perfection for valve and bypass surgery consisting of frame	
3931	HMI-SI-4038	Sternum and Rib Retractors Frame only	
3932	HMI-SI-4039	Sternum and Rib Retractors 30 x 100 mm	
3933	HMI-SI-4040	Sternum and Rib Retractors 40 x 100 mm	

3934	HMI-SI-4041	Sternum and Rib Retractors 30 x 28 mm	
3935	HMI-SI-4042	Sternum and Rib Retractors 40 x 28 mm	
3936	HMI-SI-4043	Accessories for Sternum Retractors marGate Cooley Atrium retractor, malleable St 60 x 20 mm	
3937	HMI-SI-4044	Accessories for Sternum Retractors marGate Cooley Atrium retractor, malleable St 60 x 35 mm	
3938	HMI-SI-4045	Accessories for Sternum Retractors marGate Cooley Atrium retractor, malleable St 60 x 45 mm	
3939	HMI-SI-4046	Accessories for Sternum Retractors marGate Cooley Atrium retractor, malleable Nit 60 x 20 mm	
3940	HMI-SI-4047	Accessories for Sternum Retractors marGate Cooley Atrium retractor, malleable Nit 60 x 35 mm	
3941	HMI-SI-4048	Accessories for Sternum Retractors marGate Cooley Atrium retractor, malleable Nit 60 x 45 mm	
3942	HMI-SI-4049	Accessories for Sternum Retractors marGate Cooley Fixation element	
3943	HMI-SI-4050	Accessories for Sternum Retractors marGate Valve retractor, malleable St 18 x 65 mm	
3944	HMI-SI-4051	Accessories for Sternum Retractors marGate Valve retractor, malleable St 18 x 95 mm	

3945	HMI-SI-4052	Accessories for Sternum Retractors marGate Valve retractor, malleable St 22 x 95 mm	
3946	HMI-SI-4053	Accessories for Sternum Retractors marGate Valve retractor, malleable St 25 x 75 mm	
3947	HMI-SI-4054	Accessories for Sternum Retractors marGate Valve retractor, malleable Nit 25 x 75 mm	
3948	HMI-SI-4055	Accessories for Sternum Retractors marGate Valve retractor, malleable Nit 25 x 75 mm	
3949	HMI-SI-4056	Accessories for Sternum Retractors marGate Valve retractor, malleable Nit 25 x 75 mm	
3950	HMI-SI-4057	Accessories for Sternum Retractors marGate Valve retractor, malleable Nit 25 x 75 mm	
3951	HMI-SI-4058	Rib Contractors Sellors Valves rotatable 20 cm / 7 7/8" adjustable blades	
3952	HMI-SI-4059	Rib Contractors Bailey-Baby 15,5 cm / 6 1/8"	
3953	HMI-SI-4060	Rib Contractors Bailey 20 cm / 7 7/8" short claws	
3954	HMI-SI-4061	Rib Contractors Bailey-Gibbon 20 cm / 7 7/8" long claws	







3955	HMI-SI-4062	Wound Spreaders, self-retaining 2,5 cm / 1" Epicardial spring retractor blunt	
3956	HMI-SI-4063	Wound Spreaders, self-retaining 3,5 cm / 1 3/8" Epicardial spring retractor blunt	
3957	HMI-SI-4064	Wound Spreaders, self-retaining 4 cm / 1 6/8" Epicardial spring retractor blunt	
3958	HMI-SI-4066	Wound Spreaders, self-retaining 5,5 cm / 2 3/8" Epicardial spring retractor blunt	
3959	HMI-SI-4067	Lung Spatulas Allison 29,5 cm / 11 5/8" 40 mm Working part, narrow	
3960	HMI-SI-4068	Lung Spatulas Allison 33 cm / 13 " Working part, wide 53 mm	
3961	HMI-SI-4069	Lung Spatulas 29,5 cm / 11 5/8"	
3962	HMI-SI-4070	Bronchus Clamps Price-Thomas 22 cm / 8 5/8"	





3963	HMI-SI-4071	Bronchus Clamps Price-Thomas 22 cm / 8 5/8"	
3964	HMI-SI-4072	Bronchus Clamps Price-Thomas 22 cm / 8 5/8"	
3965	HMI-SI-4073	Bronchus Clamps Semb 25 cm / 9 7/8"	
3966	HMI-SI-4074	Bronchus Clamps Semb 24,5 cm / 9 5/8"	
3967	HMI-SI-4075	Shunt Bulldog Clamps Ø 10 Fr. 7,5 cm / 3" 10°	
3968	HMI-SI-4076	Shunt Bulldog Clamps Ø 10 Fr. 7,5 cm / 3" 25°	
3969	HMI-SI-4077	Shunt Bulldog Clamps Ø 10 Fr. 7 cm / 2 6/8" 45°	
3970	HMI-SI-4078	Shunt Bulldog Clamps Ø 10 Fr. 6,5 cm / 2 4/8" 60°	
3971	HMI-SI-4079	Shunt Bulldog Clamps Ø 12 Fr. 7,5 cm / 3" 10°	
3972	HMI-SI-4080	Shunt Bulldog Clamps Ø 12 Fr. 7,5 cm / 3" 25°	
3973	HMI-SI-4081	Shunt Bulldog Clamps Ø 12 Fr. 7 cm / 2 6/8" 45°	
3974	HMI-SI-4082	Shunt Bulldog Clamps Ø 12 Fr. 6,5 cm / 2 4/8" 60°	
3975	HMI-SI-4083	Shunt Bulldog Clamps Ø 14 Fr. 7,5 cm / 3" 10°	
3976	HMI-SI-4084	Shunt Bulldog Clamps Ø 14 Fr. 7,5 cm / 3" 25°	
3977	HMI-SI-4085	Shunt Bulldog Clamps Ø 14 Fr. 7 cm / 2 6/8" 45°	
3978	HMI-SI-4086	Shunt Bulldog Clamps Ø 14 Fr. 6,5 cm / 2 4/8" 60°	





3979	HMI-SI-4087	Lung Grasping Forceps Lovelace 20,5 cm / 8 1/8"	
3980	HMI-SI-4088	Lung Grasping Forceps Lovelace 19 cm / 7 4/8"	
3981	HMI-SI-4089	Bulldog Clamps De Bakey St 8 cm / 3 1/8" 30 mm	
3982	HMI-SI-4090	Bulldog Clamps De Bakey St 9 cm / 3 4/8" 40 mm	
3983	HMI-SI-4091	Bulldog Clamps De Bakey St 10,5 cm / 4 1/8" 55 mm	
3984	HMI-SI-4092	Bulldog Clamps De Bakey St 12,5 cm / 4 7/8" 75 mm	
3985	HMI-SI-4093	Bulldog Clamps De Bakey Ti 8 cm / 3 1/8" 25 mm	
3986	HMI-SI-4094	Bulldog Clamps De Bakey Ti 9 cm / 3 4/8" 35 mm	





3987	HMI-SI-4095	Bulldog Clamps De Bakey Ti 11 cm / 4 3/8" 55 mm
3988	HMI-SI-4096	Bulldog Clamps De Bakey Ti 13 cm / 5 1/8" 75 mm
3989	HMI-SI-4097	Bulldog Clamps De Bakey St 8 cm / 3 1/8" 25 mm
3990	HMI-SI-4098	Bulldog Clamps De Bakey St 8,5 cm / 3 3/8" 35 mm
3991	HMI-SI-4099	Bulldog Clamps De Bakey St 9,5 cm / 3 6/8" 50 mm
3992	HMI-SI-4100	Bulldog Clamps De Bakey St 11,5 cm / 4 4/8" 65 mm
3993	HMI-SI-4101	Bulldog Clamps De Bakey Ti 8 cm / 3 1/8" 25 mm
3994	HMI-SI-4102	Bulldog Clamps De Bakey Ti 9 cm / 3 4/8" 30 mm













3995	HMI-SI-4103	Bulldog Clamps De Bakey Ti 10 cm / 3 7/8" 45 mm	
3996	HMI-SI-4104	Bulldog Clamps De Bakey Ti 11,5 cm / 4 4/8" 65 mm	
3997	HMI-SI-4105	Bulldog Clamps De Bakey-Satinsky 7 cm / 2 6/8" 27 mm	
3998	HMI-SI-4106	Bulldog Clamps De Bakey-Satinsky 9 cm / 3 4/8" 51 mm	
3999	HMI-SI-4107	Bulldog Clamps De Bakey-Satinsky 10 cm / 3 7/8" 60 mm	
4000	HMI-SI-4108	Bulldog Clamps Glover 6,5 cm / 2 4/8" 16 mm	
4001	HMI-SI-4109	Bulldog Clamps Santulli 7 cm / 2 6/8" 26 mm	
4002	HMI-SI-4110	Bulldog Clamps Atrauma Gregory, soft Carotid clamp 9 cm / 3 4/8" 40 mm	









4003	HMI-SI-4111	Bulldog Clamps Atrauma Gregory, soft Carotid clamp 11 cm / 4 3/8" 60 mm	
4004	HMI-SI-4112	Bulldog Clamps Atrauma Gregory Carotid clamp 11 cm / 4 3/8" 60 mm	
4005	HMI-SI-4113	Bulldog Clamps Atrauma Gregory Carotid clamp 11 cm / 4 3/8" 60 mm	
4006	HMI-SI-4114	Aortic Clamps Atrauma De Bakey-Rankin 16 cm / 6 2/8"	
4007	HMI-SI-4115	Aortic Clamps Atrauma De Bakey-Rankin 16 cm / 6 2/8"	
4008	HMI-SI-4116	Aortic Clamps Atrauma De Bakey-Mosquito 15 cm / 5 7/8"	
4009	HMI-SI-4117	Aortic Clamps Atrauma De Bakey-Mosquito 15 cm / 5 7/8"	
4010	HMI-SI-4118	Aortic Clamps Atrauma Ochsner 22 cm / 8 5/8"	



4011	HMI-SI-4119	Aortic Clamps Atrauma Diethrich 21 cm / 8 2/8"	
4012	HMI-SI-4120(a)	Multi purpose Vascular Clamps Dardik 16 cm / 6 2/8"	
4013	HMI-SI-4120(b)	Multi purpose Vascular Clamps Dardik 15,5 cm / 6 1/8" 15°	
4014	HMI-SI-4120(c)	Multi purpose Vascular Clamps Dardik 15,5 cm / 6 1/8" 30°	
4015	HMI-SI-4120(d)	Multi purpose Vascular Clamps Dardik 15,5 cm / 6 1/8" 45°	
4016	HMI-SI-4120(e)	Multi purpose Vascular Clamps Dardik 13,5 cm / 5 3/8" 90°	
4017	HMI-SI-4120(f)	Multi purpose Vascular Clamps Dardik 17 cm / 6 6/8"	
4018	HMI-SI-4121	Multi purpose Vascular Clamps Dardik 16,5 cm / 6 4/8" 15°	
4019	HMI-SI-4122	Multi purpose Vascular Clamps Dardik 16 cm / 6 2/8" 30°	
4020	HMI-SI-4123	Multi purpose Vascular Clamps Dardik 16 cm / 6 2/8" 45°	
4021	HMI-SI-4124	Multi purpose Vascular Clamps Dardik 14 cm / 5 4/8" 90°	
4022	HMI-SI-4125	Peripheral Vascular Clamps Atrauma Dale 18 cm / 7 1/8"	
4023	HMI-SI-4126	Peripheral Vascular Clamps Atrauma Dale 17,5 cm / 6 7/8"	





4024	HMI-SI-4127	Peripheral Vascular Clamps Atrauma Dale 18 cm / 7 1/8"	
4025	HMI-SI-4128	Peripheral Vascular Clamps Atrauma Dale 18,5 cm / 7 2/8"	
4026	HMI-SI-4129	Profunda Clamps Gregory 13,5 cm / 5 3/8"	
4027	HMI-SI-4130	Profunda Clamps Gregory 16 cm / 6 2/8"	
4028	HMI-SI-4131	Profunda Clamps Gregory 18 cm / 7 1/8"	
4029	HMI-SI-4132	Carotid Shunt Clamps Javid 17,5 cm / 6 7/8"	
4030	HMI-SI-4133	Carotid Shunt Clamps Javid 18,5 cm / 7 2/8"	
4031	HMI-SI-4134	Peripheral Vascular Clamps Atrauma Martin 16 cm / 6 2/8"	





4032	HMI-SI-4135	Peripheral Vascular Clamps Atrauma Martin 18 cm / 7 1/8"	
4033	HMI-SI-4136	Peripheral Vascular Clamps Atrauma Martin 17 cm / 6 6/8"	
4034	HMI-SI-4137	Peripheral Vascular Clamps Atrauma Martin 19,5 cm / 7 5/8"	
4035	HMI-SI-4138	Aortic Clamps Atrauma Wylie 24 cm / 9 4/8"	
4036	HMI-SI-4139	Aortic Clamps Atrauma Wylie 27 cm / 10 5/8"	
4037	HMI-SI-4140	Aortic Clamps Atrauma De Bakey 30 cm / 11 6/8"	
4038	HMI-SI-4141	Peripheral Vascular Clamps Atrauma Husfeldt 16,5 cm / 6 4/8"	
4039	HMI-SI-4142	Peripheral Vascular Clamps Atrauma Husfeldt 18 cm / 7 1/8"	





4040	HMI-SI-4143	Peripheral Vascular Clamps Atrauma Husfeldt 17 cm / 6 6/8"	
4041	HMI-SI-4144	Vascular Measuring Device, Peripheral Vascular Clamps Martin 18 cm / 7 1/8" Vascular Measuring Device	
4042	HMI-SI-4145	Vascular Measuring Device, Peripheral Vascular Clamps Atrauma Henly 20 cm / 7 7/8"	
4043	HMI-SI-4146	Catheter Clamps Atrauma Cooley 17 cm / 6 6/8" 20 Charr.	
4044	HMI-SI-4147	Catheter Clamps Atrauma Cooley 17 cm / 6 6/8" 24 Charr.	
4045	HMI-SI-4148	Catheter Clamps Atrauma Cooley 20 cm / 7 7/8" 28 Charr.	
4046	HMI-SI-4149	Catheter Clamps Atrauma Cooley 20 cm / 7 7/8" 30 Charr.	
4047	HMI-SI-4150	Catheter Clamps Atrauma Cooley 20 cm / 7 7/8" 32 Charr.	
4048	HMI-SI-4151	Catheter Clamps Atrauma Cooley 20 cm / 7 7/8" 36 Charr.	
4049	HMI-SI-4152	Catheter Clamps Atrauma Cooley 20 cm / 7 7/8" 38 Charr.	
4050	HMI-SI-4153	Catheter Clamps Atrauma Cooley 20 cm / 7 7/8" 40 Charr.	
4051	HMI-SI-4154	Abdominal Aortic Clamps Atrauma Zanger 21,5 cm / 8 4/8"	



4052	HMI-SI-4155	Abdominal Aortic Clamps Atrauma Zanger 25 cm / 9 7/8"	
4053	HMI-SI-4156	Abdominal Aortic Clamps Atrauma Zanger 30,5 cm / 12"	
4054	HMI-SI-4157	Abdominal Aortic Clamps Atrauma Grant 24,5 cm / 9 6/8"	
4055	HMI-SI-4158	Abdominal Aortic Clamps Atrauma cooley 19 cm / 7 4/8"	
4056	HMI-SI-4159	Abdominal Aortic Clamps Atrauma cooley 26,5 cm / 10 4/8"	
4057	HMI-SI-4160	Abdominal Aortic Clamps Atrauma cooley 33,5 cm / 13 4/8"	
4058	HMI-SI-4161	Abdominal Aortic Clamps Atrauma cooley 26 cm / 10 2/8"	
4059	HMI-SI-4162	Abdominal Aortic Clamps Atrauma cooley 31,5 cm / 12 2/8"	



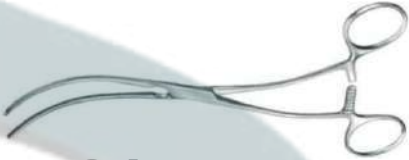

4060	HMI-SI-4163(a)	Vascular Forceps Atrauma De Bakey 16 cm / 6 2/8" 1,5 mm		
4061	HMI-SI-4163(b)	Vascular Forceps Atrauma De Bakey 20 cm / 7 7/8" 1,5 mm		
4062	HMI-SI-4163(c)	Vascular Forceps Atrauma De Bakey 25 cm / 9 7/8" 1,5 mm		
4063	HMI-SI-4163(d)	Vascular Forceps Atrauma De Bakey 16 cm / 6 2/8" 2,0 mm		
4064	HMI-SI-4164	Vascular Forceps Atrauma De Bakey 20 cm / 7 7/8" 2,0 mm		
4065	HMI-SI-4165	Vascular Forceps Atrauma De Bakey 25 cm / 9 7/8" 2,0 mm		
4066	HMI-SI-4166	Vascular Forceps Atrauma De Bakey 30 cm / 11 6/8" 2,0 mm		
4067	HMI-SI-4167	Vascular Forceps Atrauma De Bakey 16 cm / 6 2/8" 2,7 mm		
4068	HMI-SI-4168	Vascular Forceps Atrauma De Bakey 20 cm / 7 7/8" 2,7 mm		
4069	HMI-SI-4169	Vascular Forceps Atrauma De Bakey 25 cm / 9 7/8" 2,7 mm		
4070	HMI-SI-4170	Vascular Forceps Atrauma De Bakey 30 cm / 11 6/8" 2,7 mm		
4071	HMI-SI-4171	Vascular Forceps Atrauma De Bakey 16 cm / 6 2/8" 3,5 mm		
4072	HMI-SI-4172	Vascular Forceps Atrauma De Bakey 20 cm / 7 7/8" 3,5 mm		
4073	HMI-SI-4173	Vascular Forceps Atrauma De Bakey 25 cm / 9 7/8" 3,5 mm		
4074	HMI-SI-4174	Vascular Forceps Atrauma De Bakey 30 cm / 11 6/8" 3,5 mm		
4075	HMI-SI-4175	Vascular Forceps, Bulldog Clamps Atrauma De Bakey 16 cm / 6 2/8" 2,0 mm		
4076	HMI-SI-4176	Vascular Forceps, Bulldog Clamps Atrauma De Bakey 20 cm / 7 7/8" 2,0 mm		









4077	HMI-SI-4177	Vascular Forceps, Bulldog Clamps Atrauma De Bakey 25 cm / 9 7/8" 2,0 mm	
4078	HMI-SI-4178	Vascular Forceps, Bulldog Clamps Atrauma De Bakey 30 cm / 11 6/8" 2,0 mm	
4079	HMI-SI-4179	Vascular Forceps, Bulldog Clamps Atrauma 9,5 cm / 3 6/8" Gregory-Style right 74 mm	
4080	HMI-SI-4180	Vascular Forceps, Bulldog Clamps Atrauma 9,5 cm / 3 6/8" Gregory-Style left 74 mm	
4081	HMI-SI-4181	Bulldog Clamps Atrauma Glover St 7 cm / 2 6/8" 30 mm	
4082	HMI-SI-4182	Bulldog Clamps Atrauma Glover St 8 cm / 3 1/8" 40 mm	
4083	HMI-SI-4183	Bulldog Clamps Atrauma Glover St 9,5 cm / 3 6/8" 50 mm	
4084	HMI-SI-4184	Bulldog Clamps Atrauma Glover St 11 cm / 4 2/8" 70 mm	
4085	HMI-SI-4185	Bulldog Clamps Atrauma Glover St 16,5 cm / 2 4/8" 25 mm	
4086	HMI-SI-4186	Bulldog Clamps Atrauma Glover St 7,5 cm / 3" 35 mm	
4087	HMI-SI-4187	Bulldog Clamps Atrauma Glover St 9,0 cm / 3 4/8" 45 mm	
4088	HMI-SI-4188	Bulldog Clamps Atrauma Glover St 10,5 cm / 4" 65 mm	
4089	HMI-SI-4188(a)	Bulldog Clamps Atrauma Applying Forceps for Bulldog clamps 24 cm / 9 4/8"	





4090	HMI-SI-4189	Coarctation Clamps Atrauma Potts 21 cm / 8 2/8"	
4091	HMI-SI-4190	Coarctation Clamps Atrauma Potts 22,5 cm / 8 7/8"	
4092	HMI-SI-4191	Coarctation Clamps Atrauma Potts 20,5 cm / 8 1/8"	
4093	HMI-SI-4192	Coarctation Clamps Atrauma Potts 22 cm / 8 5/8"	
4094	HMI-SI-4193	Coarctation Clamps Atrauma Potts 20,5 cm / 8"	
4095	HMI-SI-4194	Coarctation Clamps Atrauma Potts 22 cm / 8 6/8"	
4096	HMI-SI-4195	Anastomosenklemmen, Ligaturklemmen Atrauma Potts 21,5 cm / 8 4/8"	
4097	HMI-SI-4196	Anastomosenklemmen, Ligaturklemmen Atrauma Potts 22 cm / 8 5/8"	



4098	HMI-SI-4197	Anastomosenklemmen, Ligaturklemmen Atrauma De Bakey 19 cm / 7 4/8"	
4099	HMI-SI-4198	Anastomosenklemmen, Ligaturklemmen Atrauma De Bakey 24 cm / 9 4/8"	
4100	HMI-SI-4199	Peripheral Vascular Clamps Atrauma De Bakey 16 cm / 6 2/8"	
4101	HMI-SI-4200	Peripheral Vascular Clamps Atrauma De Bakey 19 cm / 7 4/8"	
4102	HMI-SI-4201	Peripheral Vascular Clamps Atrauma De Bakey 20 cm / 7 7/8"	
4103	HMI-SI-4202	Peripheral Vascular Clamps Atrauma Leland-Jones 18 cm / 7 1/8"	
4104	HMI-SI-4203	Peripheral Vascular Clamps Atrauma Leland-Jones 19 cm / 7 4/8"	
4105	HMI-SI-4204	Peripheral Vascular Clamps Atrauma Leland-Jones 20 cm / 7 7/8"	







4106	HMI-SI-4205	Multi purpose Vascular Clamps Atrauma Bainbridge 15 cm / 5 7/8"	
4107	HMI-SI-4206	Multi purpose Vascular Clamps Atrauma Bainbridge 18,5 cm / 7 2/8"	
4108	HMI-SI-4207	Multi purpose Vascular Clamps Atrauma Bainbridge 15 cm / 5 7/8"	
4109	HMI-SI-4208	Multi purpose Vascular Clamps Atrauma Bainbridge 18,5 cm / 7 2/8"	
4110	HMI-SI-4209	Multi purpose Vascular Clamps Atrauma De Bakey 20 cm / 7 7/8"	
4111	HMI-SI-4210	Aortic Clamps Atrauma Kowalski 26 cm / 10 2/8" 50 mm	
4112	HMI-SI-4211	Aortic Clamps Atrauma Kowalski 27 cm / 10 2/8" 65 mm	
4113	HMI-SI-4212	Aortic Clamps Atrauma Kowalski 28 cm / 11" 90 mm	



4114	HMI-SI-4213	Aortic Aneurysm Clamps Atrauma De Bakey 26 cm / 10 2/8"	
4115	HMI-SI-4214	Aortic Aneurysm Clamps Atrauma De Bakey 27 cm / 10 5/8"	
4116	HMI-SI-4215	Aortic Aneurysm Clamps Atrauma De Bakey 31 cm / 12 2/8"	
4117	HMI-SI-4216	Aortic Aneurysm Clamps Atrauma De Bakey 33 cm / 13"	
4118	HMI-SI-4217	Aneurysm Clamps Atrauma De Bakey 28 cm / 11"	
4119	HMI-SI-4218	Aneurysm Clamps Atrauma De Bakey 30 cm / 11 6/8"	
4120	HMI-SI-4219	Aneurysm Clamps Atrauma Cooley 25 cm / 9 7/8"	
4121	HMI-SI-4220	Aneurysm Clamps Atrauma De Bakey 27 cm / 10 5/8"	



4122	HMI-SI-4221	Ligature Forceps, Aortic Clamps Atrauma De Bakey 24,5 cm / 9 5/8"	
4123	HMI-SI-4222	Ligature Forceps, Aortic Clamps Atrauma De Bakey 24,5 cm / 9 5/8"	
4124	HMI-SI-4223	Ligature Forceps, Aortic Clamps Atrauma De Bakey 27 cm / 10 5/8"	
4125	HMI-SI-4224	Ligature Forceps, Aortic Clamps Atrauma De Bakey 27 cm / 10 5/8"	
4126	HMI-SI-4225	Aortic Clamps Atrauma Weber 24 cm / 9 4/8"	
4127	HMI-SI-4226	Aortic Clamps Atrauma Weber 24 cm / 9 4/8"	
4128	HMI-SI-4227(a)	Aortic Clamps, Anastomosis Clamps, Vena Cava Clamps Atrauma Wylie 22,5 cm / 8 7/8"	
4129	HMI-SI-4227(b)	Aortic Clamps, Anastomosis Clamps, Vena Cava Clamps Atrauma Wylie 23 cm / 9"	



4130	HMI-SI-4228	Aortic Clamps, Anastomosis Clamps, Vena Cava Clamps Atrauma Calne 27 cm / 10 5/8"	
4131	HMI-SI-4229	Liver Forceps Atrauma Pittsburgh 25 cm / 9 7/8"	
4132	HMI-SI-4230	Liver Forceps Atrauma Pittsburgh 26 cm / 10 2/8"	
4133	HMI-SI-4231	Liver Forceps Atrauma Pittsburgh 27 cm / 10 5/8"	
4134	HMI-SI-4232	Forceps for kidney and pancreas Atrauma 20 cm / 7 7/8"	
4135	HMI-SI-4233	Forceps for kidney and pancreas Atrauma 20 cm / 7 7/8"	
4136	HMI-SI-4234	Forceps for kidney and pancreas Atrauma 20 cm / 7 7/8"	
4137	HMI-SI-4235	Forceps for kidney and pancreas Atrauma Satinsky 15,5 cm / 6"	

4138	HMI-SI-4236	Tangential Occlusion Clamps Atrauma Satinsky 22 cm / 8 6/8"	
4139	HMI-SI-4237	Tangential Occlusion Clamps Atrauma Satinsky 26 cm / 10 2/8"	
4140	HMI-SI-4238	Tangential Occlusion Clamps Atrauma Satinsky 26,5 cm / 10 4/8"	
4141	HMI-SI-4239	Tangential Occlusion Clamps Atrauma Satinsky 27,5 cm / 10 6/8"	
4142	HMI-SI-4240	Tangential Occlusion Clamps Atrauma Satinsky 28,5 cm / 11 2/8"	
4143	HMI-SI-4241	Auricle Clamps Atrauma Harken 24,5 cm / 9 6/8"	
4144	HMI-SI-4242	Auricle Clamps Atrauma Harken 24 cm / 9 4/8"	
4145	HMI-SI-4243	Auricle Clamps Atrauma Harken 23 cm / 9"	
4146	HMI-SI-4244	Auricle Clamps Atrauma Harken 23,5 cm / 9 2/8"	
4147	HMI-SI-4245	Bronchus Clamps Atrauma Lees 23 cm / 9 "	





4148	HMI-SI-4246	Bronchus Clamps Atrauma Lees 25,5 cm / 10 "	
4149	HMI-SI-4247	Bronchus Clamps Atrauma Lees 26 cm / 10 2/8"	
4150	HMI-SI-4248	Anastomosis Clamps Atrauma Glover 18 cm / 7 1/8"	
4151	HMI-SI-4249	Anastomosis Clamps Atrauma Glover 22 cm / 8 5/8"	
4152	HMI-SI-4250	Aortic Clamps, Anastomosis Clamps Atrauma Lambert-Kay 22,5 cm / 8 6/8"	
4153	HMI-SI-4251	Aortic Clamps, Anastomosis Clamps Atrauma Lambert-Kay 20,5 cm / 8 1/8"	
4154	HMI-SI-4252	Aortic Clamps, Anastomosis Clamps Atrauma De Bakey 16,5 cm / 6 4/8"	
4155	HMI-SI-4253	Aortic Clamps, Anastomosis Clamps Atrauma Morris-De Bakey 18,5 cm / 7 2/8"	



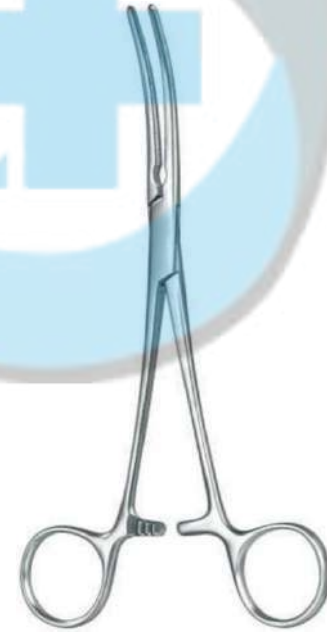

4156	HMI-SI-4254	Aortic Clamps, Anastomosis Clamps Atrauma Morris-De Bakey 20 cm / 8"	
4157	HMI-SI-4255	Aortic Clamps, Anastomosis Clamps Atrauma Morris-De Bakey 26 cm / 10 2/8"	
4158	HMI-SI-4256	Aortic Clamps, Anastomosis Clamps Atrauma Morris-De Bakey 27,5 cm / 10 7/8"	
4159	HMI-SI-4257	Aneurysm Clamps Atrauma De Bakey-Bahnson 23,5 cm / 9 2/8"	
4160	HMI-SI-4258	Aneurysm Clamps Atrauma De Bakey-Bahnson 24,5 cm / 9 5/8"	
4161	HMI-SI-4259	Aneurysm Clamps Atrauma De Bakey-Bahnson 25,5 cm / 10 "	
4162	HMI-SI-4260	Aneurysm Clamps Atrauma De Bakey-Bahnson 26,5 cm / 10 4/8"	
4163	HMI-SI-4261	Multi purpose Vascular Clamps Atrauma Potts 21,5 cm / 8 4/8"	

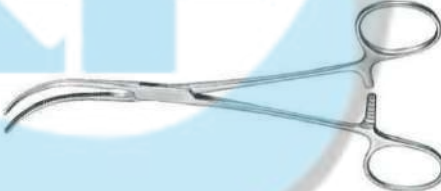

4164	HMI-SI-4262	Multi purpose Vascular Clamps Atrauma Potts 23,5 cm / 9 2/8"	
4165	HMI-SI-4263	Multi purpose Vascular Clamps Atrauma Potts 27 cm / 10 5/8"	
4166	HMI-SI-4264	Multi purpose Vascular Clamps Atrauma Potts 31,5 cm / 12 3/8"	
4167	HMI-SI-4265	Multi purpose Vascular Clamps Atrauma Potts 21 cm / 8 2/8"	
4168	HMI-SI-4266	Multi purpose Vascular Clamps Atrauma Potts 23 cm / 9 "	
4169	HMI-SI-4267	Multi purpose Vascular Clamps Atrauma Potts 26 cm / 10 2/8"	
4170	HMI-SI-4268	Multi purpose Vascular Clamps Atrauma Potts 31 cm / 12 2/8"	
4171	HMI-SI-4269	Multi purpose Vascular Clamps Atrauma De Bakey 27,5 cm / 10 6/8"	

4172	HMI-SI-4270	Multi purpose Vascular Clamps Atrauma De Bakey 23 cm / 9"	
4173	HMI-SI-4271	Multi purpose Vascular Clamps Atrauma De Bakey 20 cm / 7 7/8"	
4174	HMI-SI-4272	Multi purpose Vascular Clamps Atrauma De Bakey 19 cm / 7 4/8"	
4175	HMI-SI-4273	Multi purpose Vascular Clamps Atrauma De Bakey 18 cm / 7 1/8"	
4176	HMI-SI-4274	Multi purpose Vascular Clamps Atrauma De Bakey 21 cm / 8 2/8"	
4177	HMI-SI-4275	Multi purpose Vascular Clamps Atrauma De Bakey 22 cm / 8 6/8"	
4178	HMI-SI-4276	Multi purpose Vascular Clamps Atrauma De Bakey 26 cm / 10 2/8"	
4179	HMI-SI-4277	Multi purpose Vascular Clamps Atrauma De Bakey 31,5 cm / 12 3/8"	
4180	HMI-SI-4278	Haemostatic Forceps Atrauma De Bakey-Mosquito 12,5 cm / 4 7/8"	
4181	HMI-SI-4279	Haemostatic Forceps Atrauma De Bakey-Mosquito 12,5 cm / 4 7/8"	

4182	HMI-SI-4280	Haemostatic Forceps Atrauma De Bakey-Pean 14,5 cm / 5 6/8"		
4183	HMI-SI-4281	Haemostatic Forceps Atrauma De Bakey-Pean 16,5 cm / 6 4/8"		
4184	HMI-SI-4282	Haemostatic Forceps Atrauma De Bakey-Pean 18,5 cm / 7 2/8"		
4185	HMI-SI-4283	Haemostatic Forceps Atrauma De Bakey-Pean 20,5 cm / 8 1/8"		
4186	HMI-SI-4284	Haemostatic Forceps Atrauma De Bakey-Pean 14,5 cm / 5 6/8"		
4187	HMI-SI-4285	Haemostatic Forceps Atrauma De Bakey-Pean 16,5 cm / 6 4/8"		
4188	HMI-SI-4286	Haemostatic Forceps Atrauma De Bakey-Pean 18,5 cm / 7 2/8"		
4189	HMI-SI-4287	Haemostatic Forceps Atrauma De Bakey-Pean 20,5 cm / 8 1/8"		





4190	HMI-SI-4288	Multi purpose Vascular Clamps Atrauma De Bakey 17,5 cm / 6 7/8"	
4191	HMI-SI-4289	Multi purpose Vascular Clamps Atrauma De Bakey 16,5 cm / 6 4/8"	
4192	HMI-SI-4290	Multi purpose Vascular Clamps Atrauma De Bakey 16 cm / 6 2/8"	
4193	HMI-SI-4291	Multi purpose Vascular Clamps Atrauma De Bakey 15 cm / 5 7/8"	
4194	HMI-SI-4292	Multi purpose Vascular Clamps Atrauma De Bakey 16,5 cm / 6 4/8"	
4195	HMI-SI-4293	Multi purpose Vascular Clamps Atrauma Glover 17 cm / 6 6/8"	
4196	HMI-SI-4294	Multi purpose Vascular Clamps Atrauma Glover 17,5 cm / 6 7/8"	
4197	HMI-SI-4295	Multi purpose Vascular Clamps Atrauma Glover 21 cm / 8 2/8"	





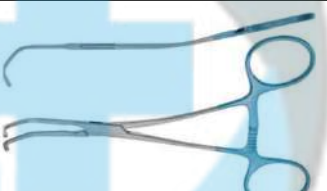

4198	HMI-SI-4296	Multi purpose Vascular Clamps Atrauma Glover 26 cm / 10 2/8"	
4199	HMI-SI-4297	Anastomosis Clamps Atrauma De Bakey 16,5 cm / 6 4/8"	
4200	HMI-SI-4298	Anastomosis Clamps Atrauma De Bakey 16,5 cm / 6 4/8"	
4201	HMI-SI-4299	Anastomosis Clamps Atrauma De Bakey-Reynolds 16,5 cm / 6 4/8"	
4202	HMI-SI-4300	Anastomosis Clamps Atrauma De Bakey-Reynolds 17,5 cm / 6 5/8"	
4203	HMI-SI-4301	Anastomosis Clamps Atrauma Derra 16,5 cm / 6 4/8"	
4204	HMI-SI-4302	Anastomosis Clamps Atrauma Derra 17 cm / 6 6/8"	
4205	HMI-SI-4303	Anastomosis Clamps Atrauma Derra 17,5 cm / 6 5/8"	





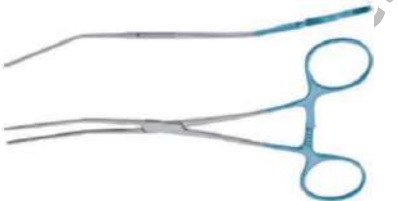
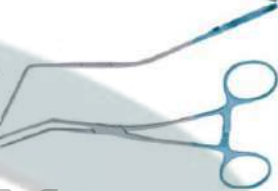

4206	HMI-SI-4304	Anastomosis Clamps Atrauma De Bakey-Beck 17 cm / 6 6/8"	
4207	HMI-SI-4305	Anastomosis Clamps Atrauma De Bakey-Beck 19 cm / 7 4/8"	
4208	HMI-SI-4306	Anastomosis Clamps Atrauma De Bakey-Beck 21 cm / 8 2/8"	
4209	HMI-SI-4307	Pediatric Vascular Clamps Atrauma De Bakey 10 cm / 3 7/8"	
4210	HMI-SI-4308	Pediatric Vascular Clamps Atrauma De Bakey 13 cm / 5 1/8"	
4211	HMI-SI-4309	Pediatric Vascular Clamps Atrauma De Bakey 13 cm / 5 1/8"	
4212	HMI-SI-4310	Pediatric Vascular Clamps Atrauma De Bakey 12,5 cm / 4 7/8"	
4213	HMI-SI-4311	Pediatric Vascular Clamps Atrauma De Bakey 12,5 cm / 4 7/8"	
4214	HMI-SI-4312	Pediatric Vascular Clamps Ti Castañeda 13 cm / 5 1/8"	



4215	HMI-SI-4313	Pediatric Vascular Clamps Ti Castañeda 12,5 cm / 4 7/8"
4216	HMI-SI-4314	Pediatric Vascular Clamps Ti Castañeda 12 cm / 4 6/8"
4217	HMI-SI-4315	Pediatric Vascular Clamps Ti Castañeda 12 cm / 4 6/8"
4218	HMI-SI-4316	Pediatric Vascular Clamps Ti Castañeda 11 cm / 4 3/8"
4219	HMI-SI-4317	Pediatric Vascular Clamps Ti Castañeda 12 cm / 4 6/8"
4220	HMI-SI-4318	Pediatric Vascular Clamps Ti Castañeda 15 cm / 5 7/8"
4221	HMI-SI-4319	Pediatric Vascular Clamps Ti Castañeda 15 cm / 5 7/8"
4222	HMI-SI-4320	Pediatric Vascular Clamps Ti Castañeda 15 cm / 5 7/8"
4223	HMI-SI-4321	Pediatric Vascular Clamps Ti Castañeda 15 cm / 5 7/8"
4224	HMI-SI-4322	Pediatric Vascular Clamps Ti Castañeda 15 cm / 5 7/8"
4225	HMI-SI-4323	Pediatric Vascular Clamps Atrauma Ti De Bakey baby 13,5 cm / 5 3/8"
4226	HMI-SI-4324	Pediatric Vascular Clamps Atrauma Ti De Bakey baby 13,5 cm / 5 3/8"
4227	HMI-SI-4325	Pediatric Vascular Clamps Atrauma Ti De Bakey baby 13 cm / 5 1/8"
4228	HMI-SI-4326	Pediatric Vascular Clamps Atrauma Ti De Bakey baby 12,5 cm / 4 7/8"
4229	HMI-SI-4327	Pediatric Vascular Clamps Atrauma Ti De Bakey baby 13,5 cm / 5 3/8"
4230	HMI-SI-4328	Pediatric Vascular Clamps Atrauma Ti De Bakey baby 12 cm / 4 6/8"
4231	HMI-SI-4329	Pediatric Vascular Clamps Atrauma Ti De Bakey baby 12 cm / 4 6/8"
4232	HMI-SI-4330	Pediatric Vascular Clamps Atrauma Ti De Bakey baby 12,5 cm / 4 7/8"
4233	HMI-SI-4331	Pediatric Vascular Clamps Atrauma Ti De Bakey baby 13 cm / 5 1/8"
4234	HMI-SI-4332	Pediatric Vascular Clamps Atrauma Ti De Bakey baby 14 cm / 5 4/8"

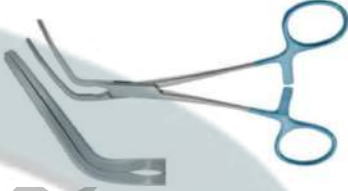
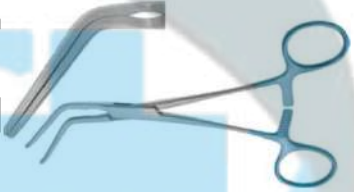





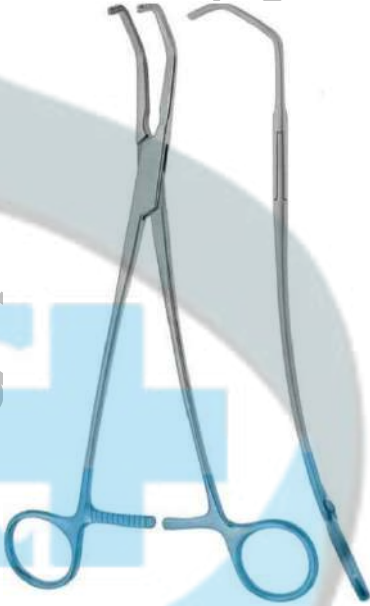





4235	HMI-SI-4333	Pediatric Vascular Clamps Atrauma Ti De Bakey baby 14 cm / 5 4/8"	
4236	HMI-SI-4335	Pediatric Vascular Clamps Atrauma Ti Cooley 14 cm / 5 4/8"	
4237	HMI-SI-4336	Pediatric Vascular Clamps Atrauma Ti Cooley 14 cm / 5 4/8"	
4238	HMI-SI-4337	Pediatric Vascular Clamps Atrauma Ti Cooley 14 cm / 5 4/8"	
4239	HMI-SI-4338	Pediatric Vascular Clamps Atrauma Ti Cooley 13,5 cm / 5 3/8"	
4240	HMI-SI-4339	Pediatric Vascular Clamps Atrauma Ti Cooley 13,5 cm / 5 3/8"	
4241	HMI-SI-4340	Pediatric Vascular Clamps Atrauma Ti Cooley 11,5 cm / 4 4/8"	
4242	HMI-SI-4341	Pediatric Vascular Clamps Atrauma Ti Cooley 11,5 cm / 4 4/8"	





4243	HMI-SI-4342	Pediatric Vascular Clamps Atrauma Ti Cooley 11,5 cm / 4 4/8"	
4244	HMI-SI-4343	Pediatric Vascular Clamps Atrauma Ti De Bakey baby 16,5 cm / 6 4/8"	
4245	HMI-SI-4344	Pediatric Vascular Clamps Atrauma Ti De Bakey baby 16 cm / 6 2/8"	
4246	HMI-SI-4345	Pediatric Vascular Clamps Atrauma Ti De Bakey baby 15 cm / 5 7/8"	
4247	HMI-SI-4346	Pediatric Vascular Clamps Atrauma Ti De Bakey baby 15 cm / 5 7/8"	
4248	HMI-SI-4347	Pediatric Vascular Clamps Atrauma Ti De Bakey baby 15 cm / 5 7/8"	
4249	HMI-SI-4348	Pediatric Vascular Clamps Atrauma Ti De Bakey 13 cm / 5 1/8"	
4250	HMI-SI-4349	Pediatric Vascular Clamps Atrauma Ti De Bakey 12,5 cm / 4 7/8"	





4251	HMI-SI-4350	Pediatric Vascular Clamps Atrauma Ti De Bakey 10 cm / 3 7/8"	
4252	HMI-SI-4351	Pediatric Vascular Clamps Atrauma Ti De Bakey 12,5 cm / 4 7/8"	
4253	HMI-SI-4352	Pediatric Vascular Clamps Atrauma Ti De Bakey 12,5 cm / 4 7/8"	
4254	HMI-SI-4353	Aortic Clamps Atrauma Ti Subramanian 15,5 cm / 6 1/8"	
4255	HMI-SI-4354	Aortic Clamps Atrauma Ti Subramanian 15,5 cm / 6 1/8"	
4256	HMI-SI-4355	Aortic Clamps Atrauma Ti Subramanian 16,5 cm / 6 2/8"	
4257	HMI-SI-4356	Aortic Clamps Atrauma Ti Subramanian 16 cm / 6 2/8"	
4258	HMI-SI-4357	Anastomosis Clamps Atrauma Ti De Bakey-Derra 16,5 cm / 6 4/8"	

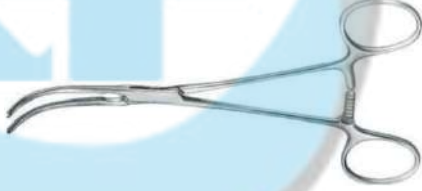



4259	HMI-SI-4358	Anastomosis Clamps Atrauma Ti De Bakey-Derra 16,5 cm / 6 4/8"	
4260	HMI-SI-4359	Anastomosis Clamps Atrauma Ti De Bakey-Derra 16,5 cm / 6 4/8"	
4261	HMI-SI-4360	Tangential Occlusion Clamps Atrauma Ti De Bakey-Satinsky 23,5 cm / 9 2/8"	
4262	HMI-SI-4361	Tangential Occlusion Clamps Atrauma Ti De Bakey-Satinsky 24 cm / 9 4/8"	
4263	HMI-SI-4362	Tangential Occlusion Clamps Atrauma Ti De Bakey-Satinsky 24,5 cm / 9 6/8"	
4264	HMI-SI-4363	Tangential Occlusion Clamps Atrauma Ti De Bakey-Satinsky 25 cm / 9 7/8"	
4265	HMI-SI-4364	Tangential Occlusion Clamps Atrauma Ti De Bakey-Satinsky 28,5 cm / 11 2/8"	
4266	HMI-SI-4365	Tangential Occlusion Clamps Atrauma Ti Lambert-Kay 19,5 cm / 7 5/8"	

4267	HMI-SI-4366	Aortic Clamps Atrauma Ti De Bakey 26 cm / 10 2/8"	
4268	HMI-SI-4367	Aortic Clamps Atrauma Ti De Bakey 26,5 cm / 10 4/8"	
4269	HMI-SI-4368	Aortic Clamps Atrauma Ti De Bakey 31 cm / 12 2/8"	
4270	HMI-SI-4369	Aortic Clamps Atrauma Ti De Bakey 33 cm / 13"	
4271	HMI-SI-4370	Vascular Forceps Atrauma Cooley 16 cm / 6 2/8" 2,0 mm	
4272	HMI-SI-4371	Vascular Forceps Atrauma Cooley 20 cm / 7 7/8" 2,0 mm	
4273	HMI-SI-4372	Pediatric Vascular Clamps Atrauma Cooley 11,5 cm / 4 4/8"	
4274	HMI-SI-4373	Pediatric Vascular Clamps Atrauma Cooley 14,5 cm / 5 6/8"	
4275	HMI-SI-4374	Pediatric Vascular Clamps Atrauma Cooley 14,5 cm / 5 6/8"	
4276	HMI-SI-4375	Pediatric Vascular Clamps Atrauma Cooley 14 cm / 5 4/8"	

4277	HMI-SI-4376	Pediatric Vascular Clamps Atrauma Cooley 14,5 cm / 5 6/8"	
4278	HMI-SI-4377	Pediatric Vascular Clamps Atrauma Cooley 12,5 cm / 4 7/8"	
4279	HMI-SI-4378	Pediatric Vascular Clamps Atrauma Cooley 14,5 cm / 5 6/8"	
4280	HMI-SI-4379	Anastomosis Clamps, Multi purpose Vascular Clamps Atrauma Cooley 22 cm / 8 5/8" Iliac Clamp	
4281	HMI-SI-4380	Anastomosis Clamps, Multi purpose Vascular Clamps Atrauma Cooley 17 cm / 6 6/8"	
4282	HMI-SI-4381	Anastomosis Clamps, Multi purpose Vascular Clamps Atrauma Cooley 20 cm / 7 7/8" Carotid Clamp	
4283	HMI-SI-4382	Anastomosis Clamps, Multi purpose Vascular Clamps Atrauma Cooley-Parry 18 cm / 7 1/8"	
4284	HMI-SI-4383	Anastomosis Clamps, Multi purpose Vascular Clamps Atrauma Cooley-Parry 26 cm / 10 2/8"	
4285	HMI-SI-4384	Anastomosis Clamps, Multi purpose Vascular Clamps Atrauma Cooley 17 cm / 6 6/8"	

4286	HMI-SI-4385	Anastomosis Clamps, Multi purpose Vascular Clamps Atrauma Cooley 16 cm / 6 2/8"	
4287	HMI-SI-4386	Anastomosis Clamps, Multi purpose Vascular Clamps Atrauma Cooley 14,5 cm / 5 6/8"	
4288	HMI-SI-4387	Anastomosis Clamps, Multi purpose Vascular Clamps Atrauma Cooley 16 cm / 6 2/8"	
4289	HMI-SI-4388	Anastomosis Clamps, Multi purpose Vascular Clamps Atrauma Cooley 16,5 cm / 6 4/8"	
4290	HMI-SI-4389	Anastomosis Clamps Atrauma Cooley 17 cm / 6 6/8"	
4291	HMI-SI-4390	Anastomosis Clamps Atrauma Cooley 17 cm / 6 6/8"	
4292	HMI-SI-4391	Anastomosis Clamps Atrauma Cooley 26,5 cm / 10 4/8"	
4293	HMI-SI-4392	Anastomosis Clamps Atrauma Cooley 26,5 cm / 10 4/8"	

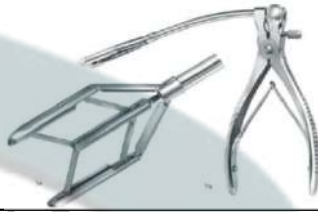
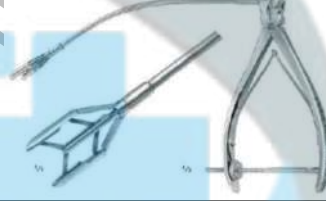
4294	HMI-SI-4393	Anastomosis Clamps Atrauma Cooley 27,5 cm / 10 6/8"	
4295	HMI-SI-4394	Anastomosis Clamps Atrauma Cooley 17,5 cm / 6 7/8"	
4296	HMI-SI-4395	Anastomosis Clamps Atrauma Cooley 16,5 cm / 6 4/8"	
4297	HMI-SI-4396	Anastomosis Clamps Atrauma Cooley 16,5 cm / 6 4/8"	
4298	HMI-SI-4397	Anastomosis Clamps Atrauma Cooley-Derra 16,5 cm / 6 4/8"	
4299	HMI-SI-4398	Anastomosis Clamps Atrauma Cooley-Derra 17 cm / 6 6/8"	
4300	HMI-SI-4399	Anastomosis Clamps Atrauma Cooley-Derra 17,5 cm / 6 7/8"	
4301	HMI-SI-4400	Anastomosis Clamps Atrauma Cooley-Derra 21 cm / 8 2/8"	





4302	HMI-SI-4401	Anastomosis Clamps Atrauma Cooley-Beck 17 cm / 6 6/8"	
4303	HMI-SI-4402	Anastomosis Clamps Atrauma Allenberg Cobra 23,5 cm / 9 2/8"	
4304	HMI-SI-4403	Anastomosis Clamps Atrauma Allenberg Cobra 26,5 cm / 10 3/8"	
4305	HMI-SI-4404	Aortic Dilators Tubbs spreading 8 - 42 mm, with fixation screw for mitral stenosis	
4306	HMI-SI-4405	Aortic Dilators Cooley Spreizweite 5 - 20 mm, mit Gewindesperre spreading 5 - 20 mm, with thread fixation for mitral stenosis	
4307	HMI-SI-4406	Vascular Dilators Cooley St 14 cm / 5 4/8" Ø 0.5 mm	
4308	HMI-SI-4407	Vascular Dilators Cooley St 14 cm / 5 4/8" Ø 1.0 mm	
4309	HMI-SI-4408	Vascular Dilators Cooley St 14 cm / 5 4/8" Ø 1.5 mm	
4310	HMI-SI-4409	Vascular Dilators Cooley Ti 14 cm / 5 4/8" Ø 0.5 mm	
4311	HMI-SI-4410	Vascular Dilators Cooley Ti 14 cm / 5 4/8" Ø 1.0 mm	
4312	HMI-SI-4411	Vascular Dilators Cooley Ti 14 cm / 5 4/8" Ø 1.5 mm	
4313	HMI-SI-4412	Vascular Dilators Cooley St 19 cm / 7 4/8" Ø 0.5 mm	
4314	HMI-SI-4413	Vascular Dilators Cooley St 19 cm / 7 4/8" Ø 1.0 mm	
4315	HMI-SI-4414	Vascular Dilators Cooley St 19 cm / 7 4/8" Ø 1.5 mm	
4316	HMI-SI-4415	Vascular Dilators Cooley Ti 19 cm / 7 4/8" Ø 0.5 mm	



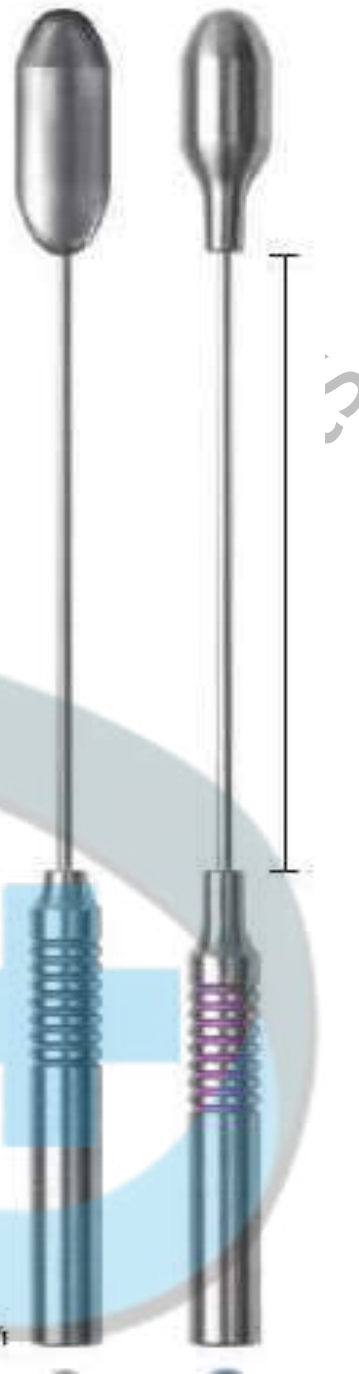

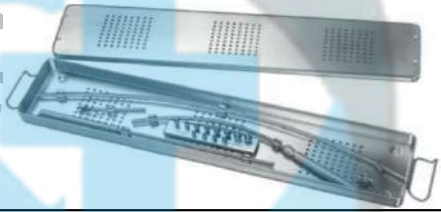



4317	HMI-SI-4416	Vascular Dilators Cooley Ti 19 cm / 7 4/8" Ø 1.0 mm
4318	HMI-SI-4417	Vascular Dilators Cooley Ti 19 cm / 7 4/8" Ø 1.5 mm
4319	HMI-SI-4418	Vascular Dilators Cooley St 14 cm / 5 4/8" Ø 2.0 mm
4320	HMI-SI-4419	Vascular Dilators Cooley St 14 cm / 5 4/8" Ø 2.5 mm
4321	HMI-SI-4419(a)	Vascular Dilators Cooley St 14 cm / 5 4/8" Ø 3 mm
4322	HMI-SI-4420	Vascular Dilators Cooley Ti 14 cm / 5 4/8" Ø 2 mm
4323	HMI-SI-4421	Vascular Dilators Cooley Ti 14 cm / 5 4/8" Ø 2.5 mm
4324	HMI-SI-4422	Vascular Dilators Cooley Ti 14 cm / 5 4/8" Ø 3 mm
4325	HMI-SI-4423	Vascular Dilators Cooley St 19 cm / 7 4/8" Ø 2 mm
4326	HMI-SI-4424	Vascular Dilators Cooley St 19 cm / 7 4/8" Ø 2.5 mm
4327	HMI-SI-4425	Vascular Dilators Cooley St 19 cm / 7 4/8" Ø 3 mm
4328	HMI-SI-4426	Vascular Dilators Cooley Ti 19 cm / 7 4/8" Ø 2 mm
4329	HMI-SI-4427	Vascular Dilators Cooley Ti 19 cm / 7 4/8" Ø 2.5 mm
4330	HMI-SI-4428	Vascular Dilators Cooley Ti 19 cm / 7 4/8" Ø 3 mm
4331	HMI-SI-4429	Vascular Dilators DeBakey St 14 cm / 5 4/8" Ø 0.5 mm
4332	HMI-SI-4430	Vascular Dilators DeBakey St 14 cm / 5 4/8" Ø 1.0 mm
4333	HMI-SI-4431	Vascular Dilators DeBakey St 14 cm / 5 4/8" Ø 1.5 mm
4334	HMI-SI-4432	Vascular Dilators DeBakey St 14 cm / 5 4/8" Ø 2.0 mm
4335	HMI-SI-4433	Vascular Dilators DeBakey Ti 14 cm / 5 4/8" Ø 0.5 mm
4336	HMI-SI-4434	Vascular Dilators DeBakey Ti 14 cm / 5 4/8" Ø 1.0 mm











4337	HMI-SI-4435	Vascular Dilators DeBakey Ti 14 cm / 5 4/8" Ø1.5 mm
4338	HMI-SI-4436	Vascular Dilators DeBakey Ti 14 cm / 5 4/8" Ø2.0 mm
4339	HMI-SI-4437	Vascular Dilators DeBakey St 19 cm / 7 4/8" Ø0.5 mm
4340	HMI-SI-4438	Vascular Dilators DeBakey St 19 cm / 7 4/8" Ø1.0 mm
4341	HMI-SI-4439	Vascular Dilators DeBakey St 19 cm / 7 4/8" Ø1.5 mm
4342	HMI-SI-4440	Vascular Dilators DeBakey St 19 cm / 7 4/8" Ø2.0 mm
4343	HMI-SI-4441	Vascular Dilators DeBakey Ti 19 cm / 7 4/8" Ø0.5 mm
4344	HMI-SI-4442	Vascular Dilators DeBakey Ti 19 cm / 7 4/8" Ø1.0 mm
4345	HMI-SI-4443	Vascular Dilators DeBakey Ti 19 cm / 7 4/8" Ø1.5 mm
4346	HMI-SI-4444	Vascular Dilators DeBakey Ti 19 cm / 7 4/8" Ø2.0 mm
4347	HMI-SI-4445	Vascular Dilators DeBakey St 14 cm / 5 4/8" Ø2.5 mm
4348	HMI-SI-4446	Vascular Dilators DeBakey St 14 cm / 5 4/8" Ø3.0 mm
4349	HMI-SI-4447	Vascular Dilators DeBakey St 14 cm / 5 4/8" Ø3.5 mm
4350	HMI-SI-4448	Vascular Dilators DeBakey St 14 cm / 5 4/8" Ø4.0 mm
4351	HMI-SI-4449	Vascular Dilators DeBakey Ti 14 cm / 5 4/8" Ø2.5 mm
4352	HMI-SI-4450	Vascular Dilators DeBakey Ti 14 cm / 5 4/8" Ø3.0 mm
4353	HMI-SI-4451	Vascular Dilators DeBakey Ti 14 cm / 5 4/8" Ø3.5 mm
4354	HMI-SI-4452	Vascular Dilators DeBakey Ti 14 cm / 5 4/8" Ø4.0 mm
4355	HMI-SI-4453	Vascular Dilators DeBakey St 19 cm / 7 4/8" Ø2.5 mm
4356	HMI-SI-4454	Vascular Dilators DeBakey St 19 cm / 7 4/8" Ø3.0 mm
4357	HMI-SI-4455	Vascular Dilators DeBakey St 19 cm / 7 4/8" Ø3.5 mm
4358	HMI-SI-4456	Vascular Dilators DeBakey St 19 cm / 7 4/8" Ø4.0 mm
4359	HMI-SI-4457	Vascular Dilators DeBakey Ti 19 cm / 7 4/8" Ø2.5 mm
4360	HMI-SI-4458	Vascular Dilators DeBakey Ti 19 cm / 7 4/8" Ø3.0 mm
4361	HMI-SI-4459	Vascular Dilators DeBakey Ti 19 cm / 7 4/8" Ø3.5 mm













4362	HMI-SI-4460	Vascular Dilators DeBakey Ti 19 cm / 7 4/8" Ø4.0 mm	
4363	HMI-SI-4461	Vascular Dilators DeBakey St 14 cm / 5 4/8" Ø4.5 mm	
4364	HMI-SI-4462	Vascular Dilators DeBakey St 14 cm / 5 4/8" Ø5.0 mm	
4365	HMI-SI-4463	Vascular Dilators DeBakey Ti 14 cm / 5 4/8" Ø4.5 mm	
4366	HMI-SI-4464	Vascular Dilators DeBakey Ti 14 cm / 5 4/8" Ø5.0 mm	
4367	HMI-SI-4465	Vascular Dilators DeBakey St 19 cm / 7 4/8" Ø4.5 mm	
4368	HMI-SI-4466	Vascular Dilators DeBakey St 19 cm / 7 4/8" Ø5.0 mm	
4369	HMI-SI-4467	Vascular Dilators DeBakey St 19 cm / 7 4/8" Ø7.0 mm	
4370	HMI-SI-4468	Vascular Dilators DeBakey St 19 cm / 7 4/8" Ø9.0 mm	
4371	HMI-SI-4469	Vascular Dilators DeBakey Ti 19 cm / 7 4/8" Ø4.5 mm	
4372	HMI-SI-4470	Vascular Dilators DeBakey Ti 19 cm / 7 4/8" Ø5.0 mm	
4373	HMI-SI-4471	Vascular Dilators DeBakey Ti 19 cm / 7 4/8" Ø7.0 mm	
4374	HMI-SI-4472	Vascular Dilators DeBakey Ti 19 cm / 7 4/8" Ø9.0 mm	
4375	HMI-SI-4473	Tunneling Set Martin complete set with 3 shafts, 2 handles and 12 tips in storage case	
4376	HMI-SI-4474	Tunneling Set Martin Vein Tip	
4377	HMI-SI-4475	Tunneling Set Martin Luer Adaptor Luer-Lock cone	
4378	HMI-SI-4476	Tunneling Set Martin 10 cm / 4" Wrench	

4379	HMI-SI-4477	Tunneling Set Martin 12,5 cm / 5" Universal Handle	
4380	HMI-SI-4478	Tunneling Set Martin 24,5 cm Tunneling Shaft Curved	
4381	HMI-SI-4479	Tunneling Set Martin 24,5 cm Tunneling Shaft Straight	
4382	HMI-SI-4480	Tunneling Set Martin 55,5 cm Tunneling Shaft Curved	
4383	HMI-SI-4481	Tunneling Set Martin Screw Olive Ø 5 mm	
4384	HMI-SI-4482	Tunneling Set Martin Screw Olive Ø 6 mm	
4385	HMI-SI-4483	Tunneling Set Martin Screw Olive Ø 7 mm	
4386	HMI-SI-4484	Tunneling Set Martin Screw Olive Ø 8 mm	

4387	HMI-SI-4485	Tunneling Set Martin Screw Olive Ø 10 mm	
4388	HMI-SI-4486	Tunneling Set Martin Screw Olive Ø 12 mm	
4389	HMI-SI-4487	Tunneling Set Martin Plate for Tips	
4390	HMI-SI-4488	Tunneling Set Martin Metal Case 55 x 11,5 x 3,5 cm	
4391	HMI-SI-4489	Fasciotomy Knife, Fasciotomy Spatulas Hach 30 cm / 11 6/8"	
4392	HMI-SI-4491	Fasciotomy Knife, Fasciotomy Spatulas Hach 30 cm / 11 6/8" 25 mm	
4393	HMI-SI-4492	Fasciotomy Knife, Fasciotomy Spatulas Hach 30 cm / 11 6/8" 32 mm	
4394	HMI-SI-4493	Fasciotomy Knife, Fasciotomy Spatulas Hach 30 cm / 11 6/8" 40 mm	



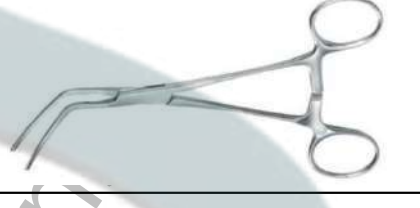





4395	HMI-SI-4494	Fasciotomy Knife, Fasciotomy Spatulas Hach 30 cm / 11 6/8" 52 mm	
4396	HMI-SI-4495	Intima Spatulas, Vascular Dissectors 18,5 cm / 7 2/8" 3 mm	
4397	HMI-SI-4496	Intima Spatulas, Vascular Dissectors 21,5 cm / 8 4/8" 3 mm	
4398	HMI-SI-4497	Intima Spatulas, Vascular Dissectors 14 cm / 5 4/8" 4 mm	
4399	HMI-SI-4498	Intima Spatulas, Vascular Dissectors 23,5 cm / 9 2/8" 5,5 mm	
4400	HMI-SI-4499	Intima Spatulas, Vascular Dissectors Robb 24 cm / 9 4/8" Ø2,5 mm	
4401	HMI-SI-4500	Intima Spatulas, Vascular Dissectors Robb 24 cm / 9 4/8" Ø2,0mm	
4402	HMI-SI-4501	Intima Spatulas, Vascular Dissectors Robb 24 cm / 9 4/8" Ø 1,5 mm	



4403	HMI-SI-4502	Intima Spatulas, Vascular Dissectors Robb 24 cm / 9 4/8" Ø 1,0 mm	
4404	HMI-SI-4503	Nerve Hooklets, Tourniquets Crile 20 cm / 7 7/8" Ø 1,4 mm 90°	
4405	HMI-SI-4504	Nerve Hooklets, Tourniquets Crile 20,5 cm / 8 1/8" Ø 1,4 mm 30°	
4406	HMI-SI-4506	Nerve Hooklets, Tourniquets 26 cm / 10 2/8" Ø 1,5 mm	
4407	HMI-SI-4507	Nerve Hooklets, Tourniquets 26 cm / 10 2/8" Ø 2,0 mm	
4408	HMI-SI-4508	Nerve Hooklets, Tourniquets 26 cm / 10 2/8" Ø 2,5 mm	
4409	HMI-SI-4509	Nerve Hooklets, Tourniquets 26 cm / 10 2/8" Ø 3,0 mm	
4410	HMI-SI-4510	Nerve Hooklets, Tourniquets Rumel-Belmont 27 cm / 10 5/8" Ø 4,2 mm	
			



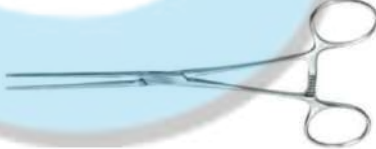



4411	HMI-SI-4511	Nerve Hooklets, Tourniquets Rumel-Belmont 30,5 cm / 12" Ø 8,8 mm	
4412	HMI-SI-4512	Pediatric Aortic Clamps, Pediatric Vascular Clamps Atrauma Subramanian-Miniature 16 cm / 6 2/8"	
4413	HMI-SI-4513	Pediatric Aortic Clamps, Pediatric Vascular Clamps Atrauma Subramanian 16 cm / 6 2/8"	
4414	HMI-SI-4514	Pediatric Aortic Clamps, Pediatric Vascular Clamps Atrauma Subramanian 16 cm / 6 2/8"	
4415	HMI-SI-4515	Pediatric Vascular Clamps Atrauma De Bakey baby 14 cm / 5 4/8"	
4416	HMI-SI-4516	Pediatric Vascular Clamps Atrauma De Bakey baby 14 cm / 5 4/8"	
4417	HMI-SI-4517	Pediatric Vascular Clamps Atrauma De Bakey baby 14 cm / 5 4/8"	
4418	HMI-SI-4518	Pediatric Vascular Clamps Atrauma De Bakey baby 14 cm / 5 4/8"	
4419	HMI-SI-4519	Pediatric Vascular Clamps Atrauma De Bakey baby 14 cm / 5 4/8"	
4420	HMI-SI-4520	Pediatric Vascular Clamps Atrauma De Bakey baby 13 cm / 5"	
4421	HMI-SI-4521	Pediatric Vascular Clamps Atrauma De Bakey baby 13 cm / 5"	
4422	HMI-SI-4522	Pediatric Vascular Clamps Atrauma De Bakey baby 14 cm / 5 4/8"	

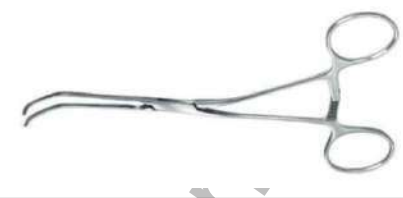
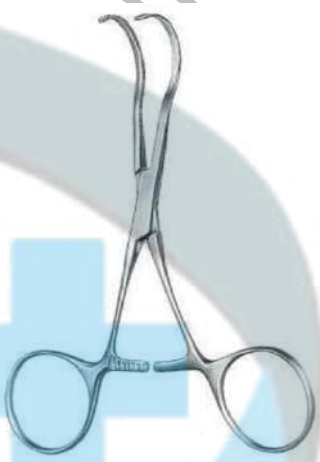
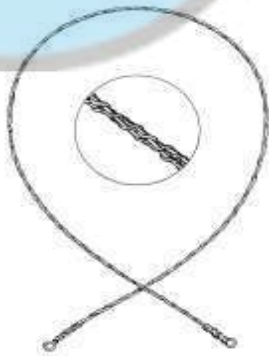







4423	HMI-SI-4523	Pediatric Vascular Clamps Atrauma De Bakey baby 13 cm / 5"
4424	HMI-SI-4524	Pediatric Vascular Clamps Atrauma De Bakey baby 14 cm / 5 4/8"
4425	HMI-SI-4525	Pediatric Vascular Clamps Atrauma De Bakey baby 14 cm / 5 4/8"
4426	HMI-SI-4526	Pediatric Vascular Clamps Atrauma De Bakey baby 14 cm / 5 4/8"
4427	HMI-SI-4527	Pediatric Vascular Clamps Atrauma De Bakey baby 14 cm / 5 4/8"
4428	HMI-SI-4528	Pediatric Vascular Clamps Atrauma De Bakey baby 14 cm / 5 4/8"
4429	HMI-SI-4529	Pediatric Vascular Clamps Atrauma De Bakey baby 14 cm / 5 4/8"
4430	HMI-SI-4530	Pediatric Vascular Clamps Atrauma De Bakey delicate serration St 13,5 cm / 5 3/8"
4431	HMI-SI-4531	Pediatric Vascular Clamps Atrauma De Bakey delicate serration St 13 cm / 5 1/8"
4432	HMI-SI-4532	Pediatric Vascular Clamps Atrauma De Bakey delicate serration St 10,5 cm / 4 1/8"
4433	HMI-SI-4533	Pediatric Vascular Clamps Atrauma De Bakey delicate serration Ti 13,5 cm / 5 3/8"
4434	HMI-SI-4534	Pediatric Vascular Clamps Atrauma De Bakey delicate serration Ti 13 cm / 5 1/8"
4435	HMI-SI-4535	Pediatric Vascular Clamps Atrauma De Bakey delicate serration Ti 10,5 cm / 4 1/8"
4436	HMI-SI-4536	Pediatric Vascular Clamps Atrauma De Bakey delicate serration St 12 cm / 4 6/8"
4437	HMI-SI-4537	Pediatric Vascular Clamps Atrauma De Bakey delicate serration St 13 cm / 5 1/8"
4438	HMI-SI-4538	Pediatric Vascular Clamps Atrauma De Bakey delicate serration Ti 12 cm / 4 6/8"











4439	HMI-SI-4539	Pediatric Vascular Clamps Atrauma De Bakey delicate serration Ti 13 cm / 5 1/8"	
4440	HMI-SI-4540	Neonatal Vascular Clamps Atrauma finoLine De Bakey very delicate serration 10,5 cm / 4 1/8"	
4441	HMI-SI-4541	Neonatal Vascular Clamps Atrauma finoLine De Bakey very delicate serration 10,5 cm / 4 1/8"	
4442	HMI-SI-4542	Neonatal Vascular Clamps Atrauma finoLine De Bakey very delicate serration 10,5 cm / 4 1/8"	
4443	HMI-SI-4543	Neonatal Vascular Clamps Atrauma finoLine De Bakey very delicate serration 10,5 cm / 4 1/8"	
4444	HMI-SI-4544	Neonatal Vascular Clamps Atrauma finoLine De Bakey very delicate serration 10,5 cm / 4 1/8"	
4445	HMI-SI-4545	Pediatric Vascular Clamps Atrauma De Bakey baby 16,5 cm / 6 4/8"	
4446	HMI-SI-4546	Pediatric Vascular Clamps Atrauma De Bakey baby 16,5 cm / 6 4/8"	



4447	HMI-SI-4547	Pediatric Vascular Clamps Atrauma De Bakey baby 15,5 cm / 6"	
4448	HMI-SI-4548	Pediatric Vascular Clamps Atrauma De Bakey baby 15,5 cm / 6"	
4449	HMI-SI-4549	Pediatric Vascular Clamps Atrauma De Bakey baby 16 cm / 6 2/8"	
4450	HMI-SI-4550	Pediatric Vascular Clamps Castañeda 13 cm / 4 1/8"	
4451	HMI-SI-4551	Pediatric Vascular Clamps Castañeda 12,5 cm / 5"	
4452	HMI-SI-4552	Pediatric Vascular Clamps Castañeda 12 cm / 4 6/8"	
4453	HMI-SI-4553	Pediatric Vascular Clamps Castañeda 11 cm / 4 2/8"	
4454	HMI-SI-4554	Pediatric Vascular Clamps Castañeda 12 cm / 4 6/8"	
4455	HMI-SI-4555	Pediatric Vascular Clamps Castañeda 12 cm / 4 6/8"	
4456	HMI-SI-4556	Pediatric Vascular Clamps Castañeda 12 cm / 4 6/8"	
4457	HMI-SI-4557	Pediatric Vascular Clamps Castañeda 12 cm / 4 6/8"	
4458	HMI-SI-4429(a)	Wire Saws Gigli 30 cm / 11 6/8"	
4459	HMI-SI-4430(a)	Wire Saws Gigli 40 cm / 15 6/8"	
4460	HMI-SI-4431(a)	Wire Saws Gigli 50 cm / 19 5/8"	
4461	HMI-SI-4432(a)	Wire Saws Gigli 60 cm / 23 5/8"	
4462	HMI-SI-4433(a)	Wire Saws Gigli 70 cm / 27 4/8"	





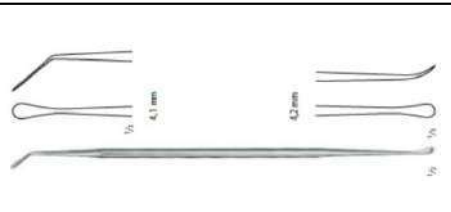
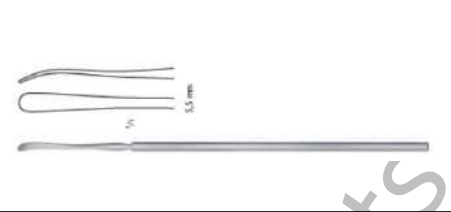
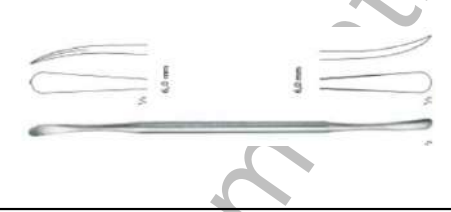
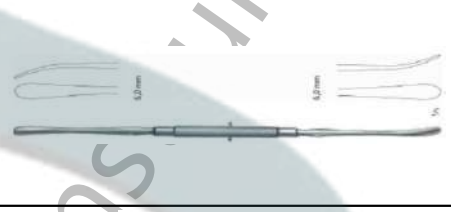
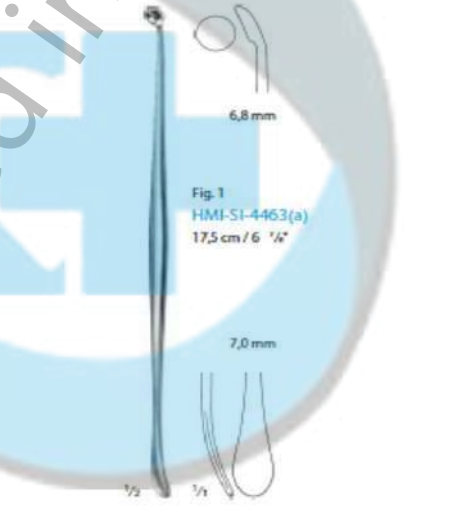

4463	HMI-SI-4434(a)	Wire Saws Gigli Wire saw handle	
4464	HMI-SI-4435(a)	Wire Saws De Martel 33 cm / 13" Wire saw guide	
4465	HMI-SI-4436(a)	Skull Traction Tongs Crutchyeld small pattern	
4466	HMI-SI-4437(a)	Skull Traction Tongs Crutchyeld medium pattern	
4467	HMI-SI-4438(a)	Skull Traction Tongs 7 cm / 2 6/8" Drill Point Ø 3,5 mm	
4468	HMI-SI-4439(a)	Skull Traction Tongs 7 cm / 2 6/8" Drill Point Ø 5 mm	
4469	HMI-SI-4440(a)	Skull Traction Tongs large pattern	
4470	HMI-SI-4441(a)	Skull Traction Tongs Spare Pin	

4471	HMI-SI-4442(a)	Cranial Rongeurs Dahlgren 19,5 cm / 7 5/8" with 3 hooks	
4472	HMI-SI-4443(a)	Cranial Rongeurs De Vilbiss 21 cm / 8 2/8" with 2 hooks	
4473	HMI-SI-4444(a)	Cranial Rongeurs Cone 22,5 cm / 8 7/8" Cranial Punch	
4474	HMI-SI-4445(a)	Clips and Applying Forceps Olivecrona-Toennis Clip Applying Forceps	
4475	HMI-SI-4446(a)	Clips and Applying Forceps McKenzie 18,5 cm / 7 2/8" Clip Applying Forceps	
4476	HMI-SI-4447(a)	Clips and Applying Forceps Kölner Scalp Clip SU = 50/pack	
4477	HMI-SI-4448(a)	Clips and Applying Forceps Raney Scalp Clip	
4478	HMI-SI-4449(a)	Clips and Applying Forceps 15,5 cm / 6" Applying/Removal Forceps	

4479	HMI-SI-4450(a)	Dissectors Yasargil Galea hook 30 cm / 11 6/8"	
4480	HMI-SI-4451(a)	Dissectors Yasargil Galea hook 41 cm / 16 1/8"	
4481	HMI-SI-4453(a)	Dissectors Toennis 24 cm / 9 4/8"	
4482	HMI-SI-4454(a)	Dissectors Olivecrona 24 cm / 9 4/8"	
4483	HMI-SI-4455(a)	Dissectors Olivecrona 18 cm / 7 1/8"	
4484	HMI-SI-4456(a)	Dissectors Olivecrona 24 cm / 9 4/8"	
4485	HMI-SI-4457(a)	Dissectors Olivecrona 20 cm / 7 7/8"	
4486	HMI-SI-4458(a)	Dissectors Sachs 20,5 cm / 8 1/8"	





4487	HMI-SI-4459(a)	Dissectors Milligan 22 cm / 8 5/8"	
4488	HMI-SI-4460(a)	Dissectors Davis 21,5 cm / 8 4/8"	
4489	HMI-SI-4461(a)	Dissectors 22 cm / 8 5/8"	
4490	HMI-SI-4462(a)	Dissectors Davis 24,5 cm / 9 5/8"	
4491	HMI-SI-4463(a)	Dissectors Penyeld 17,5 cm / 6 7/8"	 <p>Fig.1 HMI-SI-4463(a) 17,5 cm / 6 7/8"</p>
4492	HMI-SI-4464(a)	Dissectors Penyeld 19,5 cm / 7 5/8"	
4493	HMI-SI-4465(a)	Dissectors Penyeld 19,5 cm / 7 5/8"	
4494	HMI-SI-4466(a)	Dissectors Penyeld 20,5 cm / 8 1/8"	
4495	HMI-SI-4467(a)	Dissectors Penyeld 18,5 cm / 7 2/8"	
4496	HMI-SI-4468(a)	Self-Retaining Retractors, for Skull Mounting Leyla Self-retaining brain retractor with 1 ,exible arm, complete	



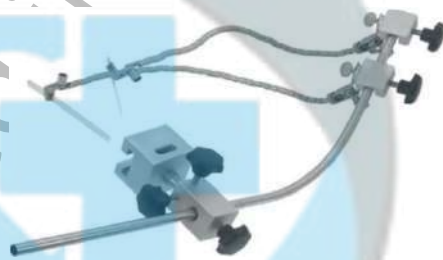

4497	HMI-SI-4469(a)	Self-Retaining Retractors, for Skull Mounting Leyla Self-retaining brain retractor with 1 flexible arm, complete, consisting of: Flexible arm	
4498	HMI-SI-4470(a)	Self-Retaining Retractors, for Skull Mounting Leyla Self-retaining brain retractor with 1 flexible arm, complete, consisting of: Fixation base for 1 arm	
4499	HMI-SI-4471(a)	Self-Retaining Retractors, for Skull Mounting Leyla Self-retaining brain retractor with 1 flexible arm, complete, consisting of: Support for flat brain spatulas	
4500	HMI-SI-4472(a)	Self-Retaining Retractors, for Skull Mounting Leyla Self-retaining brain retractor with 2 flexible arm, complete	
4501	HMI-SI-4473(a)	Self-Retaining Retractors, for Skull Mounting Leyla Self-retaining brain retractor with 2 flexible arm, complete, consisting of: Flexible arm	
4502	HMI-SI-4474(a)	Self-Retaining Retractors, for Skull Mounting Leyla Self-retaining brain retractor with 1 flexible arm, complete, consisting of: Fixation base for 1 arm	
4503	HMI-SI-4475(a)	Self-Retaining Retractors, for Skull Mounting Leyla Self-retaining brain retractor with 1 flexible arm, complete, consisting of: Support for flat brain spatulas	
4504	HMI-SI-4476(a)	Accessories for Leyla Self Retaining Retractors Leyla Flexible arm for attaching coupling heads and fixation bases	
			







4505	HMI-SI-4477(a)	Accessories for Leyla Self Retaining Retractors Leyla Fixation base for 1 adjustable arm, for skull mounting	
4506	HMI-SI-4478(a)	Accessories for Leyla Self Retaining Retractors Leyla Fixation base for 2 adjustable arms, for skull mounting	
4507	HMI-SI-4479(a)	Accessories for Leyla Self Retaining Retractors Leyla Fixation base for 1 adjustable arm, for mounting to bars up to Ø 16 mm	
4508	HMI-SI-4480(a)	Accessories for Leyla Self Retaining Retractors Leyla Support for brain spatulas with round shaft up to Ø 5.5 mm, fixation to adjustable arm	
4509	HMI-SI-4481(a)	Accessories for Leyla Self Retaining Retractors Leyla Support for flat brain spatulas, fixation to adjustable arm	
4510	HMI-SI-4481(b)	Self-Retaining Retractors, Fixation to Operating Table Leyla Self-retaining brain retractor with 1 adjustable arm, complete	
4511	HMI-SI-4482(a)	Self-Retaining Retractors, Fixation to Operating Table Leyla Self-retaining brain retractor with 1 adjustable arm, complete, consisting of: Ball and socket joint	
4512	HMI-SI-4483(a)	Self-Retaining Retractors, Fixation to Operating Table Leyla Self-retaining brain retractor with 1 adjustable arm, complete, consisting of: Holding rod	





4513	HMI-SI-4484(a)	Self-Retaining Retractors, Fixation to Operating Table Leyla Self-retaining brain retractor with 1 flexible arm, complete, consisting of: Coupling head
4514	HMI-SI-4485(a)	Self-Retaining Retractors, Fixation to Operating Table Leyla Self-retaining brain retractor with 1 flexible arm, complete, consisting of: Flexible arm
4515	HMI-SI-4485(b)	Self-Retaining Retractors, Fixation to Operating Table Leyla Self-retaining brain retractor with 1 flexible arm, complete, consisting of: Support, for brain spatulas with round shaft
4516	HMI-SI-4486(a)	Self-Retaining Retractors, Fixation to Operating Table Leyla Self-retaining brain retractor with 2 flexible arms, complete
4517	HMI-SI-4487(a)	Self-Retaining Retractors, Fixation to Operating Table Leyla Self-retaining brain retractor with 2 flexible arms, complete consisting of: Ball and socket joint
4518	HMI-SI-4488(a)	Self-Retaining Retractors, Fixation to Operating Table Leyla Self-retaining brain retractor with 2 flexible arms, complete consisting of: Holding rod
4519	HMI-SI-4489(a)	Self-Retaining Retractors, Fixation to Operating Table Leyla Self-retaining brain retractor with 2 flexible arms, complete consisting of: Coupling heads
4520	HMI-SI-4490(a)	Self-Retaining Retractors, Fixation to Operating Table Leyla Self-retaining brain retractor with 2 flexible arms, complete consisting of: Flexible arms











4521	HMI-SI-4491(a)	Self-Retaining Retractors, Fixation to Operating Table Leyla Self-retaining brain retractor with 2 flexible arms, complete consisting of: Support, for flat brain spatulas	
4522	HMI-SI-4492(a)	Self-Retaining Retractors, Fixation to Operating Table Leyla Self-retaining brain retractor with 2 flexible arms, complete consisting of: Support, for brain spatulas with round shaft	
4523	HMI-SI-4493(a)	Accessories for Leyla Retractors Leyla Ball and socket joint, for fixation of holding rod to pole of operating table	
4524	HMI-SI-4494(a)	Accessories for Leyla Retractors Leyla Holding rod for fixation in ball and socket joint and to take coupling heads	
4525	HMI-SI-4495(a)	Accessories for Leyla Retractors Leyla Coupling head to take 1-5 flexible arms	
4526	HMI-SI-4496(a)	Accessories for Leyla Retractors Leyla Coupling head, turnable, can be fixed in any position, to take 1 flexible arm	
4527	HMI-SI-4497(a)	Spatulas Heifetz malleable 155 x 8 mm	
4528	HMI-SI-4498(a)	Spatulas Heifetz malleable 155 x 11 mm	
4529	HMI-SI-4499(a)	Spatulas Heifetz malleable 155 x 14 mm	
4530	HMI-SI-4500(a)	Spatulas Heifetz malleable 155 x 17 mm	

4531	HMI-SI-4501(a)	Spatulas Heifetz malleable 200 x 14 mm	
4532	HMI-SI-4502(a)	Spatulas Heifetz malleable 200 x 17 mm	
4533	HMI-SI-4503(a)	Spatulas Heifetz malleable 200 x 20 mm	
4534	HMI-SI-4504(a)	Hooks Groningen 26,5 cm / 10 3/8" Ø 2,4 mm 90°	
4535	HMI-SI-4505(a)	Hooks Groningen 26,5 cm / 10 3/8" Ø 2,4 mm	
4536	HMI-SI-4506(a)	Hooks Cushing 19 cm / 7 4/8" Ø 1,0 mm 90°	
4537	HMI-SI-4507(a)	Hooks Cushing 28 cm / 11" Ø 1,0 mm 90°	
4538	HMI-SI-4508(a)	Hooks Cushing 19 cm / 7 4/8" Ø 1,6 mm 90°	

4539	HMI-SI-4509(a)	Hooks Cushing 28 cm / 11" Ø 1,6 mm 90°	
4540	HMI-SI-4510(a)	Hooks Smithwick 16,5 cm / 6 4/8" Ø 1,0 mm	
4541	HMI-SI-4511(a)	Hooks Smithwick 21 cm / 8 4/8" Ø 1,0 mm	
4542	HMI-SI-4512(a)	Hooks Adson 20 cm / 7 7/8" blunt	
4543	HMI-SI-4513(a)	Hooks Adson 20 cm / 7 7/8" sharp	
4544	HMI-SI-4514(a)	Hooks Graham 16,5 cm / 6 4/8"	
4545	HMI-SI-4515(a)	Hooks Sachs 17 cm / 6 6/8"	
4546	HMI-SI-4516(a)	Hooks 19 cm / 7 4/8" Micro hooklet 1,4 mm 90°	



4547	HMI-SI-4517(a)	Hooks 19 cm / 7 4/8" Micro hooklet 2,5 mm 90°	
4548	HMI-SI-4518(a)	Hooks Frazier 13 cm / 5 1/8"	
4549	HMI-SI-4519(a)	Hooks Frazier 18 cm / 7 1/8"	
4550	HMI-SI-4520(a)	Micro Scissors Vannas 12 cm / 4 6/8" 9 mm	
4551	HMI-SI-4521(a)	Micro Scissors Vannas 12 cm / 4 6/8" 12 mm	
4552	HMI-SI-4522(a)	Micro Scissors Vannas 12 cm / 4 6/8" 12 mm	
4553	HMI-SI-4523(a)	Micro Scissors Vannas 16 cm / 6 2/8" 12 mm	
4554	HMI-SI-4524(a)	Micro Scissors Vannas 16 cm / 6 2/8" 12 mm	



4555	HMI-SI-4525(a)	Micro Scissors Millesi 16 cm / 6 2/8" 12 mm	
4556	HMI-SI-4526(a)	Micro Scissors Millesi 16 cm / 6 2/8" 12 mm	
4557	HMI-SI-4527(a)	Micro Scissors Jacobson 18,5 cm / 7 2/8" 12 mm	
4558	HMI-SI-4528(a)	Micro Scissors Yasargil 16,5 cm / 6 4/8"	
4559	HMI-SI-4529(a)	Micro Scissors Yasargil 16,5 cm / 6 4/8"	
4560	HMI-SI-4530(a)	Micro Scissors Yasargil 20 cm / 7 7/8"	
4561	HMI-SI-4531(a)	Micro Scissors Yasargil 20 cm / 7 7/8"	
4562	HMI-SI-4532(a)	Micro Scissors Yasargil 20 cm / 7 7/8"	
4563	HMI-SI-4534(a)	Micro Scissors Yasargil 20 cm / 7 7/8"	
4564	HMI-SI-4535(a)	Micro Scissors Yasargil 20 cm / 7 7/8"	
4565	HMI-SI-4536(a)	Micro Scissors Yasargil 22,5 cm / 8 7/8" 15 mm	
4566	HMI-SI-4537(a)	Micro Scissors Yasargil 22,5 cm / 8 7/8" 15 mm	
4567	HMI-SI-4538(a)	Micro Scissors Yasargil 22,5 cm / 8 7/8"	



4568	HMI-SI-4539(a)	Micro Scissors Yasargil 22,5 cm / 8 7/8"	
4569	HMI-SI-4540(a)	Micro Scissors Yasargil 24,5 cm / 9 5/8"	
4570	HMI-SI-4541(a)	Micro Scissors Nagel 20 cm / 7 7/8" 45° 14 mm	
4571	HMI-SI-4542(a)	Micro Scissors Nagel 20 cm / 7 7/8" 45° 14 mm	
4572	HMI-SI-4543(a)	Micro Scissors Nagel 20 cm / 7 7/8" 135° 14 mm	
4573	HMI-SI-4544(a)	Micro Scissors Fahlbusch 16,5 cm / 6 4/8"	
4574	HMI-SI-4545(a)	Micro Scissors Caspar 11,5 cm / 4 4/8"	
4575	HMI-SI-4546(a)	Micro Forceps Jacobson 18 cm / 7 1/8" w/o ratchet	
4576	HMI-SI-4547(a)	Micro Forceps Jacobson 18 cm / 7 1/8" with ratchet	







4577	HMI-SI-4548(a)	Micro Forceps Yasargil 20 cm / 7 7/8"	
4578	HMI-SI-4549(a)	Micro Forceps Yasargil 20 cm / 7 7/8"	
4579	HMI-SI-4550(a)	Micro Forceps Yasargil 22,5 cm / 8 7/8"	
4580	HMI-SI-4551(a)	Micro Forceps Yasargil 22,5 cm / 8 7/8"	
4581	HMI-SI-4552(a)	Micro Forceps 23 cm / 9" 23 cm / 9" 3.0 mm	
4582	HMI-SI-4553(a)	Micro Forceps 23 cm / 9" 23 cm / 9" 3.0 mm	
4583	HMI-SI-4554(a)	Micro Forceps 24 cm / 9 4/8" 3.0 mm	
4584	HMI-SI-4555(a)	Micro Forceps 24 cm / 9 4/8" 5.0 mm	
4585	HMI-SI-4556(a)	Micro Forceps 24 cm / 9 4/8" 7.0 mm	
4586	HMI-SI-4557(a)	Micro Forceps 16,5 cm / 6 4/8" 3.0 mm	
4587	HMI-SI-4558	Micro Forceps 16,5 cm / 6 4/8" 5.0 mm	
4588	HMI-SI-4559	Micro Forceps 20 cm / 7 7/8" 3.0 mm	
4589	HMI-SI-4560	Micro Forceps 20 cm / 7 7/8" 3.0 mm	
4590	HMI-SI-4561	Micro Forceps 22 cm / 8 5/8" 3.0 mm	
4591	HMI-SI-4562	Micro Forceps 22 cm / 8 5/8" 5.0 mm	
4592	HMI-SI-4563	Micro Forceps 22 cm / 8 5/8" 3.0 mm	
4593	HMI-SI-4564	Micro Forceps 22 cm / 8 5/8" 5.0 mm	
4594	HMI-SI-4565	Micro Forceps 22 cm / 8 5/8" 3.0 mm	
4595	HMI-SI-4566	Micro Forceps 22 cm / 8 5/8" 5.0 mm	
4596	HMI-SI-4567	Micro Forceps 22 cm / 8 5/8" 3.0 mm 45°	



4597	HMI-SI-4568	Micro Forceps 22 cm / 8 5/8" 3.0 mm 90°	
4598	HMI-SI-4569	Micro Forceps 22 cm / 8 5/8" 3.0 mm	
4599	HMI-SI-4570	Micro Forceps 22 cm / 8 5/8" 5.0 mm	
4600	HMI-SI-4571	Micro Forceps 18 cm / 7 1/8" 0.6mm	
4601	HMI-SI-4572	Micro Forceps 18 cm / 7 1/8" 0.9mm	
4602	HMI-SI-4573	Micro Forceps 18 cm / 7 1/8"	
4603	HMI-SI-4574	Micro Forceps 20 cm / 7 7/8" 0.6mm	
4604	HMI-SI-4575	Micro Forceps 20 cm / 7 7/8" 0.9mm	
4605	HMI-SI-4576	Micro Forceps 22 cm / 8 5/8" 0.6mm	
4606	HMI-SI-4577	Micro Forceps 22 cm / 8 5/8" 0.9mm	
4607	HMI-SI-4578	Micro Forceps 24 cm / 9 4/8" 0.6mm	
4608	HMI-SI-4579	Micro Forceps 24 cm / 9 4/8" 0.9mm	
4609	HMI-SI-4580	Micro Forceps Hunt 20 cm / 7 7/8" angled	
4610	HMI-SI-4581	Micro Forceps Hunt 20 cm / 7 7/8" bayonet	
4611	HMI-SI-4582	Micro instruments Yasargil Tumor fork 8 mm	
4612	HMI-SI-4583	Micro instruments Yasargil Tumor fork 5 mm	
4613	HMI-SI-4584	Micro instruments Samii 23 cm / 9" Tumor knife 1,0mm	





4614	HMI-SI-4585	Micro instruments Samii 23 cm / 9" Tumor knife 1,5mm	
4615	HMI-SI-4586	Micro instruments Samii 23 cm / 9" Tumor knife 1,5mm	
4616	HMI-SI-4587	Micro instruments Samii 23 cm / 9" Tumor knife 2,0mm	
4617	HMI-SI-4588	Micro instruments Samii 23 cm / 9" Tumor knife 2,5mm	
4618	HMI-SI-4589	Micro instruments Samii 23 cm / 9" Tumor knife 3,0mm	
4619	HMI-SI-4590	Micro instruments Samii 23 cm / 9" Tumor knife 3,0mm	
4620	HMI-SI-4591	Micro instruments Samii 23 cm / 9" Tumor knife 3,5mm	
4621	HMI-SI-4592	Micro instruments Samii 23 cm / 9" Tumor knife 4,0mm	
4622	HMI-SI-4593	Micro instruments Samii 23 cm / 9" Tumor knife 4,5mm	
4623	HMI-SI-4594	Micro instruments Samii 23 cm / 9" Tumor knife 5,0mm	
4624	HMI-SI-4595	Micro instruments Samii 23 cm / 9" Tumor knife 6,0mm	
4625	HMI-SI-4595(a)	Micro instruments with protection sleeve 18,5 cm / 7 2/8" Tissue forceps	
4626	HMI-SI-4596	Micro instruments Caspar Micro dissector Straight 20 cm / 7 7/8" 1,0 mm	
4627	HMI-SI-4597	Micro instruments Caspar Micro dissector Straight 23 cm / 9" 4,5 mm	
4628	HMI-SI-4598	Micro instruments Caspar Micro dissector bayonet 23 cm / 9" 4,5 mm	
4629	HMI-SI-4599	Micro instruments Caspar Micro dissector bayonet 23 cm / 9" 2,0mm	
4630	HMI-SI-4600	Micro instruments Caspar Micro dissector bayonet 20 cm / 7 7/8" 1,0mm	
4631	HMI-SI-4601	Micro instruments Caspar Micro dissector bayonet 20 cm / 7 7/8" 1,0mm	
4632	HMI-SI-4602	Micro instruments Caspar Micro dissector bayonet 23 cm / 9" 1,0mm	

4633	HMI-SI-4603	Micro instruments Samii Lancet knife		
4634	HMI-SI-4604	Micro instruments Micro vascular knife 18,5 cm / 7 2/8" bayonet Koos		
4635	HMI-SI-4605	Micro instruments Micro vascular knife 18,5 cm / 7 2/8" bayonet Koos		
4636	HMI-SI-4606	Micro instruments Micro vascular knife 18,5 cm / 7 2/8" bayonet Koos		
4637	HMI-SI-4607	Micro instruments Micro vascular knife 23 cm / 9" Straight		
4638	HMI-SI-4608	Micro instruments Micro vascular knife 18,5 cm / 7 2/8" bayonet Koos		
4639	HMI-SI-4609	Micro instruments Micro vascular knife 18,5 cm / 7 2/8" bayonet Yasargil		
4640	HMI-SI-4610	Micro instruments Micro vascular knife 18,5 cm / 7 2/8" bayonet Yasargil		
4641	HMI-SI-4611	Micro instruments Micro vascular knife 18,5 cm / 7 2/8" bayonet Jacobson		
4642	HMI-SI-4613	Micro instruments Yasargil Suture guide 18,5 cm / 7 2/8" curved 1,5 mm		
4643	HMI-SI-4614	Micro instruments Yasargil Suture guide 18,5 cm / 7 2/8" curved 1,5 mm		
4644	HMI-SI-4615	Micro instruments Yasargil Suture guide 18,5 cm / 7 2/8" curved 1,5 mm		

4645	HMI-SI-4616	Micro instruments Yasargil Suture guide 18,5 cm / 7 2/8" curved 1,5 mm 90°	
4646	HMI-SI-4617	Micro instruments Yasargil Suture guide 18,5 cm / 7 2/8" Straight 1,4 mm	
4647	HMI-SI-4618	Micro instruments Yasargil Suture guide 18,5 cm / 7 2/8" Straight 4,0 mm	
4648	HMI-SI-4619	Micro instruments Yasargil Suture guide 18,5 cm / 7 2/8" Straight 3,0 mm	
4649	HMI-SI-4620	Micro instruments Yasargil Suture guide 18,5 cm / 7 2/8" Straight 3,9 mm	
4650	HMI-SI-4621	Micro instruments Yasargil Suture guide 18,5 cm / 7 2/8" bayonet 3,0 mm	
4651	HMI-SI-4622	Micro instruments Yasargil Suture guide 18,5 cm / 7 2/8" bayonet 3,0 mm	
4652	HMI-SI-4623	Micro instruments Yasargil Suture guide 18,5 cm / 7 2/8" bayonet 3,0 mm	
4653	HMI-SI-4624	Micro instruments Yasargil Suture guide 23 cm / 9" Straight 2,5 mm	
4654	HMI-SI-4625	Micro instruments Yasargil Suture guide 23 cm / 9" Straight 3,0 mm	
4655	HMI-SI-4626	Micro instruments Yasargil Suture guide 23 cm / 9" bayonet 3,0 mm	
4656	HMI-SI-4627	Micro instruments Yasargil Micro dissector Straight 18,5 cm / 7 2/8" 2,6 mm	
4657	HMI-SI-4628	Micro instruments Yasargil Micro dissector Straight 23 cm / 9" 2,2 mm	

4658	HMI-SI-4629	Micro instruments Yasargil Micro dissector Straight 23 cm / 9" 2,2 mm	
4659	HMI-SI-4630	Micro instruments Yasargil Micro dissector bayonet 23 cm / 9" 2,2 mm	
4660	HMI-SI-4631	Micro instruments Yasargil Micro dissector bayonet 23 cm / 9" 2,0 mm	
4661	HMI-SI-4632	Micro instruments, Hooks Jacobson 18,5 cm / 7 2/8" Button probe	
4662	HMI-SI-4633	Micro instruments, Hooks Jacobson 18,5 cm / 7 2/8" Probe, double	
4663	HMI-SI-4634	Micro instruments, Hooks Yasargil 18,5 cm / 7 2/8" Micro curette	
4664	HMI-SI-4635	Micro instruments, Hooks 23 cm / 9" Micro curette	
4665	HMI-SI-4636	Micro instruments, Hooks 23 cm / 9" Micro curette	

4666	HMI-SI-4637	Micro instruments, Hooks 23 cm / 9" Dura Hook sharp 4,0 mm	
4667	HMI-SI-4638	Micro instruments, Hooks 23 cm / 9" Dura Hook blunt 0,8 mm 3,8 mm	
4668	HMI-SI-4639	Micro instruments Micro hooklet 19 cm / 7 4/8" 0,6 mm 90° 3,3 mm	
4669	HMI-SI-4640	Micro instruments Micro hooklet 19 cm / 7 4/8" 1,1 mm 90° 4,5 mm	
4670	HMI-SI-4641	Micro instruments Micro hooklet 19 cm / 7 4/8" 0,6 mm 90° 3,2 mm	
4671	HMI-SI-4642	Micro instruments Micro hooklet 19 cm / 7 4/8" 0,8 mm 90° 3,2 mm	
4672	HMI-SI-4643	Micro instruments Micro hooklet 24,5 cm / 9 6/8" 1,8 mm 90° 5 mm	
4673	HMI-SI-4644	Micro instruments Micro hooklet 24,5 cm / 9 6/8" 2,0 mm 90° 7 mm	

4674	HMI-SI-4645	Micro instruments Micro hooklet 24,5 cm / 9 6/8" 2,5 mm 90° 7 mm	
4675	HMI-SI-4646	Micro instruments Micro hooklet 24,5 cm / 9 6/8" 1,8 mm 45° 11 mm	
4676	HMI-SI-4647	Lamina Spreaders Cloward 16 cm / 6 2/8"	
4677	HMI-SI-4648	Lamina Spreaders Cloward 16 cm / 6 2/8"	
4678	HMI-SI-4649	Lamina Spreaders Inge 16 cm / 6 2/8"	
4679	HMI-SI-4650	Lamina Spreaders Inge 25,5 cm / 10 "	
4680	HMI-SI-4651	Laminectomy Punches Ferris-Smith-Kerrison Punch, with ejector, detachable Jaw width 1 mm 40° cutting upward 18 cm St	
4681	HMI-SI-4652	Laminectomy Punches Ferris-Smith-Kerrison Punch, with ejector, detachable Jaw width 1 mm 40° cutting upward 20 cm St	

4682	HMI-SI-4653	Laminectomy Punches Ferris-Smith-Kerrison Punch, with ejector, detachable Jaw width 1 mm 40° cutting upward 23 cm St
4683	HMI-SI-4654	Laminectomy Punches Ferris-Smith-Kerrison Punch, with ejector, detachable Jaw width 1 mm 40° cutting upward 28 cm St
4684	HMI-SI-4655	Laminectomy Punches Ferris-Smith-Kerrison Punch, with ejector, detachable Jaw width 1 mm 90° cutting upward 18 cm St
4685	HMI-SI-4656	Laminectomy Punches Ferris-Smith-Kerrison Punch, with ejector, detachable Jaw width 1 mm 90° cutting upward 20 cm St
4686	HMI-SI-4657	Laminectomy Punches Ferris-Smith-Kerrison Punch, with ejector, detachable Jaw width 1 mm 90° cutting upward 23 cm St
4687	HMI-SI-4658	Laminectomy Punches Ferris-Smith-Kerrison Punch, with ejector, detachable Jaw width 1 mm 90° cutting upward 28 cm St
4688	HMI-SI-4659	Laminectomy Punches Ferris-Smith-Kerrison Punch, with ejector, detachable Jaw width 1 mm 40° cutting upward 18 cm SB
4689	HMI-SI-4660	Laminectomy Punches Ferris-Smith-Kerrison Punch, with ejector, detachable Jaw width 1 mm 40° cutting upward 20 cm SB
4690	HMI-SI-4661	Laminectomy Punches Ferris-Smith-Kerrison Punch, with ejector, detachable Jaw width 1 mm 40° cutting upward 23 cm SB
4691	HMI-SI-4662	Laminectomy Punches Ferris-Smith-Kerrison Punch, with ejector, detachable Jaw width 1 mm 40° cutting upward 28 cm SB



4692	HMI-SI-4663	Laminectomy Punches Ferris-Smith-Kerrison Punch, with ejector, detachable Jaw width 1 mm 90° cutting upward 18 cm SB
4693	HMI-SI-4664	Laminectomy Punches Ferris-Smith-Kerrison Punch, with ejector, detachable Jaw width 1 mm 90° cutting upward 20 cm SB
4694	HMI-SI-4665	Laminectomy Punches Ferris-Smith-Kerrison Punch, with ejector, detachable Jaw width 1 mm 90° cutting upward 23 cm SB
4695	HMI-SI-4666	Laminectomy Punches Ferris-Smith-Kerrison Punch, with ejector, detachable Jaw width 1 mm 90° cutting upward 28 cm SB
4696	HMI-SI-4667	Laminectomy Punches Ferris-Smith-Kerrison Punch, with ejector, detachable Jaw width 2 mm 40° cutting upward 18 cm St
4697	HMI-SI-4668	Laminectomy Punches Ferris-Smith-Kerrison Punch, with ejector, detachable Jaw width 2 mm 40° cutting upward 20 cm St
4698	HMI-SI-4669	Laminectomy Punches Ferris-Smith-Kerrison Punch, with ejector, detachable Jaw width 2 mm 40° cutting upward 23 cm St
4699	HMI-SI-4670	Laminectomy Punches Ferris-Smith-Kerrison Punch, with ejector, detachable Jaw width 2 mm 40° cutting upward 28 cm St
4700	HMI-SI-4671	Laminectomy Punches Ferris-Smith-Kerrison Punch, with ejector, detachable Jaw width 2 mm 90° cutting upward 18 cm St
4701	HMI-SI-4672	Laminectomy Punches Ferris-Smith-Kerrison Punch, with ejector, detachable Jaw width 2 mm 90° cutting upward 20 cm St

4702	HMI-SI-4673	Laminectomy Punches Ferris-Smith-Kerrison Punch, with ejector, detachable Jaw width 2 mm 90° cutting upward 23 cm St
4703	HMI-SI-4674	Laminectomy Punches Ferris-Smith-Kerrison Punch, with ejector, detachable Jaw width 2 mm 90° cutting upward 28 cm St
4704	HMI-SI-4675	Laminectomy Punches Ferris-Smith-Kerrison Punch, with ejector, detachable Jaw width 2 mm 40° cutting upward 18 cm SB
4705	HMI-SI-4676	Laminectomy Punches Ferris-Smith-Kerrison Punch, with ejector, detachable Jaw width 2 mm 40° cutting upward 20 cm SB
4706	HMI-SI-4677	Laminectomy Punches Ferris-Smith-Kerrison Punch, with ejector, detachable Jaw width 2 mm 40° cutting upward 23 cm SB
4707	HMI-SI-4678	Laminectomy Punches Ferris-Smith-Kerrison Punch, with ejector, detachable Jaw width 2 mm 40° cutting upward 28 cm SB
4708	HMI-SI-4679	Laminectomy Punches Ferris-Smith-Kerrison Punch, with ejector, detachable Jaw width 2 mm 90° cutting upward 18 cm SB
4709	HMI-SI-4680	Laminectomy Punches Ferris-Smith-Kerrison Punch, with ejector, detachable Jaw width 2 mm 90° cutting upward 20 cm SB
4710	HMI-SI-4681	Laminectomy Punches Ferris-Smith-Kerrison Punch, with ejector, detachable Jaw width 2 mm 90° cutting upward 23 cm SB
4711	HMI-SI-4682	Laminectomy Punches Ferris-Smith-Kerrison Punch, with ejector, detachable Jaw width 2 mm 90° cutting upward 28 cm SB

4712	HMI-SI-4683	Laminectomy Punches Ferris-Smith-Kerrison Punch, with ejector, detachable Jaw width 3 mm 40° cutting upward 18 cm St
4713	HMI-SI-4684	Laminectomy Punches Ferris-Smith-Kerrison Punch, with ejector, detachable Jaw width 3 mm 40° cutting upward 20 cm St
4714	HMI-SI-4685	Laminectomy Punches Ferris-Smith-Kerrison Punch, with ejector, detachable Jaw width 3 mm 40° cutting upward 23 cm St
4715	HMI-SI-4686	Laminectomy Punches Ferris-Smith-Kerrison Punch, with ejector, detachable Jaw width 3 mm 40° cutting upward 28 cm St
4716	HMI-SI-4687	Laminectomy Punches Ferris-Smith-Kerrison Punch, with ejector, detachable Jaw width 3 mm 90° cutting upward 18 cm St
4717	HMI-SI-4688	Laminectomy Punches Ferris-Smith-Kerrison Punch, with ejector, detachable Jaw width 3 mm 90° cutting upward 20 cm St
4718	HMI-SI-4689	Laminectomy Punches Ferris-Smith-Kerrison Punch, with ejector, detachable Jaw width 3 mm 90° cutting upward 23 cm St
4719	HMI-SI-4690	Laminectomy Punches Ferris-Smith-Kerrison Punch, with ejector, detachable Jaw width 3 mm 90° cutting upward 28 cm St
4720	HMI-SI-4691	Laminectomy Punches Ferris-Smith-Kerrison Punch, with ejector, detachable Jaw width 3 mm 40° cutting upward 18 cm SB
4721	HMI-SI-4692	Laminectomy Punches Ferris-Smith-Kerrison Punch, with ejector, detachable Jaw width 3 mm 40° cutting upward 20 cm SB

4722	HMI-SI-4693	Laminectomy Punches Ferris-Smith-Kerrison Punch, with ejector, detachable Jaw width 3 mm 40° cutting upward 23 cm SB
4723	HMI-SI-4694	Laminectomy Punches Ferris-Smith-Kerrison Punch, with ejector, detachable Jaw width 3 mm 40° cutting upward 28 cm SB
4724	HMI-SI-4695	Laminectomy Punches Ferris-Smith-Kerrison Punch, with ejector, detachable Jaw width 3 mm 90° cutting upward 18 cm SB
4725	HMI-SI-4696	Laminectomy Punches Ferris-Smith-Kerrison Punch, with ejector, detachable Jaw width 3 mm 90° cutting upward 20 cm SB
4726	HMI-SI-4697	Laminectomy Punches Ferris-Smith-Kerrison Punch, with ejector, detachable Jaw width 3 mm 90° cutting upward 23 cm SB
4727	HMI-SI-4698	Laminectomy Punches Ferris-Smith-Kerrison Punch, with ejector, detachable Jaw width 3 mm 90° cutting upward 28 cm SB
4728	HMI-SI-4699	Laminectomy Punches Ferris-Smith-Kerrison Punch, with ejector, detachable Jaw width 4 mm 40° cutting upward 18 cm St
4729	HMI-SI-4700	Laminectomy Punches Ferris-Smith-Kerrison Punch, with ejector, detachable Jaw width 4 mm 40° cutting upward 20 cm St
4730	HMI-SI-4701	Laminectomy Punches Ferris-Smith-Kerrison Punch, with ejector, detachable Jaw width 4 mm 40° cutting upward 23 cm St
4731	HMI-SI-4702	Laminectomy Punches Ferris-Smith-Kerrison Punch, with ejector, detachable Jaw width 4 mm 40° cutting upward 28 cm St

4732	HMI-SI-4703	Laminectomy Punches Ferris-Smith-Kerrison Punch, with ejector, detachable Jaw width 4 mm 90° cutting upward 18 cm St
4733	HMI-SI-4704	Laminectomy Punches Ferris-Smith-Kerrison Punch, with ejector, detachable Jaw width 4 mm 90° cutting upward 20 cm St
4734	HMI-SI-4705	Laminectomy Punches Ferris-Smith-Kerrison Punch, with ejector, detachable Jaw width 4 mm 90° cutting upward 23 cm St
4735	HMI-SI-4706	Laminectomy Punches Ferris-Smith-Kerrison Punch, with ejector, detachable Jaw width 4 mm 90° cutting upward 28 cm St
4736	HMI-SI-4707	Laminectomy Punches Ferris-Smith-Kerrison Punch, with ejector, detachable Jaw width 4 mm 40° cutting upward 18 cm SB
4737	HMI-SI-4708	Laminectomy Punches Ferris-Smith-Kerrison Punch, with ejector, detachable Jaw width 4 mm 40° cutting upward 20 cm SB
4738	HMI-SI-4709	Laminectomy Punches Ferris-Smith-Kerrison Punch, with ejector, detachable Jaw width 4 mm 40° cutting upward 23 cm SB
4739	HMI-SI-4710	Laminectomy Punches Ferris-Smith-Kerrison Punch, with ejector, detachable Jaw width 4 mm 40° cutting upward 28 cm SB
4740	HMI-SI-4711	Laminectomy Punches Ferris-Smith-Kerrison Punch, with ejector, detachable Jaw width 4 mm 90° cutting upward 18 cm SB
4741	HMI-SI-4712	Laminectomy Punches Ferris-Smith-Kerrison Punch, with ejector, detachable Jaw width 4 mm 90° cutting upward 20 cm SB

4742	HMI-SI-4713	Laminectomy Punches Ferris-Smith-Kerrison Punch, with ejector, detachable Jaw width 4 mm 90° cutting upward 23 cm SB
4743	HMI-SI-4714	Laminectomy Punches Ferris-Smith-Kerrison Punch, with ejector, detachable Jaw width 4 mm 90° cutting upward 28 cm SB
4744	HMI-SI-4715	Laminectomy Punches Ferris-Smith-Kerrison Punch, with ejector, detachable Jaw width 5 mm 40° cutting upward 18 cm St
4745	HMI-SI-4716	Laminectomy Punches Ferris-Smith-Kerrison Punch, with ejector, detachable Jaw width 5 mm 40° cutting upward 20 cm St
4746	HMI-SI-4717	Laminectomy Punches Ferris-Smith-Kerrison Punch, with ejector, detachable Jaw width 5 mm 40° cutting upward 23 cm St
4747	HMI-SI-4718	Laminectomy Punches Ferris-Smith-Kerrison Punch, with ejector, detachable Jaw width 5 mm 40° cutting upward 28 cm St
4748	HMI-SI-4719	Laminectomy Punches Ferris-Smith-Kerrison Punch, with ejector, detachable Jaw width 5 mm 90° cutting upward 18 cm St
4749	HMI-SI-4719(a)	Laminectomy Punches Ferris-Smith-Kerrison Punch, with ejector, detachable Jaw width 5 mm 90° cutting upward 20 cm St
4750	HMI-SI-4720	Laminectomy Punches Ferris-Smith-Kerrison Punch, with ejector, detachable Jaw width 5 mm 90° cutting upward 23 cm St
4751	HMI-SI-4721	Laminectomy Punches Ferris-Smith-Kerrison Punch, with ejector, detachable Jaw width 5 mm 90° cutting upward 28 cm St

4752	HMI-SI-4722	Laminectomy Punches Ferris-Smith-Kerrison Punch, with ejector, detachable Jaw width 5 mm 40° cutting upward 18 cm SB
4753	HMI-SI-4723	Laminectomy Punches Ferris-Smith-Kerrison Punch, with ejector, detachable Jaw width 5 mm 40° cutting upward 20 cm SB
4754	HMI-SI-4724	Laminectomy Punches Ferris-Smith-Kerrison Punch, with ejector, detachable Jaw width 5 mm 40° cutting upward 23 cm SB
4755	HMI-SI-4725	Laminectomy Punches Ferris-Smith-Kerrison Punch, with ejector, detachable Jaw width 5 mm 40° cutting upward 28 cm SB
4756	HMI-SI-4726	Laminectomy Punches Ferris-Smith-Kerrison Punch, with ejector, detachable Jaw width 5 mm 90° cutting upward 18 cm SB
4757	HMI-SI-4727	Laminectomy Punches Ferris-Smith-Kerrison Punch, with ejector, detachable Jaw width 5 mm 90° cutting upward 20 cm SB
4758	HMI-SI-4728	Laminectomy Punches Ferris-Smith-Kerrison Punch, with ejector, detachable Jaw width 5 mm 90° cutting upward 23 cm SB
4759	HMI-SI-4729	Laminectomy Punches Ferris-Smith-Kerrison Punch, with ejector, detachable Jaw width 5 mm 90° cutting upward 28 cm SB
4760	HMI-SI-4730	Laminectomy Punches Ferris-Smith-Kerrison Punch, with ejector, detachable Jaw width 6 mm 40° cutting upward 18 cm St
4761	HMI-SI-4731	Laminectomy Punches Ferris-Smith-Kerrison Punch, with ejector, detachable Jaw width 6 mm 40° cutting upward 20 cm St

4762	HMI-SI-4732	Laminectomy Punches Ferris-Smith-Kerrison Punch, with ejector, detachable Jaw width 6 mm 40° cutting upward 23 cm St
4763	HMI-SI-4733	Laminectomy Punches Ferris-Smith-Kerrison Punch, with ejector, detachable Jaw width 6 mm 40° cutting upward 28 cm St
4764	HMI-SI-4734	Laminectomy Punches Ferris-Smith-Kerrison Punch, with ejector, detachable Jaw width 6 mm 90° cutting upward 18 cm St
4765	HMI-SI-4735	Laminectomy Punches Ferris-Smith-Kerrison Punch, with ejector, detachable Jaw width 6 mm 90° cutting upward 20 cm St
4766	HMI-SI-4736	Laminectomy Punches Ferris-Smith-Kerrison Punch, with ejector, detachable Jaw width 6 mm 90° cutting upward 23 cm St
4767	HMI-SI-4737	Laminectomy Punches Ferris-Smith-Kerrison Punch, with ejector, detachable Jaw width 6 mm 90° cutting upward 28 cm St
4768	HMI-SI-4738	Laminectomy Punches Ferris-Smith-Kerrison Punch, with ejector, detachable Jaw width 5 mm 40° cutting upward 18 cm SB
4769	HMI-SI-4739	Laminectomy Punches Ferris-Smith-Kerrison Punch, with ejector, detachable Jaw width 6 mm 40° cutting upward 20 cm SB
4770	HMI-SI-4740	Laminectomy Punches Ferris-Smith-Kerrison Punch, with ejector, detachable Jaw width 6 mm 40° cutting upward 23 cm SB
4771	HMI-SI-4741	Laminectomy Punches Ferris-Smith-Kerrison Punch, with ejector, detachable Jaw width 6 mm 40° cutting upward 28 cm SB

4772	HMI-SI-4742	Laminectomy Punches Ferris-Smith-Kerrison Punch, with ejector, detachable Jaw width 6 mm 90° cutting upward 18 cm SB
4773	HMI-SI-4743	Laminectomy Punches Ferris-Smith-Kerrison Punch, with ejector, detachable Jaw width 6 mm 90° cutting upward 20 cm SB
4774	HMI-SI-4744	Laminectomy Punches Ferris-Smith-Kerrison Punch, with ejector, detachable Jaw width 6 mm 90° cutting upward 23 cm SB
4775	HMI-SI-4745	Laminectomy Punches Ferris-Smith-Kerrison Punch, with ejector, detachable Jaw width 6 mm 90° cutting upward 28 cm SB
4776	HMI-SI-4746	Laminectomy Punches Ferris-Smith-Kerrison Punch, with ejector, detachable, thin plate Jaw width 1 mm 40° cutting upward 18 cm St
4777	HMI-SI-4747	Laminectomy Punches Ferris-Smith-Kerrison Punch, with ejector, detachable, thin plate Jaw width 1 mm 40° cutting upward 20 cm St
4778	HMI-SI-4748	Laminectomy Punches Ferris-Smith-Kerrison Punch, with ejector, detachable, thin plate Jaw width 1 mm 40° cutting upward 23 cm St
4779	HMI-SI-4749	Laminectomy Punches Ferris-Smith-Kerrison Punch, with ejector, detachable, thin plate Jaw width 1 mm 40° cutting upward 28 cm St
4780	HMI-SI-4750	Laminectomy Punches Ferris-Smith-Kerrison Punch, with ejector, detachable, thin plate Jaw width 1 mm 90° cutting upward 18 cm St
4781	HMI-SI-4751	Laminectomy Punches Ferris-Smith-Kerrison Punch, with ejector, detachable, thin plate Jaw width 1 mm 90° cutting upward 20 cm St



4782	HMI-SI-4752	Laminectomy Punches Ferris-Smith-Kerrison Punch, with ejector, detachable, thin plate Jaw width 1 mm 90° cutting upward 23 cm St
4783	HMI-SI-4753	Laminectomy Punches Ferris-Smith-Kerrison Punch, with ejector, detachable, thin plate Jaw width 1 mm 90° cutting upward 28 cm St
4784	HMI-SI-4754	Laminectomy Punches Ferris-Smith-Kerrison Punch, with ejector, detachable, thin plate Jaw width 1 mm 40° cutting upward 18 cm SB
4785	HMI-SI-4755	Laminectomy Punches Ferris-Smith-Kerrison Punch, with ejector, detachable, thin plate Jaw width 1 mm 40° cutting upward 20 cm SB
4786	HMI-SI-4756	Laminectomy Punches Ferris-Smith-Kerrison Punch, with ejector, detachable, thin plate Jaw width 1 mm 40° cutting upward 23 cm SB
4787	HMI-SI-4757	Laminectomy Punches Ferris-Smith-Kerrison Punch, with ejector, detachable, thin plate Jaw width 1 mm 40° cutting upward 28 cm SB
4788	HMI-SI-4758	Laminectomy Punches Ferris-Smith-Kerrison Punch, with ejector, detachable, thin plate Jaw width 1 mm 90° cutting upward 18 cm SB
4789	HMI-SI-4760	Laminectomy Punches Ferris-Smith-Kerrison Punch, with ejector, detachable, thin plate Jaw width 1 mm 90° cutting upward 20 cm SB
4790	HMI-SI-4761	Laminectomy Punches Ferris-Smith-Kerrison Punch, with ejector, detachable, thin plate Jaw width 1 mm 90° cutting upward 23 cm SB
4791	HMI-SI-4762	Laminectomy Punches Ferris-Smith-Kerrison Punch, with ejector, detachable, thin plate Jaw width 1 mm 90° cutting upward 28 cm SB



4792	HMI-SI-4763	Laminectomy Punches Ferris-Smith-Kerrison Punch, with ejector, detachable, thin plate Jaw width 2 mm 40° cutting upward 18 cm St
4793	HMI-SI-4764	Laminectomy Punches Ferris-Smith-Kerrison Punch, with ejector, detachable, thin plate Jaw width 2 mm 40° cutting upward 20 cm St
4794	HMI-SI-4765	Laminectomy Punches Ferris-Smith-Kerrison Punch, with ejector, detachable, thin plate Jaw width 2 mm 40° cutting upward 23 cm St
4795	HMI-SI-4766	Laminectomy Punches Ferris-Smith-Kerrison Punch, with ejector, detachable, thin plate Jaw width 2 mm 40° cutting upward 28 cm St
4796	HMI-SI-4767	Laminectomy Punches Ferris-Smith-Kerrison Punch, with ejector, detachable, thin plate Jaw width 2 mm 90° cutting upward 18 cm St
4797	HMI-SI-4768	Laminectomy Punches Ferris-Smith-Kerrison Punch, with ejector, detachable, thin plate Jaw width 2 mm 90° cutting upward 20 cm St
4798	HMI-SI-4769	Laminectomy Punches Ferris-Smith-Kerrison Punch, with ejector, detachable, thin plate Jaw width 2 mm 90° cutting upward 23 cm St
4799	HMI-SI-4770	Laminectomy Punches Ferris-Smith-Kerrison Punch, with ejector, detachable, thin plate Jaw width 2 mm 90° cutting upward 28 cm St
4800	HMI-SI-4771	Laminectomy Punches Ferris-Smith-Kerrison Punch, with ejector, detachable, thin plate Jaw width 2 mm 40° cutting upward 18 cm SB
4801	HMI-SI-4772	Laminectomy Punches Ferris-Smith-Kerrison Punch, with ejector, detachable, thin plate Jaw width 2 mm 40° cutting upward 20 cm SB

4802	HMI-SI-4773	Laminectomy Punches Ferris-Smith-Kerrison Punch, with ejector, detachable, thin plate Jaw width 2 mm 40° cutting upward 23 cm SB
4803	HMI-SI-4774	Laminectomy Punches Ferris-Smith-Kerrison Punch, with ejector, detachable, thin plate Jaw width 2 mm 40° cutting upward 28 cm SB
4804	HMI-SI-4775	Laminectomy Punches Ferris-Smith-Kerrison Punch, with ejector, detachable, thin plate Jaw width 2 mm 90° cutting upward 18 cm SB
4805	HMI-SI-4776	Laminectomy Punches Ferris-Smith-Kerrison Punch, with ejector, detachable, thin plate Jaw width 2 mm 90° cutting upward 20 cm SB
4806	HMI-SI-4777	Laminectomy Punches Ferris-Smith-Kerrison Punch, with ejector, detachable, thin plate Jaw width 2 mm 90° cutting upward 23 cm SB
4807	HMI-SI-4778	Laminectomy Punches Ferris-Smith-Kerrison Punch, with ejector, detachable, thin plate Jaw width 2 mm 90° cutting upward 28 cm SB
4808	HMI-SI-4779	Laminectomy Punches Ferris-Smith-Kerrison Punch, with ejector, detachable, thin plate Jaw width 3 mm 40° cutting upward 18 cm St
4809	HMI-SI-4780	Laminectomy Punches Ferris-Smith-Kerrison Punch, with ejector, detachable, thin plate Jaw width 3 mm 40° cutting upward 20 cm St
4810	HMI-SI-4781	Laminectomy Punches Ferris-Smith-Kerrison Punch, with ejector, detachable, thin plate Jaw width 3 mm 40° cutting upward 23 cm St
4811	HMI-SI-4782	Laminectomy Punches Ferris-Smith-Kerrison Punch, with ejector, detachable, thin plate Jaw width 3 mm 40° cutting upward 28 cm St

4812	HMI-SI-4783	Laminectomy Punches Ferris-Smith-Kerrison Punch, with ejector, detachable, thin plate Jaw width 3 mm 90° cutting upward 18 cm St
4813	HMI-SI-4784	Laminectomy Punches Ferris-Smith-Kerrison Punch, with ejector, detachable, thin plate Jaw width 3 mm 90° cutting upward 20 cm St
4814	HMI-SI-4785	Laminectomy Punches Ferris-Smith-Kerrison Punch, with ejector, detachable, thin plate Jaw width 3 mm 90° cutting upward 23 cm St
4815	HMI-SI-4786	Laminectomy Punches Ferris-Smith-Kerrison Punch, with ejector, detachable, thin plate Jaw width 3 mm 90° cutting upward 28 cm St
4816	HMI-SI-4787	Laminectomy Punches Ferris-Smith-Kerrison Punch, with ejector, detachable, thin plate Jaw width 3 mm 40° cutting upward 18 cm SB
4817	HMI-SI-4788	Laminectomy Punches Ferris-Smith-Kerrison Punch, with ejector, detachable, thin plate Jaw width 3 mm 40° cutting upward 20 cm SB
4818	HMI-SI-4789	Laminectomy Punches Ferris-Smith-Kerrison Punch, with ejector, detachable, thin plate Jaw width 3 mm 40° cutting upward 23 cm SB
4819	HMI-SI-4790	Laminectomy Punches Ferris-Smith-Kerrison Punch, with ejector, detachable, thin plate Jaw width 3 mm 40° cutting upward 28 cm SB
4820	HMI-SI-4791	Laminectomy Punches Ferris-Smith-Kerrison Punch, with ejector, detachable, thin plate Jaw width 3 mm 90° cutting upward 18 cm SB
4821	HMI-SI-4792	Laminectomy Punches Ferris-Smith-Kerrison Punch, with ejector, detachable, thin plate Jaw width 3 mm 90° cutting upward 20 cm SB

4822	HMI-SI-4793	Laminectomy Punches Ferris-Smith-Kerrison Punch, with ejector, detachable, thin plate Jaw width 3 mm 90° cutting upward 23 cm SB
4823	HMI-SI-4794	Laminectomy Punches Ferris-Smith-Kerrison Punch, with ejector, detachable, thin plate Jaw width 3 mm 90° cutting upward 28 cm SB
4824	HMI-SI-4795	Laminectomy Punches Ferris-Smith-Kerrison Punch, with ejector, detachable, thin plate Jaw width 4 mm 40° cutting upward 18 cm St
4825	HMI-SI-4796	Laminectomy Punches Ferris-Smith-Kerrison Punch, with ejector, detachable, thin plate Jaw width 4 mm 40° cutting upward 20 cm St
4826	HMI-SI-4797	Laminectomy Punches Ferris-Smith-Kerrison Punch, with ejector, detachable, thin plate Jaw width 4 mm 40° cutting upward 23 cm St
4827	HMI-SI-4798	Laminectomy Punches Ferris-Smith-Kerrison Punch, with ejector, detachable, thin plate Jaw width 4 mm 40° cutting upward 28 cm St
4828	HMI-SI-4799	Laminectomy Punches Ferris-Smith-Kerrison Punch, with ejector, detachable, thin plate Jaw width 4 mm 90° cutting upward 18 cm St
4829	HMI-SI-4800	Laminectomy Punches Ferris-Smith-Kerrison Punch, with ejector, detachable, thin plate Jaw width 4 mm 90° cutting upward 20 cm St
4830	HMI-SI-4801	Laminectomy Punches Ferris-Smith-Kerrison Punch, with ejector, detachable, thin plate Jaw width 4 mm 90° cutting upward 23 cm St
4831	HMI-SI-4802	Laminectomy Punches Ferris-Smith-Kerrison Punch, with ejector, detachable, thin plate Jaw width 4 mm 90° cutting upward 28 cm St

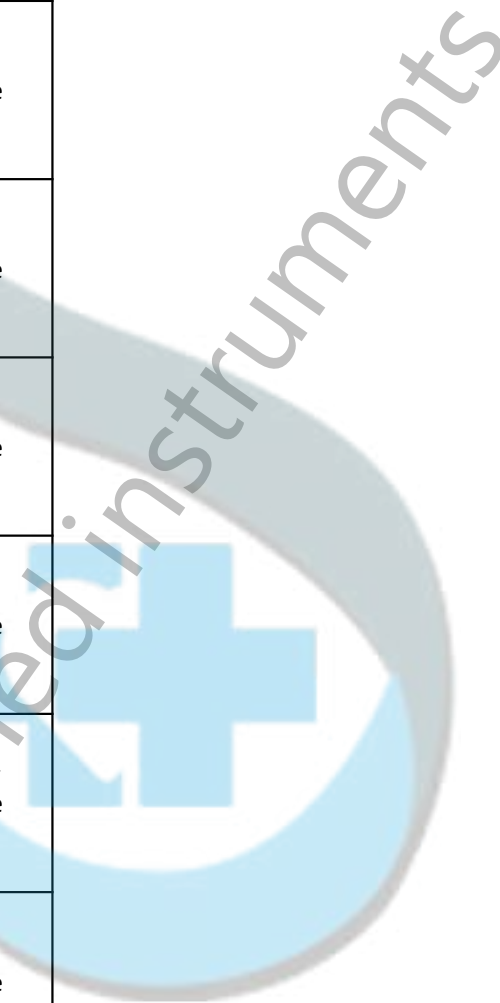

4832	HMI-SI-4803	Laminectomy Punches Ferris-Smith-Kerrison Punch, with ejector, detachable, thin plate Jaw width 4 mm 40° cutting upward 18 cm SB
4833	HMI-SI-4804	Laminectomy Punches Ferris-Smith-Kerrison Punch, with ejector, detachable, thin plate Jaw width 4 mm 40° cutting upward 20 cm SB
4834	HMI-SI-4805	Laminectomy Punches Ferris-Smith-Kerrison Punch, with ejector, detachable, thin plate Jaw width 4 mm 40° cutting upward 23 cm SB
4835	HMI-SI-4806	Laminectomy Punches Ferris-Smith-Kerrison Punch, with ejector, detachable, thin plate Jaw width 4 mm 40° cutting upward 28 cm SB
4836	HMI-SI-4807	Laminectomy Punches Ferris-Smith-Kerrison Punch, with ejector, detachable, thin plate Jaw width 4 mm 90° cutting upward 18 cm SB
4837	HMI-SI-4808	Laminectomy Punches Ferris-Smith-Kerrison Punch, with ejector, detachable, thin plate Jaw width 4 mm 90° cutting upward 20 cm SB
4838	HMI-SI-4809	Laminectomy Punches Ferris-Smith-Kerrison Punch, with ejector, detachable, thin plate Jaw width 4 mm 90° cutting upward 23 cm SB
4839	HMI-SI-4810	Laminectomy Punches Ferris-Smith-Kerrison Punch, with ejector, detachable, thin plate Jaw width 4 mm 90° cutting upward 28 cm SB
4840	HMI-SI-4811	Laminectomy Punches Ferris-Smith-Kerrison Punch, with ejector, detachable, thin plate Jaw width 5 mm 40° cutting upward 18 cm St
4841	HMI-SI-4812	Laminectomy Punches Ferris-Smith-Kerrison Punch, with ejector, detachable, thin plate Jaw width 5 mm 40° cutting upward 20 cm St



4842	HMI-SI-4813	Laminectomy Punches Ferris-Smith-Kerrison Punch, with ejector, detachable, thin plate Jaw width 5 mm 40° cutting upward 23 cm St
4843	HMI-SI-4814	Laminectomy Punches Ferris-Smith-Kerrison Punch, with ejector, detachable Jaw, thin plate width 5 mm 40° cutting upward 28 cm St
4844	HMI-SI-4815	Laminectomy Punches Ferris-Smith-Kerrison Punch, with ejector, detachable Jaw, thin plate width 5 mm 90° cutting upward 18 cm St
4845	HMI-SI-4816	Laminectomy Punches Ferris-Smith-Kerrison Punch, with ejector, detachable, thin plate Jaw width 5 mm 90° cutting upward 20 cm St
4846	HMI-SI-4817	Laminectomy Punches Ferris-Smith-Kerrison Punch, with ejector, detachable, thin plate Jaw width 5 mm 90° cutting upward 23 cm St
4847	HMI-SI-4818	Laminectomy Punches Ferris-Smith-Kerrison Punch, with ejector, detachable, thin plate Jaw width 5 mm 90° cutting upward 28 cm St
4848	HMI-SI-4819	Laminectomy Punches Ferris-Smith-Kerrison Punch, with ejector, detachable, thin plate Jaw width 5 mm 40° cutting upward 18 cm SB
4849	HMI-SI-4820	Laminectomy Punches Ferris-Smith-Kerrison Punch, with ejector, detachable, thin plate Jaw width 5 mm 40° cutting upward 20 cm SB
4850	HMI-SI-4821	Laminectomy Punches Ferris-Smith-Kerrison Punch, with ejector, detachable, thin plate Jaw width 5 mm 40° cutting upward 23 cm SB
4851	HMI-SI-4822	Laminectomy Punches Ferris-Smith-Kerrison Punch, with ejector, detachable, thin plate Jaw width 5 mm 40° cutting upward 28 cm SB

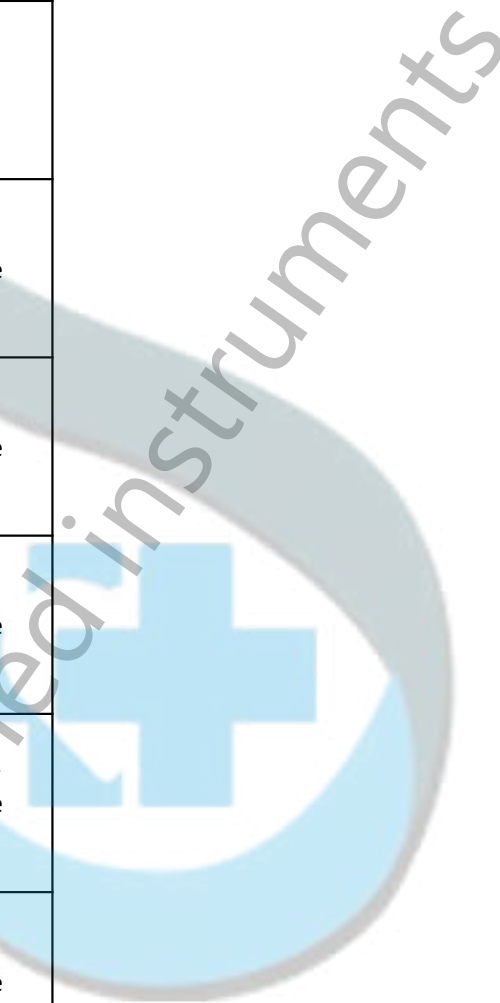

4852	HMI-SI-4823	Laminectomy Punches Ferris-Smith-Kerrison Punch, with ejector, detachable, thin plate Jaw width 5 mm 90° cutting upward 18 cm SB
4853	HMI-SI-4824	Laminectomy Punches Ferris-Smith-Kerrison Punch, with ejector, detachable, thin plate Jaw width 5 mm 90° cutting upward 20 cm SB
4854	HMI-SI-4825	Laminectomy Punches Ferris-Smith-Kerrison Punch, with ejector, detachable, thin plate Jaw width 5 mm 90° cutting upward 23 cm SB
4855	HMI-SI-4826	Laminectomy Punches Ferris-Smith-Kerrison Punch, with ejector, detachable, thin plate Jaw width 5 mm 90° cutting upward 28 cm SB
4856	HMI-SI-4827	Laminectomy Punches Ferris-Smith-Kerrison Punch, with ejector, detachable, thin plate Jaw width 6 mm 40° cutting upward 18 cm St
4857	HMI-SI-4828	Laminectomy Punches Ferris-Smith-Kerrison Punch, with ejector, detachable, thin plate Jaw width 6 mm 40° cutting upward 20 cm St
4858	HMI-SI-4829	Laminectomy Punches Ferris-Smith-Kerrison Punch, with ejector, detachable, thin plate Jaw width 6 mm 40° cutting upward 23 cm St
4859	HMI-SI-4830	Laminectomy Punches Ferris-Smith-Kerrison Punch, with ejector, detachable, thin plate Jaw width 6 mm 40° cutting upward 28 cm St
4860	HMI-SI-4831	Laminectomy Punches Ferris-Smith-Kerrison Punch, with ejector, detachable, thin plate Jaw width 6 mm 90° cutting upward 18 cm St
4861	HMI-SI-4832	Laminectomy Punches Ferris-Smith-Kerrison Punch, with ejector, detachable, thin plate Jaw width 6 mm 90° cutting upward 20 cm St

4862	HMI-SI-4833	Laminectomy Punches Ferris-Smith-Kerrison Punch, with ejector, detachable, thin plate Jaw width 6 mm 90° cutting upward 23 cm St
4863	HMI-SI-4834	Laminectomy Punches Ferris-Smith-Kerrison Punch, with ejector, detachable, thin plate Jaw width 6 mm 90° cutting upward 28 cm St
4864	HMI-SI-4835	Laminectomy Punches Ferris-Smith-Kerrison Punch, with ejector, detachable, thin plate Jaw width 5 mm 40° cutting upward 18 cm SB
4865	HMI-SI-4836	Laminectomy Punches Ferris-Smith-Kerrison Punch, with ejector, detachable, thin plate Jaw width 6 mm 40° cutting upward 20 cm SB
4866	HMI-SI-4837	Laminectomy Punches Ferris-Smith-Kerrison Punch, with ejector, detachable, thin plate Jaw width 6 mm 40° cutting upward 23 cm SB
4867	HMI-SI-4838	Laminectomy Punches Ferris-Smith-Kerrison Punch, with ejector, detachable, thin plate Jaw width 6 mm 40° cutting upward 28 cm SB
4868	HMI-SI-4839	Laminectomy Punches Ferris-Smith-Kerrison Punch, with ejector, detachable, thin plate Jaw width 6 mm 90° cutting upward 18 cm SB
4869	HMI-SI-4840	Laminectomy Punches Ferris-Smith-Kerrison Punch, with ejector, detachable, thin plate Jaw width 6 mm 90° cutting upward 20 cm SB
4870	HMI-SI-4841	Laminectomy Punches Ferris-Smith-Kerrison Punch, with ejector, detachable, thin plate Jaw width 6 mm 90° cutting upward 23 cm SB
4871	HMI-SI-4842	Laminectomy Punches Ferris-Smith-Kerrison Punch, with ejector, detachable, thin plate Jaw width 6 mm 90° cutting upward 28 cm SB

4872	HMI-SI-4843	Laminectomy Punches Ferris-Smith-Kerrison Punch, with ejector, detachable, long stroke Jaw width 1 mm 40° cutting upward 18 cm St
4873	HMI-SI-4844	Laminectomy Punches Ferris-Smith-Kerrison Punch, with ejector, detachable, long stroke Jaw width 1 mm 40° cutting upward 18 cm SB
4874	HMI-SI-4845	Laminectomy Punches Ferris-Smith-Kerrison Punch, with ejector, detachable, long stroke Jaw width 2 mm 40° cutting upward 18 cm St
4875	HMI-SI-4846	Laminectomy Punches Ferris-Smith-Kerrison Punch, with ejector, detachable, long stroke Jaw width 2 mm 40° cutting upward 18 cm SB
4876	HMI-SI-4847	Laminectomy Punches Ferris-Smith-Kerrison Punch, with ejector, detachable, long stroke Jaw width 3 mm 40° cutting upward 18 cm St
4877	HMI-SI-4848	Laminectomy Punches Ferris-Smith-Kerrison Punch, with ejector, detachable, long stroke Jaw width 3 mm 40° cutting upward 18 cm SB
4878	HMI-SI-4849	Laminectomy Punches Ferris-Smith-Kerrison Punch, with ejector, detachable, long stroke Jaw width 4 mm 40° cutting upward 18 cm St
4879	HMI-SI-4850	Laminectomy Punches Ferris-Smith-Kerrison Punch, with ejector, detachable, long stroke Jaw width 4 mm 40° cutting upward 18 cm SB
4880	HMI-SI-4851	Laminectomy Punches Ferris-Smith-Kerrison Punch, with ejector, detachable, long stroke Jaw width 5 mm 40° cutting upward 18 cm St
4881	HMI-SI-4852	Laminectomy Punches Ferris-Smith-Kerrison Punch, with ejector, detachable, long stroke Jaw width 5 mm 40° cutting upward 18 cm SB



4882	HMI-SI-4853	Laminectomy Punches Ferris-Smith-Kerrison Punch, with ejector, detachable, long stroke Jaw width 6 mm 40° cutting upward 18 cm St
4883	HMI-SI-4854	Laminectomy Punches Ferris-Smith-Kerrison Punch, with ejector, detachable, long stroke Jaw width 6 mm 40° cutting upward 18 cm SB
4884	HMI-SI-4855	Laminectomy Punches Ferris-Smith-Kerrison Punch, with ejector, detachable, thin plate, long stroke Jaw width 1 mm 40° cutting upward 18 cm St
4885	HMI-SI-4856	Laminectomy Punches Ferris-Smith-Kerrison Punch, with ejector, detachable, thin plate, long stroke Jaw width 1 mm 40° cutting upward 18 cm SB
4886	HMI-SI-4857	Laminectomy Punches Ferris-Smith-Kerrison Punch, with ejector, detachable, thin plate, long stroke Jaw width 2 mm 40° cutting upward 18 cm St
4887	HMI-SI-4858	Laminectomy Punches Ferris-Smith-Kerrison Punch, with ejector, detachable, thin plate, long stroke Jaw width 2 mm 40° cutting upward 18 cm SB
4888	HMI-SI-4859	Laminectomy Punches Ferris-Smith-Kerrison Punch, with ejector, detachable, thin plate, long stroke Jaw width 3 mm 40° cutting upward 18 cm St
4889	HMI-SI-4860	Laminectomy Punches Ferris-Smith-Kerrison Punch, with ejector, detachable, thin plate, long stroke Jaw width 3 mm 40° cutting upward 18 cm SB

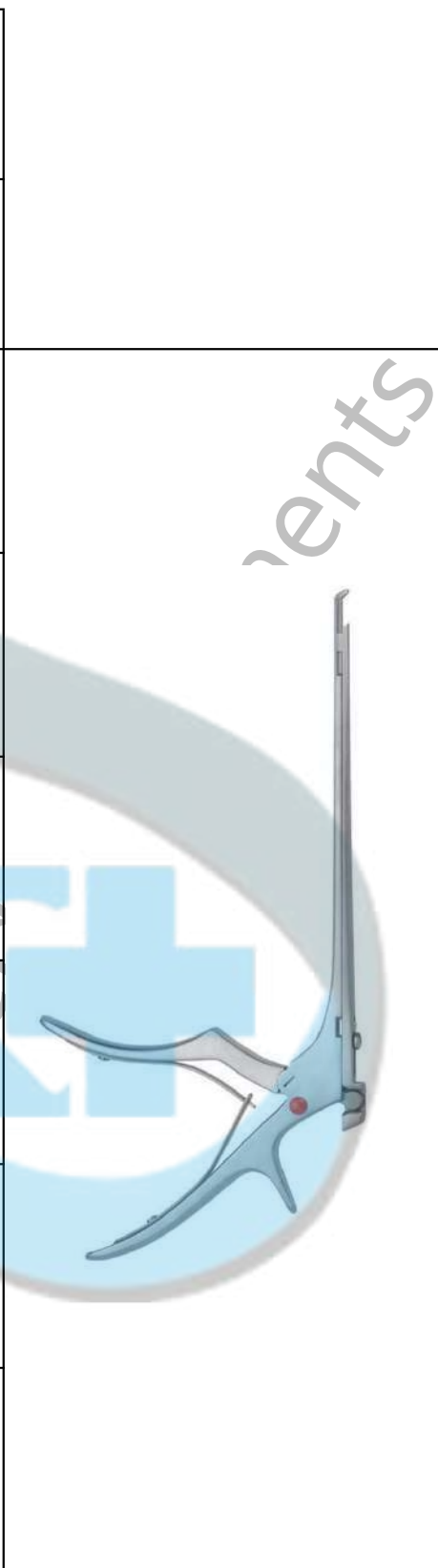

4890	HMI-SI-4861	Laminectomy Punches Ferris-Smith-Kerrison Punch, with ejector, detachable, thin plate, long stroke Jaw width 4 mm 40° cutting upward 18 cm St
4891	HMI-SI-4862	Laminectomy Punches Ferris-Smith-Kerrison Punch, with ejector, detachable, thin plate, long stroke Jaw width 4 mm 40° cutting upward 18 cm SB
4892	HMI-SI-4863	Laminectomy Punches Ferris-Smith-Kerrison Punch, with ejector, detachable, thin plate, long stroke Jaw width 5 mm 40° cutting upward 18 cm St
4893	HMI-SI-4864	Laminectomy Punches Ferris-Smith-Kerrison Punch, with ejector, detachable, thin plate, long stroke Jaw width 5 mm 40° cutting upward 18 cm SB
4894	HMI-SI-4865	Laminectomy Punches Ferris-Smith-Kerrison Punch, with ejector, detachable, thin plate, long stroke Jaw width 6 mm 40° cutting upward 18 cm St
4895	HMI-SI-4866	Laminectomy Punches Ferris-Smith-Kerrison Punch, with ejector, detachable, thin plate, long stroke Jaw width 6 mm 40° cutting upward 18 cm SB
4896	HMI-SI-4867	Laminectomy Punches Ferris-Smith-Kerrison Punch, with ejector, detachable Jaw width 1 mm 40° cutting upward 18 cm St
4897	HMI-SI-4868	Laminectomy Punches Ferris-Smith-Kerrison Punch, with ejector, detachable Jaw width 1 mm 40° cutting upward 20 cm St



4898	HMI-SI-4869	Laminectomy Punches Ferris-Smith-Kerrison Punch, with ejector, detachable Jaw width 1 mm 40° cutting upward 23 cm St
4899	HMI-SI-4870	Laminectomy Punches Ferris-Smith-Kerrison Punch, with ejector, detachable Jaw width 1 mm 90° cutting upward 18 cm St
4900	HMI-SI-4871	Laminectomy Punches Ferris-Smith-Kerrison Punch, with ejector, detachable Jaw width 1 mm 90° cutting upward 20 cm St
4901	HMI-SI-4872	Laminectomy Punches Ferris-Smith-Kerrison Punch, with ejector, detachable Jaw width 1 mm 90° cutting upward 23 cm St
4902	HMI-SI-4873	Laminectomy Punches Ferris-Smith-Kerrison Punch, with ejector, detachable Jaw width 1 mm 40° cutting upward 18 cm SB
4903	HMI-SI-4874	Laminectomy Punches Ferris-Smith-Kerrison Punch, with ejector, detachable Jaw width 1 mm 40° cutting upward 20 cm SB
4904	HMI-SI-4875	Laminectomy Punches Ferris-Smith-Kerrison Punch, with ejector, detachable Jaw width 1 mm 40° cutting upward 23 cm SB
4905	HMI-SI-4876	Laminectomy Punches Ferris-Smith-Kerrison Punch, with ejector, detachable Jaw width 1 mm 90° cutting upward 18 cm SB
4906	HMI-SI-4877	Laminectomy Punches Ferris-Smith-Kerrison Punch, with ejector, detachable Jaw width 1 mm 90° cutting upward 20 cm SB
4907	HMI-SI-4878	Laminectomy Punches Ferris-Smith-Kerrison Punch, with ejector, detachable Jaw width 1 mm 90° cutting upward 23 cm SB



3

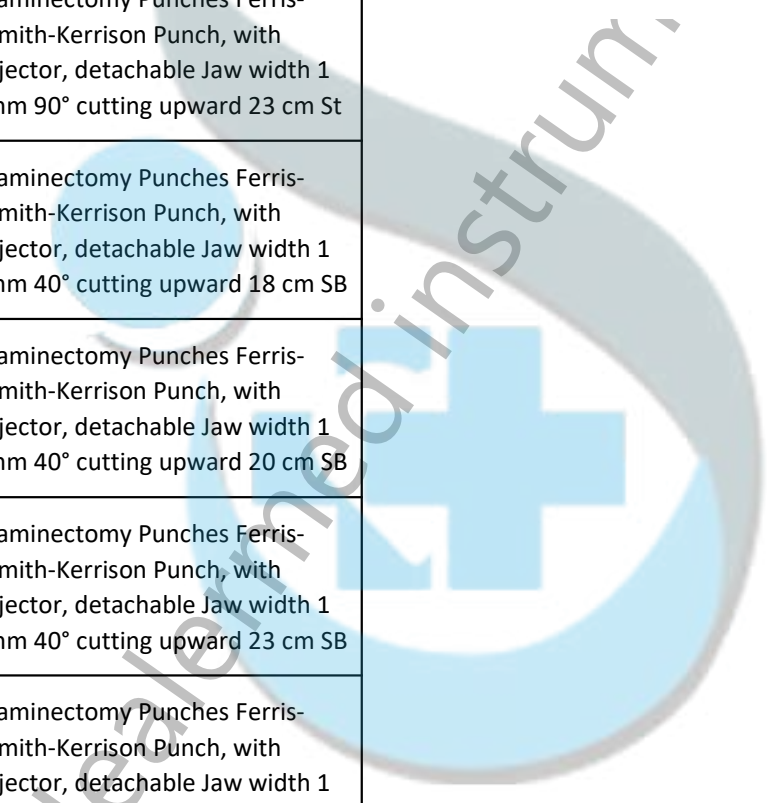

4908	HMI-SI-4879	Laminectomy Punches Ferris-Smith-Kerrison Punch, with ejector, detachable Jaw width 2 mm 40° cutting upward 18 cm St
4909	HMI-SI-4880	Laminectomy Punches Ferris-Smith-Kerrison Punch, with ejector, detachable Jaw width 2 mm 40° cutting upward 20 cm St
4910	HMI-SI-4881	Laminectomy Punches Ferris-Smith-Kerrison Punch, with ejector, detachable Jaw width 2 mm 40° cutting upward 23 cm St
4911	HMI-SI-4882	Laminectomy Punches Ferris-Smith-Kerrison Punch, with ejector, detachable Jaw width 2 mm 90° cutting upward 18 cm St
4912	HMI-SI-4883	Laminectomy Punches Ferris-Smith-Kerrison Punch, with ejector, detachable Jaw width 2 mm 90° cutting upward 20 cm St
4913	HMI-SI-4884	Laminectomy Punches Ferris-Smith-Kerrison Punch, with ejector, detachable Jaw width 2 mm 90° cutting upward 23 cm St
4914	HMI-SI-4885	Laminectomy Punches Ferris-Smith-Kerrison Punch, with ejector, detachable Jaw width 2 mm 40° cutting upward 18 cm SB
4915	HMI-SI-4886	Laminectomy Punches Ferris-Smith-Kerrison Punch, with ejector, detachable Jaw width 2 mm 40° cutting upward 20 cm SB
4916	HMI-SI-4887	Laminectomy Punches Ferris-Smith-Kerrison Punch, with ejector, detachable Jaw width 2 mm 40° cutting upward 23 cm SB
4917	HMI-SI-4888	Laminectomy Punches Ferris-Smith-Kerrison Punch, with ejector, detachable Jaw width 2 mm 90° cutting upward 18 cm SB

4918	HMI-SI-4889	Laminectomy Punches Ferris-Smith-Kerrison Punch, with ejector, detachable Jaw width 2 mm 90° cutting upward 20 cm SB
4919	HMI-SI-4890	Laminectomy Punches Ferris-Smith-Kerrison Punch, with ejector, detachable Jaw width 2 mm 90° cutting upward 23 cm SB
4920	HMI-SI-4891	Laminectomy Punches Ferris-Smith-Kerrison Punch, with ejector, detachable Jaw width 3 mm 40° cutting upward 18 cm St
4921	HMI-SI-4892	Laminectomy Punches Ferris-Smith-Kerrison Punch, with ejector, detachable Jaw width 3 mm 40° cutting upward 20 cm St
4922	HMI-SI-4893	Laminectomy Punches Ferris-Smith-Kerrison Punch, with ejector, detachable Jaw width 3 mm 40° cutting upward 23 cm St
4923	HMI-SI-4894	Laminectomy Punches Ferris-Smith-Kerrison Punch, with ejector, detachable Jaw width 3 mm 90° cutting upward 18 cm St
4924	HMI-SI-4895	Laminectomy Punches Ferris-Smith-Kerrison Punch, with ejector, detachable Jaw width 3 mm 90° cutting upward 20 cm St
4925	HMI-SI-4896	Laminectomy Punches Ferris-Smith-Kerrison Punch, with ejector, detachable Jaw width 3 mm 90° cutting upward 23 cm St
4926	HMI-SI-4897	Laminectomy Punches Ferris-Smith-Kerrison Punch, with ejector, detachable Jaw width 3 mm 40° cutting upward 18 cm SB

4927	HMI-SI-4898	Laminectomy Punches Ferris-Smith-Kerrison Punch, with ejector, detachable Jaw width 3 mm 40° cutting upward 20 cm SB
4928	HMI-SI-4899	Laminectomy Punches Ferris-Smith-Kerrison Punch, with ejector, detachable Jaw width 3 mm 40° cutting upward 23 cm SB
4929	HMI-SI-4900	Laminectomy Punches Ferris-Smith-Kerrison Punch, with ejector, detachable Jaw width 3 mm 90° cutting upward 18 cm SB
4930	HMI-SI-4901	Laminectomy Punches Ferris-Smith-Kerrison Punch, with ejector, detachable Jaw width 3 mm 90° cutting upward 20 cm SB
4931	HMI-SI-4902	Laminectomy Punches Ferris-Smith-Kerrison Punch, with ejector, detachable Jaw width 3 mm 90° cutting upward 23 cm SB
4932	HMI-SI-4903	Laminectomy Punches Ferris-Smith-Kerrison Punch, with ejector, detachable Jaw width 4 mm 40° cutting upward 18 cm St
4933	HMI-SI-4904	Laminectomy Punches Ferris-Smith-Kerrison Punch, with ejector, detachable Jaw width 4 mm 40° cutting upward 20 cm St
4934	HMI-SI-4905	Laminectomy Punches Ferris-Smith-Kerrison Punch, with ejector, detachable Jaw width 4 mm 40° cutting upward 23 cm St

4935	HMI-SI-4906	Laminectomy Punches Ferris-Smith-Kerrison Punch, with ejector, detachable Jaw width 4 mm 90° cutting upward 18 cm St
4936	HMI-SI-4907	Laminectomy Punches Ferris-Smith-Kerrison Punch, with ejector, detachable Jaw width 4 mm 90° cutting upward 20 cm St
4937	HMI-SI-4908	Laminectomy Punches Ferris-Smith-Kerrison Punch, with ejector, detachable Jaw width 4 mm 90° cutting upward 23 cm St
4938	HMI-SI-4909	Laminectomy Punches Ferris-Smith-Kerrison Punch, with ejector, detachable Jaw width 4 mm 40° cutting upward 18 cm SB
4939	HMI-SI-4910	Laminectomy Punches Ferris-Smith-Kerrison Punch, with ejector, detachable Jaw width 4 mm 40° cutting upward 20 cm SB
4940	HMI-SI-4911	Laminectomy Punches Ferris-Smith-Kerrison Punch, with ejector, detachable Jaw width 4 mm 40° cutting upward 23 cm SB
4941	HMI-SI-4912	Laminectomy Punches Ferris-Smith-Kerrison Punch, with ejector, detachable Jaw width 4 mm 90° cutting upward 18 cm SB
4942	HMI-SI-4913	Laminectomy Punches Ferris-Smith-Kerrison Punch, with ejector, detachable Jaw width 4 mm 90° cutting upward 20 cm SB

4943	HMI-SI-4914	Laminectomy Punches Ferris-Smith-Kerrison Punch, with ejector, detachable Jaw width 4 mm 90° cutting upward 23 cm SB
4944	HMI-SI-4915	Laminectomy Punches Ferris-Smith-Kerrison Punch, with ejector, detachable Jaw width 5 mm 40° cutting upward 18 cm St
4945	HMI-SI-4916	Laminectomy Punches Ferris-Smith-Kerrison Punch, with ejector, detachable Jaw width 5 mm 40° cutting upward 20 cm St
4946	HMI-SI-4917	Laminectomy Punches Ferris-Smith-Kerrison Punch, with ejector, detachable Jaw width 5 mm 40° cutting upward 23 cm St
4947	HMI-SI-4918	Laminectomy Punches Ferris-Smith-Kerrison Punch, with ejector, detachable Jaw width 5 mm 90° cutting upward 18 cm St
4948	HMI-SI-4919	Laminectomy Punches Ferris-Smith-Kerrison Punch, with ejector, detachable Jaw width 5 mm 90° cutting upward 20 cm St
4949	HMI-SI-4920	Laminectomy Punches Ferris-Smith-Kerrison Punch, with ejector, detachable Jaw width 5 mm 90° cutting upward 23 cm St
4950	HMI-SI-4921	Laminectomy Punches Ferris-Smith-Kerrison Punch, with ejector, detachable Jaw width 5 mm 40° cutting upward 18 cm SB

4951	HMI-SI-4922	Laminectomy Punches Ferris-Smith-Kerrison Punch, with ejector, detachable Jaw width 5 mm 40° cutting upward 20 cm SB
4952	HMI-SI-4923	Laminectomy Punches Ferris-Smith-Kerrison Punch, with ejector, detachable Jaw width 5 mm 40° cutting upward 23 cm SB
4953	HMI-SI-4924	Laminectomy Punches Ferris-Smith-Kerrison Punch, with ejector, detachable Jaw width 5 mm 90° cutting upward 18 cm SB
4954	HMI-SI-4925	Laminectomy Punches Ferris-Smith-Kerrison Punch, with ejector, detachable Jaw width 5 mm 90° cutting upward 20 cm SB
4955	HMI-SI-4926	Laminectomy Punches Ferris-Smith-Kerrison Punch, with ejector, detachable Jaw width 5 mm 90° cutting upward 23 cm SB
4956	HMI-SI-4927	Laminectomy Punches Ferris-Smith-Kerrison Punch, with ejector, detachable Jaw width 6 mm 40° cutting upward 18 cm St
4957	HMI-SI-4928	Laminectomy Punches Ferris-Smith-Kerrison Punch, with ejector, detachable Jaw width 6 mm 40° cutting upward 20 cm St
4958	HMI-SI-4929	Laminectomy Punches Ferris-Smith-Kerrison Punch, with ejector, detachable Jaw width 6 mm 40° cutting upward 23 cm St

4959	HMI-SI-4930	Laminectomy Punches Ferris-Smith-Kerrison Punch, with ejector, detachable Jaw width 6 mm 90° cutting upward 18 cm St
4960	HMI-SI-4931	Laminectomy Punches Ferris-Smith-Kerrison Punch, with ejector, detachable Jaw width 6 mm 90° cutting upward 20 cm St
4961	HMI-SI-4932	Laminectomy Punches Ferris-Smith-Kerrison Punch, with ejector, detachable Jaw width 6 mm 90° cutting upward 23 cm St
4962	HMI-SI-4933	Laminectomy Punches Ferris-Smith-Kerrison Punch, with ejector, detachable Jaw width 5 mm 40° cutting upward 18 cm SB
4963	HMI-SI-4934	Laminectomy Punches Ferris-Smith-Kerrison Punch, with ejector, detachable Jaw width 6 mm 40° cutting upward 20 cm SB
4964	HMI-SI-4935	Laminectomy Punches Ferris-Smith-Kerrison Punch, with ejector, detachable Jaw width 6 mm 40° cutting upward 23 cm SB
4965	HMI-SI-4936	Laminectomy Punches Ferris-Smith-Kerrison Punch, with ejector, detachable Jaw width 6 mm 90° cutting upward 18 cm SB
4966	HMI-SI-4937	Laminectomy Punches Ferris-Smith-Kerrison Punch, with ejector, detachable Jaw width 6 mm 90° cutting upward 20 cm SB

4967	HMI-SI-4938	Laminectomy Punches Ferris-Smith-Kerrison Punch, with ejector, detachable Jaw width 6 mm 90° cutting upward 23 cm SB
4968	HMI-SI-4945	Laminectomy Punches Ferris-Smith-Kerrison Punch, with ejector, detachable, thin plate Jaw width 1 mm 40° cutting downward St 20 cm
4969	HMI-SI-4946	Laminectomy Punches Ferris-Smith-Kerrison Punch, with ejector, detachable, thin plate Jaw width 1 mm 90° cutting downward St 20 cm
4970	HMI-SI-4947	Laminectomy Punches Ferris-Smith-Kerrison Punch, with ejector, detachable, thin plate Jaw width 1 mm 40° cutting downward SB 20 cm
4971	HMI-SI-4948	Laminectomy Punches Ferris-Smith-Kerrison Punch, with ejector, detachable, thin plate Jaw width 2mm 40° cutting downward St 20 cm
4972	HMI-SI-4949	Laminectomy Punches Ferris-Smith-Kerrison Punch, with ejector, detachable, thin plate Jaw width 2mm 40° cutting downward SB 20 cm
4973	HMI-SI-4950	Laminectomy Punches Ferris-Smith-Kerrison Punch, with ejector, detachable, thin plate Jaw width 3mm 40° cutting downward St 20 cm
4974	HMI-SI-4951	Laminectomy Punches Ferris-Smith-Kerrison Punch, with ejector, detachable, thin plate Jaw width 3mm 40° cutting downward SB 20 cm



4975	HMI-SI-4952	Laminectomy Punches Ferris-Smith-Kerrison Punch, with ejector, detachable, thin plate Jaw width 4mm 40° cutting downward St 20 cm
4976	HMI-SI-4953	Laminectomy Punches Ferris-Smith-Kerrison Punch, with ejector, detachable, thin plate Jaw width 4mm 40° cutting downward SB 20 cm
4977	HMI-SI-4954	Laminectomy Punches Ferris-Smith-Kerrison Punch, with ejector, detachable, thin plate Jaw width 5mm 40° cutting downward St 20 cm
4978	HMI-SI-4955	Laminectomy Punches Ferris-Smith-Kerrison Punch, with ejector, detachable, thin plate Jaw width 5mm 40° cutting downward SB 20 cm
4979	HMI-SI-4956	Laminectomy Punches Ferris-Smith-Kerrison Punch, with ejector, detachable, thin plate Jaw width 6mm 40° cutting downward St 20 cm
4980	HMI-SI-4957	Laminectomy Punches Ferris-Smith-Kerrison Punch, with ejector, detachable, thin plate Jaw width 6mm 40° cutting downward SB 20 cm
4981	HMI-SI-4958	Laminectomy Punches Ferris-Smith-Kerrison Punch, with ejector, detachable, thin plate Jaw width 2mm 90° cutting downward St 20 cm
4982	HMI-SI-4959	Laminectomy Punches Ferris-Smith-Kerrison Punch, with ejector, detachable, thin plate Jaw width 3mm 90° cutting downward St 20 cm

4983	HMI-SI-4960	Laminectomy Punches Ferris-Smith-Kerrison Punch, with ejector, detachable, thin plate Jaw width 4mm 90° cutting downward St 20 cm
4984	HMI-SI-4961	Laminectomy Punches Ferris-Smith-Kerrison Punch, with ejector, detachable, thin plate Jaw width 5mm 90° cutting downward St 20 cm
4985	HMI-SI-4962	Laminectomy Punches Ferris-Smith-Kerrison Punch, with ejector, detachable, thin plate Jaw width 6mm 90° cutting downward St 20 cm
4986	HMI-SI-4963	Laminectomy Punches Ferris-Smith-Kerrison Punch, with ejector, detachable, Jaw width 1mm 40° cutting upward, bayonet 15 cm St
4987	HMI-SI-4964	Laminectomy Punches Ferris-Smith-Kerrison Punch, with ejector, detachable, Jaw width 1mm 40° cutting upward, bayonet 18 cm St
4988	HMI-SI-4965	Laminectomy Punches Ferris-Smith-Kerrison Punch, with ejector, detachable, Jaw width 1mm 90° cutting upward, bayonet 15 cm St
4989	HMI-SI-4966	Laminectomy Punches Ferris-Smith-Kerrison Punch, with ejector, detachable, Jaw width 1mm 90° cutting upward, bayonet 18 cm St
4990	HMI-SI-4967	Laminectomy Punches Ferris-Smith-Kerrison Punch, with ejector, detachable, Jaw width 1mm 40° cutting upward, bayonet 15 cm SB



4991	HMI-SI-4968	Laminectomy Punches Ferris-Smith-Kerrison Punch, with ejector, detachable, Jaw width 1mm 40° cutting upward, bayonet 18 cm SB
4992	HMI-SI-4969	Laminectomy Punches Ferris-Smith-Kerrison Punch, with ejector, detachable, Jaw width 1mm 90° cutting upward, bayonet 15 cm SB
4993	HMI-SI-4970	Laminectomy Punches Ferris-Smith-Kerrison Punch, with ejector, detachable, Jaw width 1mm 90° cutting upward, bayonet 18 cm SB
4994	HMI-SI-4971	Laminectomy Punches Ferris-Smith-Kerrison Punch, with ejector, detachable, Jaw width 2mm 40° cutting upward, bayonet 15 cm St
4995	HMI-SI-4972	Laminectomy Punches Ferris-Smith-Kerrison Punch, with ejector, detachable, Jaw width 2mm 40° cutting upward, bayonet 18 cm St
4996	HMI-SI-4973	Laminectomy Punches Ferris-Smith-Kerrison Punch, with ejector, detachable, Jaw width 2mm 90° cutting upward, bayonet 15 cm St
4997	HMI-SI-4974	Laminectomy Punches Ferris-Smith-Kerrison Punch, with ejector, detachable, Jaw width 2mm 90° cutting upward, bayonet 18 cm St
4998	HMI-SI-4975	Laminectomy Punches Ferris-Smith-Kerrison Punch, with ejector, detachable, Jaw width 2mm 40° cutting upward, bayonet 15 cm SB

4999	HMI-SI-4976	Laminectomy Punches Ferris-Smith-Kerrison Punch, with ejector, detachable, Jaw width 2mm 40° cutting upward, bayonet 18 cm SB
5000	HMI-SI-4977	Laminectomy Punches Ferris-Smith-Kerrison Punch, with ejector, detachable, Jaw width 2mm 90° cutting upward, bayonet 15 cm SB
5001	HMI-SI-4978	Laminectomy Punches Ferris-Smith-Kerrison Punch, with ejector, detachable, Jaw width 2mm 90° cutting upward, bayonet 18 cm SB
5002	HMI-SI-4979	Laminectomy Punches Ferris-Smith-Kerrison Punch, with ejector, detachable, Jaw width 3mm 40° cutting upward, bayonet 15 cm St
5003	HMI-SI-4980	Laminectomy Punches Ferris-Smith-Kerrison Punch, with ejector, detachable, Jaw width 3mm 40° cutting upward, bayonet 18 cm St
5004	HMI-SI-4981	Laminectomy Punches Ferris-Smith-Kerrison Punch, with ejector, detachable, Jaw width 3mm 90° cutting upward, bayonet 15 cm St
5005	HMI-SI-4982	Laminectomy Punches Ferris-Smith-Kerrison Punch, with ejector, detachable, Jaw width 3mm 90° cutting upward, bayonet 18 cm St
5006	HMI-SI-4983	Laminectomy Punches Ferris-Smith-Kerrison Punch, with ejector, detachable, Jaw width 3mm 40° cutting upward, bayonet 15 cm SB

5007	HMI-SI-4984	Laminectomy Punches Ferris-Smith-Kerrison Punch, with ejector, detachable, Jaw width 3mm 40° cutting upward, bayonet 18 cm SB
5008	HMI-SI-4985	Laminectomy Punches Ferris-Smith-Kerrison Punch, with ejector, detachable, Jaw width 3mm 90° cutting upward, bayonet 15 cm SB
5009	HMI-SI-4986	Laminectomy Punches Ferris-Smith-Kerrison Punch, with ejector, detachable, Jaw width 3mm 90° cutting upward, bayonet 18 cm SB
5010	HMI-SI-4987	Laminectomy Punches Ferris-Smith-Kerrison Punch, with ejector, detachable, Jaw width 4mm 40° cutting upward, bayonet 15 cm St
5011	HMI-SI-4988	Laminectomy Punches Ferris-Smith-Kerrison Punch, with ejector, detachable, Jaw width 4mm 40° cutting upward, bayonet 18 cm St
5012	HMI-SI-4989	Laminectomy Punches Ferris-Smith-Kerrison Punch, with ejector, detachable, Jaw width 4mm 90° cutting upward, bayonet 15 cm St
5013	HMI-SI-4990	Laminectomy Punches Ferris-Smith-Kerrison Punch, with ejector, detachable, Jaw width 4mm 90° cutting upward, bayonet 18 cm St
5014	HMI-SI-4991	Laminectomy Punches Ferris-Smith-Kerrison Punch, with ejector, detachable, Jaw width 4mm 40° cutting upward, bayonet 15 cm SB

5015	HMI-SI-4992	Laminectomy Punches Ferris-Smith-Kerrison Punch, with ejector, detachable, Jaw width 4mm 40° cutting upward, bayonet 18 cm SB
5016	HMI-SI-4993	Laminectomy Punches Ferris-Smith-Kerrison Punch, with ejector, detachable, Jaw width 4mm 90° cutting upward, bayonet 15 cm SBt
5017	HMI-SI-4994	Laminectomy Punches Ferris-Smith-Kerrison Punch, with ejector, detachable, Jaw width 4mm 90° cutting upward, bayonet 18 cm SB
5018	HMI-SI-4995	Laminectomy Punches Ferris-Smith-Kerrison Punch, with ejector, detachable, Jaw width 5mm 40° cutting upward, bayonet 15 cm St
5019	HMI-SI-4996	Laminectomy Punches Ferris-Smith-Kerrison Punch, with ejector, detachable, Jaw width 5mm 40° cutting upward, bayonet 18 cm St
5020	HMI-SI-4997	Laminectomy Punches Ferris-Smith-Kerrison Punch, with ejector, detachable, Jaw width 5mm 90° cutting upward, bayonet 15 cm St
5021	HMI-SI-4998	Laminectomy Punches Ferris-Smith-Kerrison Punch, with ejector, detachable, Jaw width 5mm 90° cutting upward, bayonet 18 cm St
5022	HMI-SI-4999	Laminectomy Punches Ferris-Smith-Kerrison Punch, with ejector, detachable, Jaw width 5mm 40° cutting upward, bayonet 15 cm SB

5023	HMI-SI-5000	Laminectomy Punches Ferris-Smith-Kerrison Punch, with ejector, detachable, Jaw width 5mm 40° cutting upward, bayonet 18 cm SB
5024	HMI-SI-5001	Laminectomy Punches Ferris-Smith-Kerrison Punch, with ejector, detachable, Jaw width 5mm 90° cutting upward, bayonet 15 cm SB
5025	HMI-SI-5002	Laminectomy Punches Ferris-Smith-Kerrison Punch, with ejector, detachable, Jaw width 5mm 90° cutting upward, bayonet 18 cm SB
5026	HMI-SI-5003	Laminectomy Punches Ferris-Smith-Kerrison Punch, with ejector, detachable thin plate, Jaw width 1mm 40° cutting upward, bayonet 15 cm St
5027	HMI-SI-5004	Laminectomy Punches Ferris-Smith-Kerrison Punch, with ejector, detachable, thin plate Jaw width 1mm 40° cutting upward, bayonet 18 cm St
5028	HMI-SI-5005	Laminectomy Punches Ferris-Smith-Kerrison Punch, with ejector, detachable, thin plate Jaw width 1mm 90° cutting upward, bayonet 15 cm St
5029	HMI-SI-5006	Laminectomy Punches Ferris-Smith-Kerrison Punch, with ejector, detachable, thin plate Jaw width 1mm 90° cutting upward, bayonet 18 cm St
5030	HMI-SI-5007	Laminectomy Punches Ferris-Smith-Kerrison Punch, with ejector, detachable, thin plate Jaw width 1mm 40° cutting upward, bayonet 15 cm SB



5031	HMI-SI-5008	Laminectomy Punches Ferris-Smith-Kerrison Punch, with ejector, detachable, thin plate Jaw width 1mm 40° cutting upward, bayonet 18 cm SB
5032	HMI-SI-5009	Laminectomy Punches Ferris-Smith-Kerrison Punch, with ejector, detachable, thin plate Jaw width 1mm 90° cutting upward, bayonet 15 cm SB
5033	HMI-SI-5010	Laminectomy Punches Ferris-Smith-Kerrison Punch, with ejector, detachable, thin plate Jaw width 1mm 90° cutting upward, bayonet 18 cm SB
5034	HMI-SI-5011	Laminectomy Punches Ferris-Smith-Kerrison Punch, with ejector, detachable, thin plate Jaw width 2mm 40° cutting upward, bayonet 15 cm St
5035	HMI-SI-5012	Laminectomy Punches Ferris-Smith-Kerrison Punch, with ejector, detachable, thin plate Jaw width 2mm 40° cutting upward, bayonet 18 cm St
5036	HMI-SI-5013	Laminectomy Punches Ferris-Smith-Kerrison Punch, with ejector, detachable, thin plate Jaw width 2mm 90° cutting upward, bayonet 15 cm St
5037	HMI-SI-5014	Laminectomy Punches Ferris-Smith-Kerrison Punch, with ejector, detachable, thin plate Jaw width 2mm 90° cutting upward, bayonet 18 cm St
5038	HMI-SI-5015	Laminectomy Punches Ferris-Smith-Kerrison Punch, with ejector, detachable, thin plate Jaw width 2mm 40° cutting upward, bayonet 15 cm SB

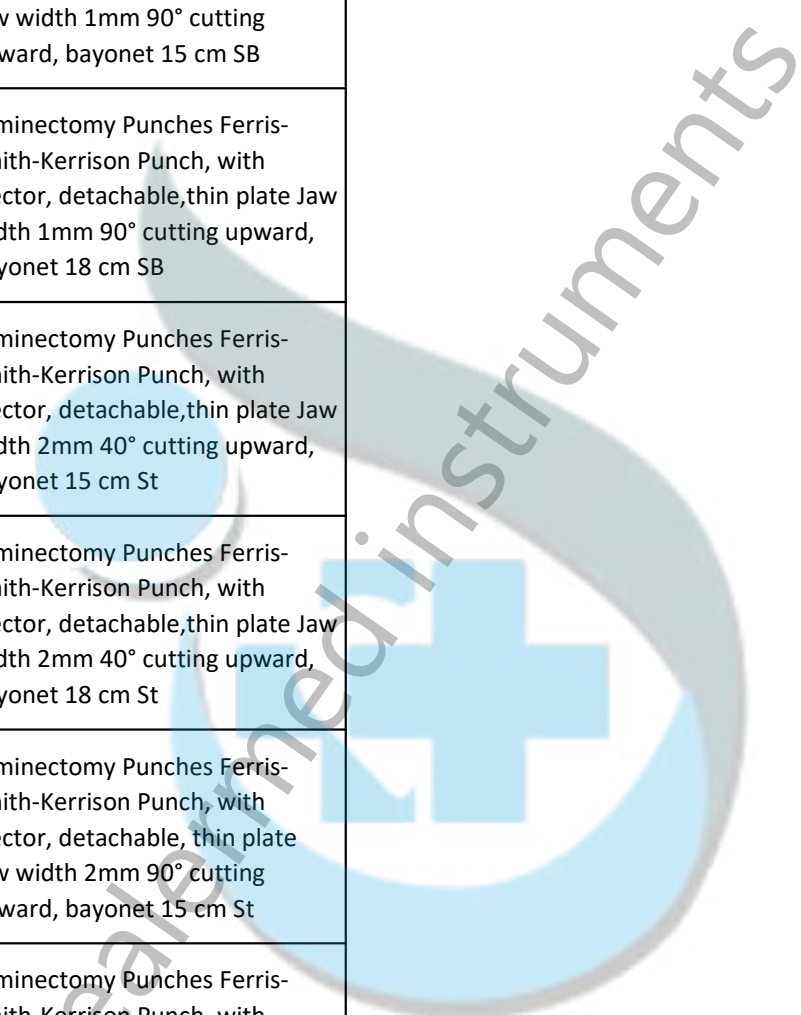

5039	HMI-SI-5016	Laminectomy Punches Ferris-Smith-Kerrison Punch, with ejector, detachable, thin plate Jaw width 2mm 40° cutting upward, bayonet 18 cm SB
5040	HMI-SI-5017	Laminectomy Punches Ferris-Smith-Kerrison Punch, with ejector, detachable, thin plate Jaw width 2mm 90° cutting upward, bayonet 15 cm SB
5041	HMI-SI-5018	Laminectomy Punches Ferris-Smith-Kerrison Punch, with ejector, detachable, thin plate Jaw width 2mm 90° cutting upward, bayonet 18 cm SB
5042	HMI-SI-5019	Laminectomy Punches Ferris-Smith-Kerrison Punch, with ejector, detachable, thin plate Jaw width 3mm 40° cutting upward, bayonet 15 cm St
5043	HMI-SI-5020	Laminectomy Punches Ferris-Smith-Kerrison Punch, with ejector, detachable, thin plate Jaw width 3mm 40° cutting upward, bayonet 18 cm St
5044	HMI-SI-5021	Laminectomy Punches Ferris-Smith-Kerrison Punch, with ejector, detachable, thin plate Jaw width 3mm 90° cutting upward, bayonet 15 cm St
5045	HMI-SI-5022	Laminectomy Punches Ferris-Smith-Kerrison Punch, with ejector, detachable, thin plate Jaw width 3mm 90° cutting upward, bayonet 18 cm St
5046	HMI-SI-5023	Laminectomy Punches Ferris-Smith-Kerrison Punch, with ejector, detachable, thin plate Jaw width 3mm 40° cutting upward, bayonet 15 cm SB

5047	HMI-SI-5024	Laminectomy Punches Ferris-Smith-Kerrison Punch, with ejector, detachable, thin plate Jaw width 3mm 40° cutting upward, bayonet 18 cm SB
5048	HMI-SI-5025	Laminectomy Punches Ferris-Smith-Kerrison Punch, with ejector, detachable, thin plate Jaw width 3mm 90° cutting upward, bayonet 15 cm SB
5049	HMI-SI-5026	Laminectomy Punches Ferris-Smith-Kerrison Punch, with ejector, detachable, thin plate Jaw width 3mm 90° cutting upward, bayonet 18 cm SB
5050	HMI-SI-5027	Laminectomy Punches Ferris-Smith-Kerrison Punch, with ejector, detachable, thin plate Jaw width 4mm 40° cutting upward, bayonet 15 cm St
5051	HMI-SI-5028	Laminectomy Punches Ferris-Smith-Kerrison Punch, with ejector, detachable, thin plate Jaw width 4mm 40° cutting upward, bayonet 18 cm St
5052	HMI-SI-5029	Laminectomy Punches Ferris-Smith-Kerrison Punch, with ejector, detachable, thin plate Jaw width 4mm 90° cutting upward, bayonet 15 cm St
5053	HMI-SI-5030	Laminectomy Punches Ferris-Smith-Kerrison Punch, with ejector, detachable, thin plate Jaw width 4mm 90° cutting upward, bayonet 18 cm St
5054	HMI-SI-5031	Laminectomy Punches Ferris-Smith-Kerrison Punch, with ejector, detachable, thin plate Jaw width 4mm 40° cutting upward, bayonet 15 cm SB

5055	HMI-SI-5032	Laminectomy Punches Ferris-Smith-Kerrison Punch, with ejector, detachable, thin plate Jaw width 4mm 40° cutting upward, bayonet 18 cm SB
5056	HMI-SI-5033	Laminectomy Punches Ferris-Smith-Kerrison Punch, with ejector, detachable, thin plate Jaw width 4mm 90° cutting upward, bayonet 15 cm SBt
5057	HMI-SI-5034	Laminectomy Punches Ferris-Smith-Kerrison Punch, with ejector, detachable, thin plate Jaw width 4mm 90° cutting upward, bayonet 18 cm SB
5058	HMI-SI-5035	Laminectomy Punches Ferris-Smith-Kerrison Punch, with ejector, detachable, thin plate Jaw width 5mm 40° cutting upward, bayonet 15 cm St
5059	HMI-SI-5036	Laminectomy Punches Ferris-Smith-Kerrison Punch, with ejector, detachable, thin plate Jaw width 5mm 40° cutting upward, bayonet 18 cm St
5060	HMI-SI-5037	Laminectomy Punches Ferris-Smith-Kerrison Punch, with ejector, detachable, thin plate Jaw width 5mm 90° cutting upward, bayonet 15 cm St
5061	HMI-SI-5038	Laminectomy Punches Ferris-Smith-Kerrison Punch, with ejector, detachable, thin plate Jaw width 5mm 90° cutting upward, bayonet 18 cm St
5062	HMI-SI-5039	Laminectomy Punches Ferris-Smith-Kerrison Punch, with ejector, detachable, thin plate Jaw width 5mm 40° cutting upward, bayonet 15 cm SB

5063	HMI-SI-5040	Laminectomy Punches Ferris-Smith-Kerrison Punch, with ejector, detachable, thin plate Jaw width 5mm 40° cutting upward, bayonet 18 cm SB
5064	HMI-SI-5041	Laminectomy Punches Ferris-Smith-Kerrison Punch, with ejector, detachable, thin plate Jaw width 5mm 90° cutting upward, bayonet 15 cm SB
5065	HMI-SI-5042	Laminectomy Punches Ferris-Smith-Kerrison Punch, with ejector, detachable, thin plate Jaw width 5mm 90° cutting upward, bayonet 18 cm SB
5066	HMI-SI-5043	Laminectomy Punches Ferris-Smith-Kerrison Punch, with ejector, detachable, thin plate Jaw width 1mm 90° cutting upward, bayonet 18 cm St
5067	HMI-SI-5044	Laminectomy Punches Ferris-Smith-Kerrison Punch, with ejector, detachable, thin plate Jaw width 1mm 90° cutting upward, bayonet 18 cm SB
5068	HMI-SI-5045	Laminectomy Punches Ferris-Smith-Kerrison Punch, with ejector, detachable, thin plate Jaw width 2mm 90° cutting upward, bayonet 18 cm St
5069	HMI-SI-5046	Laminectomy Punches Ferris-Smith-Kerrison Punch, with ejector, detachable, thin plate Jaw width 2mm 90° cutting upward, bayonet 18 cm SB
5070	HMI-SI-5047	Laminectomy Punches Ferris-Smith-Kerrison Punch, with ejector, detachable, thin plate Jaw width 3mm 90° cutting upward, bayonet 18 cm St



5071	HMI-SI-5048	Laminectomy Punches Ferris-Smith-Kerrison Punch, with ejector, detachable, thin plate Jaw width 3mm 90° cutting upward, bayonet 18 cm SB
5072	HMI-SI-5049	Laminectomy Punches Ferris-Smith-Kerrison Punch, with ejector, detachable, thin plate Jaw width 4mm 90° cutting upward, bayonet 18 cm St
5073	HMI-SI-5050	Laminectomy Punches Ferris-Smith-Kerrison Punch, with ejector, detachable, thin plate Jaw width 4mm 90° cutting upward, bayonet 18 cm SB
5074	HMI-SI-5051	Laminectomy Punches Ferris-Smith-Kerrison Punch, with ejector, detachable, thin plate Jaw width 5mm 90° cutting upward, bayonet 18 cm St
5075	HMI-SI-5052	Laminectomy Punches Ferris-Smith-Kerrison Punch, with ejector, detachable, thin plate Jaw width 5mm 90° cutting upward, bayonet 18 cm SB
5076	HMI-SI-5053	Laminectomy Punches Ferris-Smith-Kerrison Punch, with ejector, detachable, long stroke, thin plate Jaw width 1mm 90° cutting upward, bayonet 18 cm St
5077	HMI-SI-5054	Laminectomy Punches Ferris-Smith-Kerrison Punch, with ejector, detachable, long stroke, thin plate Jaw width 1mm 90° cutting upward, bayonet 18 cm SB
5078	HMI-SI-5055	Laminectomy Punches Ferris-Smith-Kerrison Punch, with ejector, detachable, long stroke, thin plate Jaw width 2mm 90° cutting upward, bayonet 18 cm St

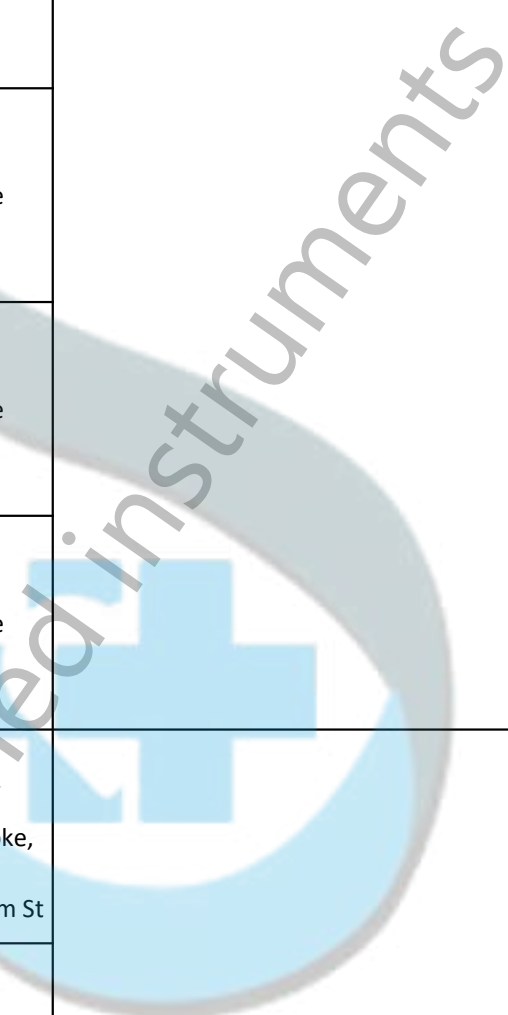

5079	HMI-SI-5056	Laminectomy Punches Ferris-Smith-Kerrison Punch, with ejector, detachable, long stroke, thin plate Jaw width 2mm 90° cutting upward, bayonet 18 cm SB
5080	HMI-SI-5057	Laminectomy Punches Ferris-Smith-Kerrison Punch, with ejector, detachable, long stroke, thin plate Jaw width 3mm 90° cutting upward, bayonet 18 cm St
5081	HMI-SI-5058	Laminectomy Punches Ferris-Smith-Kerrison Punch, with ejector, detachable, long stroke, thin plate Jaw width 3mm 90° cutting upward, bayonet 18 cm SB
5082	HMI-SI-5059	Laminectomy Punches Ferris-Smith-Kerrison Punch, with ejector, detachable, long stroke, thin plate Jaw width 4mm 90° cutting upward, bayonet 18 cm St
5083	HMI-SI-5060	Laminectomy Punches Ferris-Smith-Kerrison Punch, with ejector, detachable, long stroke, thin plate Jaw width 4mm 90° cutting upward, bayonet 18 cm SB
5084	HMI-SI-5061	Laminectomy Punches Ferris-Smith-Kerrison Punch, with ejector, detachable, long stroke, thin plate Jaw width 5mm 90° cutting upward, bayonet 18 cm St
5085	HMI-SI-5062	Laminectomy Punches Ferris-Smith-Kerrison Punch, with ejector, detachable, long stroke, thin plate Jaw width 5mm 90° cutting upward, bayonet 18 cm SB
5086	HMI-SI-5063	Laminectomy Punches Ferris-Smith-Kerrison Punch, with ejector, detachable, Jaw width 1mm 40° cutting upward, 20 cm St



5087	HMI-SI-5064	Laminectomy Punches Ferris-Smith-Kerrison Punch, with ejector, detachable, Jaw width 1mm 40° cutting leftward, 20 cm St
5088	HMI-SI-5065	Laminectomy Punches Ferris-Smith-Kerrison Punch, with ejector, detachable, Jaw width 1mm 40° cutting rightward, 20 cm St
5089	HMI-SI-5065(a)	Laminectomy Punches Ferris-Smith-Kerrison Punch, with ejector, detachable, Jaw width 1mm 40° cutting upward, 20 cm SB
5090	HMI-SI-5065(b)	Laminectomy Punches Ferris-Smith-Kerrison Punch, with ejector, detachable, Jaw width 1mm 40° cutting leftward, 20 cm SB
5091	HMI-SI-5065(c)	Laminectomy Punches Ferris-Smith-Kerrison Punch, with ejector, detachable, Jaw width 1mm 40° cutting rightward, 20 cm SB
5092	HMI-SI-5066	Laminectomy Punches Ferris-Smith-Kerrison Punch, with ejector, detachable, Jaw width 2mm 40° cutting upward, 20 cm St
5093	HMI-SI-5067	Laminectomy Punches Ferris-Smith-Kerrison Punch, with ejector, detachable, Jaw width 2mm 40° cutting leftward, 20 cm St
5094	HMI-SI-5068	Laminectomy Punches Ferris-Smith-Kerrison Punch, with ejector, detachable, Jaw width 2mm 40° cutting rightward, 20 cm St



5095	HMI-SI-5069	Laminectomy Punches Ferris-Smith-Kerrison Punch, with ejector, detachable, Jaw width 2mm 40° cutting upward, 20 cm SB
5096	HMI-SI-5070	Laminectomy Punches Ferris-Smith-Kerrison Punch, with ejector, detachable, Jaw width 2mm 40° cutting leftward, 20 cm SB
5097	HMI-SI-5071	Laminectomy Punches Ferris-Smith-Kerrison Punch, with ejector, detachable, Jaw width 2mm 40° cutting rightward, 20 cm SB
5098	HMI-SI-5071(a)	Laminectomy Punches Ferris-Smith-Kerrison Punch, with ejector, detachable, Jaw width 3mm 40° cutting upward, 20 cm St
5099	HMI-SI-5072	Laminectomy Punches Ferris-Smith-Kerrison Punch, with ejector, detachable, Jaw width 3mm 40° cutting leftward, 20 cm St
5100	HMI-SI-5073	Laminectomy Punches Ferris-Smith-Kerrison Punch, with ejector, detachable, Jaw width 3mm 40° cutting rightward, 20 cm St
5101	HMI-SI-5074	Laminectomy Punches Ferris-Smith-Kerrison Punch, with ejector, detachable, Jaw width 3mm 40° cutting upward, 20 cm SB
5102	HMI-SI-5075	Laminectomy Punches Ferris-Smith-Kerrison Punch, with ejector, detachable, Jaw width 3mm 40° cutting leftward, 20 cm SB

5103	HMI-SI-5076	Laminectomy Punches Ferris-Smith-Kerrison Punch, with ejector, detachable, Jaw width 3mm 40° cutting rightward, 20 cm SB
5104	HMI-SI-5077	Laminectomy Punches Ferris-Smith-Kerrison Punch, with ejector, detachable, Jaw width 4mm 40° cutting upward, 20 cm St
5105	HMI-SI-5078	Laminectomy Punches Ferris-Smith-Kerrison Punch, with ejector, detachable, Jaw width 4mm 40° cutting leftward, 20 cm St
5106	HMI-SI-5079	Laminectomy Punches Ferris-Smith-Kerrison Punch, with ejector, detachable, Jaw width 4mm 40° cutting rightward, 20 cm St
5107	HMI-SI-5080	Laminectomy Punches Ferris-Smith-Kerrison Punch, with ejector, detachable, Jaw width 4mm 40° cutting upward, 20 cm SB
5108	HMI-SI-5081	Laminectomy Punches Ferris-Smith-Kerrison Punch, with ejector, detachable, Jaw width 4mm 40° cutting leftward, 20 cm SB
5109	HMI-SI-5082	Laminectomy Punches Ferris-Smith-Kerrison Punch, with ejector, detachable, Jaw width 4mm 40° cutting rightward, 20 cm SB
5110	HMI-SI-5083	Laminectomy Punches Ferris-Smith-Kerrison Punch, with ejector, detachable, Jaw width 5mm 40° cutting upward, 20 cm St

5111	HMI-SI-5084	Laminectomy Punches Ferris-Smith-Kerrison Punch, with ejector, detachable, Jaw width 5mm 40° cutting leftward, 20 cm St
5112	HMI-SI-5085	Laminectomy Punches Ferris-Smith-Kerrison Punch, with ejector, detachable, Jaw width 5mm 40° cutting rightward, 20 cm St
5113	HMI-SI-5086	Laminectomy Punches Ferris-Smith-Kerrison Punch, with ejector, detachable, Jaw width 5mm 40° cutting upward, 20 cm SB
5114	HMI-SI-5086(a)	Laminectomy Punches Ferris-Smith-Kerrison Punch, with ejector, detachable, Jaw width 5mm 40° cutting leftward, 20 cm SB
5115	HMI-SI-5086(b)	Laminectomy Punches Ferris-Smith-Kerrison Punch, with ejector, detachable, Jaw width 5mm 40° cutting rightward, 20 cm SB
5116	HMI-SI-5086(c)	Laminectomy Punches Ferris-Smith-Kerrison Punch, with ejector, detachable, Jaw width 3mm 40° curved, bayonet, 18 cm SB
5117	HMI-SI-5087	Rongeurs Caspar detachable Jaw width 2 mm straight 15 cm St
5118	HMI-SI-5087(a)	Rongeurs Caspar detachable Jaw width 2 mm straight 18 cm St
5119	HMI-SI-5087(b)	Rongeurs Caspar detachable Jaw width 2 mm straight 20 cm St



5120	HMI-SI-5087(c)	Rongeurs Caspar detachable Jaw width 2 mm straight 30 cm St
5121	HMI-SI-5087(d)	Rongeurs Caspar detachable Jaw width 2 mm straight 15 cm SB
5122	HMI-SI-5088	Rongeurs Caspar detachable Jaw width 2 mm straight 18 cm SB
5123	HMI-SI-5089	Rongeurs Caspar detachable Jaw width 2 mm straight 20 cm SB
5124	HMI-SI-5090	Rongeurs Caspar detachable Jaw width 2 mm straight 30 cm SB
5125	HMI-SI-5091	Rongeurs Caspar detachable Jaw width 3 mm straight 15 cm St
5126	HMI-SI-5092	Rongeurs Caspar detachable Jaw width 3 mm straight 18 cm St
5127	HMI-SI-5093	Rongeurs Caspar detachable Jaw width 3 mm straight 20 cm St
5128	HMI-SI-5094	Rongeurs Caspar detachable Jaw width 3 mm straight 30 cm St
5129	HMI-SI-5095	Rongeurs Caspar detachable Jaw width 3 mm straight 15 cm SB
5130	HMI-SI-5096	Rongeurs Caspar detachable Jaw width 3 mm straight 18 cm SB
5131	HMI-SI-5097	Rongeurs Caspar detachable Jaw width 3 mm straight 20 cm SB
5132	HMI-SI-5098	Rongeurs Caspar detachable Jaw width 3 mm straight 30 cm SB
5133	HMI-SI-5099	Rongeurs Caspar detachable Jaw width 4 mm straight 15 cm St
5134	HMI-SI-5100	Rongeurs Caspar detachable Jaw width 4 mm straight 18 cm St
5135	HMI-SI-5101	Rongeurs Caspar detachable Jaw width 4 mm straight 20 cm St



5136	HMI-SI-5102	Rongeurs Caspar detachable Jaw width 4 mm straight 30 cm St
5137	HMI-SI-5103	Rongeurs Caspar detachable Jaw width 4 mm straight 15 cm SB
5138	HMI-SI-5104	Rongeurs Caspar detachable Jaw width 4 mm straight 18 cm SB
5139	HMI-SI-5105	Rongeurs Caspar detachable Jaw width 4 mm straight 20 cm SB
5140	HMI-SI-5106	Rongeurs Caspar detachable Jaw width 4 mm straight 30 cm SB
5141	HMI-SI-5107	Rongeurs Caspar detachable Jaw width 5 mm straight 15 cm St
5142	HMI-SI-5108	Rongeurs Caspar detachable Jaw width 5 mm straight 18 cm St
5143	HMI-SI-5109	Rongeurs Caspar detachable Jaw width 5 mm straight 20 cm St
5144	HMI-SI-5110	Rongeurs Caspar detachable Jaw width 5 mm straight 30 cm St
5145	HMI-SI-5111	Rongeurs Caspar detachable Jaw width 5 mm straight 15 cm SB
5146	HMI-SI-5112	Rongeurs Caspar detachable Jaw width 5 mm straight 18 cm SB
5147	HMI-SI-5113	Rongeurs Caspar detachable Jaw width 5 mm straight 20 cm SB
5148	HMI-SI-5114	Rongeurs Caspar detachable Jaw width 5 mm straight 30 cm SB
5149	HMI-SI-5115	Rongeurs Caspar detachable Jaw width 2 mm 30° angled upward 15 cm St
5150	HMI-SI-5116	Rongeurs Caspar detachable Jaw width 2 mm 30° angled upward 18 cm St
5151	HMI-SI-5117	Rongeurs Caspar detachable Jaw width 2 mm 30° angled upward 20 cm St

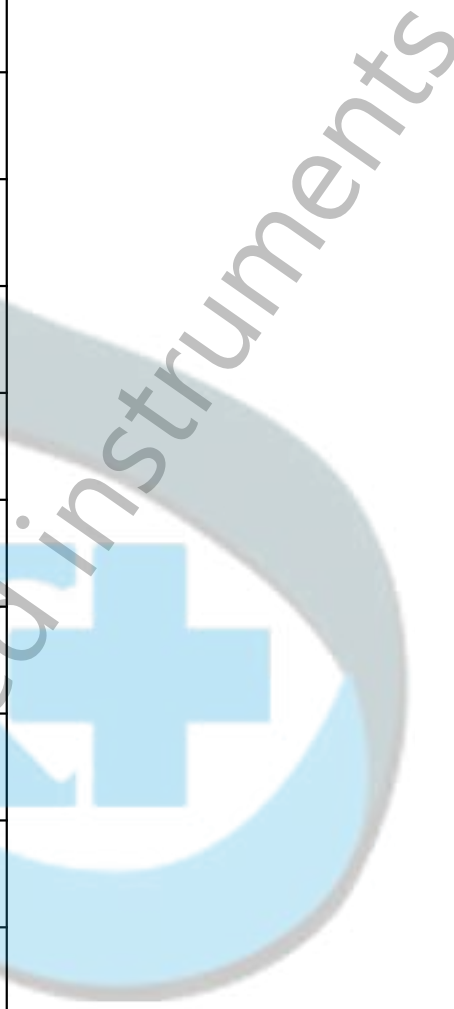

5152	HMI-SI-5118	Rongeurs Caspar detachable Jaw width 2 mm 30° angled upward 30 cm St
5153	HMI-SI-5119	Rongeurs Caspar detachable Jaw width 2 mm 30° angled upward 15 cm SB
5154	HMI-SI-5120	Rongeurs Caspar detachable Jaw width 2 mm 30° angled upward 18 cm SB
5155	HMI-SI-5121	Rongeurs Caspar detachable Jaw width 2 mm 30° angled upward 20 cm SB
5156	HMI-SI-5122	Rongeurs Caspar detachable Jaw width 2 mm 30° angled upward 30 cm SB
5157	HMI-SI-5123	Rongeurs Caspar detachable Jaw width 3 mm 30° angled upward 15 cm St
5158	HMI-SI-5124	Rongeurs Caspar detachable Jaw width 3mm 30° angled upward 18 cm St
5159	HMI-SI-5125	Rongeurs Caspar detachable Jaw width 3 mm 30° angled upward 20 cm St
5160	HMI-SI-5126	Rongeurs Caspar detachable Jaw width 3 mm 30° angled upward 30 cm St
5161	HMI-SI-5127	Rongeurs Caspar detachable Jaw width 3 mm 30° angled upward 15 cm SB
5162	HMI-SI-5128	Rongeurs Caspar detachable Jaw width 3 mm 30° angled upward 18 cm SB
5163	HMI-SI-5129	Rongeurs Caspar detachable Jaw width 3 mm 30° angled upward 20 cm SB
5164	HMI-SI-5130	Rongeurs Caspar detachable Jaw width 3 mm 30° angled upward 30 cm SB
5165	HMI-SI-5131	Rongeurs Caspar detachable Jaw width 4 mm 30° angled upward 15 cm St
5166	HMI-SI-5132	Rongeurs Caspar detachable Jaw width 4 mm 30° angled upward 18 cm St
5167	HMI-SI-5133	Rongeurs Caspar detachable Jaw width 4 mm 30° angled upward 20 cm St



5168	HMI-SI-5134	Rongeurs Caspar detachable Jaw width 4 mm 30° angled upward 30 cm St
5169	HMI-SI-5135	Rongeurs Caspar detachable Jaw width 4 mm 30° angled upward 15 cm SB
5170	HMI-SI-5136	Rongeurs Caspar detachable Jaw width 4 mm 30° angled upward 18 cm SB
5171	HMI-SI-5137	Rongeurs Caspar detachable Jaw width 4 mm 30° angled upward 20 cm SB
5172	HMI-SI-5138	Rongeurs Caspar detachable Jaw width 4 mm 30° angled upward 30 cm SB
5173	HMI-SI-5139	Rongeurs Caspar detachable Jaw width 5 mm 30° angled upward 15 cm St
5174	HMI-SI-5140	Rongeurs Caspar detachable Jaw width 5 mm 30° angled upward 18 cm St
5175	HMI-SI-5141	Rongeurs Caspar detachable Jaw width 5 mm 30° angled upward 20 cm St
5176	HMI-SI-5142	Rongeurs Caspar detachable Jaw width 5 mm 30° angled upward 30 cm St
5177	HMI-SI-5143	Rongeurs Caspar detachable Jaw width 5 mm 30° angled upward 15 cm SB
5178	HMI-SI-5144	Rongeurs Caspar detachable Jaw width 5 mm 30° angled upward 18 cm SB
5179	HMI-SI-5145	Rongeurs Caspar detachable Jaw width 5 mm 30° angled upward 20 cm SB
5180	HMI-SI-5146	Rongeurs Caspar detachable Jaw width 5 mm 30° angled upward 30 cm SB
5181	HMI-SI-5147	Rongeurs Caspar detachable Jaw width 2 mm 30° angled downward 15 cm St
5182	HMI-SI-5148	Rongeurs Caspar detachable Jaw width 2 mm 30° angled downward 18 cm St
5183	HMI-SI-5149	Rongeurs Caspar detachable Jaw width 2 mm 30° angled downward 20 cm St



5184	HMI-SI-5150	Rongeurs Caspar detachable Jaw width 2 mm 30° angled downward 30 cm St
5185	HMI-SI-5151	Rongeurs Caspar detachable Jaw width 2 mm 30° angled downward 15 cm SB
5186	HMI-SI-5152	Rongeurs Caspar detachable Jaw width 2 mm 30° angled downward 18 cm SB
5187	HMI-SI-5153	Rongeurs Caspar detachable Jaw width 2 mm 30° angled downward 20 cm SB
5188	HMI-SI-5154	Rongeurs Caspar detachable Jaw width 2 mm 30° angled downward 30 cm SB
5189	HMI-SI-5155	Rongeurs Caspar detachable Jaw width 3 mm 30° angled downward 15 cm St
5190	HMI-SI-5156	Rongeurs Caspar detachable Jaw width 3mm 30° angled downward 18 cm St
5191	HMI-SI-5157	Rongeurs Caspar detachable Jaw width 3 mm 30° angled downward 20 cm St
5192	HMI-SI-5158	Rongeurs Caspar detachable Jaw width 3 mm 30° angled downward 30 cm St
5193	HMI-SI-5159	Rongeurs Caspar detachable Jaw width 3 mm 30° angled downward 15 cm SB
5194	HMI-SI-5160	Rongeurs Caspar detachable Jaw width 3 mm 30° angled downward 18 cm SB
5195	HMI-SI-5161	Rongeurs Caspar detachable Jaw width 3 mm 30° angled downward 20 cm SB
5196	HMI-SI-5162	Rongeurs Caspar detachable Jaw width 3 mm 30° angled downward 30 cm SB
5197	HMI-SI-5163	Rongeurs Caspar detachable Jaw width 4 mm 30° angled downward 15 cm St
5198	HMI-SI-5164	Rongeurs Caspar detachable Jaw width 4 mm 30° angled downward 18 cm St
5199	HMI-SI-5165	Rongeurs Caspar detachable Jaw width 4 mm 30° angled downward 20 cm St



5200	HMI-SI-5166	Rongeurs Caspar detachable Jaw width 4 mm 30° angled downward 30 cm St
5201	HMI-SI-5167	Rongeurs Caspar detachable Jaw width 4 mm 30° angled downward 15 cm SB
5202	HMI-SI-5168	Rongeurs Caspar detachable Jaw width 4 mm 30° angled downward 18 cm SB
5203	HMI-SI-5169	Rongeurs Caspar detachable Jaw width 4 mm 30° angled downward 20 cm SB
5204	HMI-SI-5170	Rongeurs Caspar detachable Jaw width 4 mm 30° angled downward 30 cm SB
5205	HMI-SI-5171	Rongeurs Caspar detachable Jaw width 5 mm 30° angled downward 15 cm St
5206	HMI-SI-5172	Rongeurs Caspar detachable Jaw width 5 mm 30° angled downward 18 cm St
5207	HMI-SI-5173	Rongeurs Caspar detachable Jaw width 5 mm 30° angled downward 20 cm St
5208	HMI-SI-5174	Rongeurs Caspar detachable Jaw width 5 mm 30° angled downward 30 cm St
5209	HMI-SI-5175	Rongeurs Caspar detachable Jaw width 5 mm 30° angled downward 15 cm SB
5210	HMI-SI-5176	Rongeurs Caspar detachable Jaw width 5 mm 30° angled downward 18 cm SB
5211	HMI-SI-5177	Rongeurs Caspar detachable Jaw width 5 mm 30° angled downward 20 cm SB
5212	HMI-SI-5178	Rongeurs Caspar detachable Jaw width 5 mm 30° angled downward 30 cm SB
5213	HMI-SI-5179	Rongeurs Caspar detachable Jaw width 2 mm straight, bayonet 15 cm St
5214	HMI-SI-5180	Rongeurs Caspar detachable Jaw width 2 mm straight, bayonet 18 cm St
5215	HMI-SI-5181	Rongeurs Caspar detachable Jaw width 2 mm straight, bayonet 15 cm SB

5216	HMI-SI-5182	Rongeurs Caspar detachable Jaw width 2 mm straight, bayonet 18 cm SB
5217	HMI-SI-5183	Rongeurs Caspar detachable Jaw width 3 mm straight, bayonet 15 cm St
5218	HMI-SI-5184	Rongeurs Caspar detachable Jaw width 3 mm straight, bayonet 18 cm St
5219	HMI-SI-5185	Rongeurs Caspar detachable Jaw width 3 mm straight, bayonet 15 cm SB
5220	HMI-SI-5186	Rongeurs Caspar detachable Jaw width 3 mm straight, bayonet 18 cm SB
5221	HMI-SI-5187	Rongeurs Caspar detachable Jaw width 4 mm straight, bayonet 15 cm St
5222	HMI-SI-5188	Rongeurs Caspar detachable Jaw width 4 mm straight, bayonet 18 cm St
5223	HMI-SI-5189	Rongeurs Caspar detachable Jaw width 4 mm straight, bayonet 15 cm SB
5224	HMI-SI-5190	Rongeurs Caspar detachable Jaw width 4 mm straight, bayonet 18 cm SB
5225	HMI-SI-5191	Rongeurs Caspar detachable Jaw width 5 mm straight, bayonet 15 cm St
5226	HMI-SI-5192	Rongeurs Caspar detachable Jaw width 5 mm straight, bayonet 18 cm St
5227	HMI-SI-5193	Rongeurs Caspar detachable Jaw width 5 mm straight, bayonet 15 cm SB
5228	HMI-SI-5194	Rongeurs Caspar detachable Jaw width 5 mm straight, bayonet 18 cm SB
5229	HMI-SI-5195	Rongeurs Caspar detachable Jaw width 2 mm 30° angled upward, bayonet 15 cm St
5230	HMI-SI-5196	Rongeurs Caspar detachable Jaw width 2 mm 30° angled upward, bayonet 18 cm St
5231	HMI-SI-5197	Rongeurs Caspar detachable Jaw width 2 mm 30° angled upward, bayonet 15 cm SB







5232	HMI-SI-5198	Rongeurs Caspar detachable Jaw width 2 mm 30° angled upward, bayonet 18 cm SB
5233	HMI-SI-5199	Rongeurs Caspar detachable Jaw width 3 mm 30° angled upward, bayonet 15 cm St
5234	HMI-SI-5200	Rongeurs Caspar detachable Jaw width 3 mm 30° angled upward, bayonet 18 cm St
5235	HMI-SI-5201	Rongeurs Caspar detachable Jaw width 3 mm 30° angled upward, bayonet 15 cm SB
5236	HMI-SI-5202	Rongeurs Caspar detachable Jaw width 3 mm 30° angled upward, bayonet 18 cm SB
5237	HMI-SI-5203	Rongeurs Caspar detachable Jaw width 4 mm 30° angled upward, bayonet 15 cm St
5238	HMI-SI-5204	Rongeurs Caspar detachable Jaw width 4 mm 30° angled upward, bayonet 18 cm St
5239	HMI-SI-5205	Rongeurs Caspar detachable Jaw width 4 mm 30° angled upward, bayonet 15 cm SB
5240	HMI-SI-5206	Rongeurs Caspar detachable Jaw width 4 mm 30° angled upward, bayonet 18 cm SB
5241	HMI-SI-5207	Rongeurs Caspar detachable Jaw width 5 mm 30° angled upward, bayonet 15 cm St
5242	HMI-SI-5208	Rongeurs Caspar detachable Jaw width 5 mm 30° angled upward, bayonet 18 cm St
5243	HMI-SI-5209	Rongeurs Caspar detachable Jaw width 5 mm 30° angled upward, bayonet 15 cm SB
5244	HMI-SI-5210	Rongeurs Caspar detachable Jaw width 5 mm 30° angled upward, bayonet 18 cm SB
5245	HMI-SI-5211	Rongeurs Caspar detachable Jaw width 4 mm 50° angled upward 18 cm St
5246	HMI-SI-5212	Rongeurs Caspar detachable Jaw width 4 mm 50° angled upward 30 cm St
5247	HMI-SI-5213	Rongeurs Caspar detachable Jaw width 4 mm 50° angled downward 18 cm St







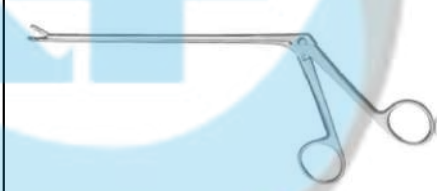







5248	HMI-SI-5214	Rongeurs Caspar detachable Jaw width 4 mm 50° angled downward 30 cm St
5249	HMI-SI-5215	Rongeurs Caspar detachable Jaw width 4 mm 50° angled upward 18 cm SB
5250	HMI-SI-5216	Rongeurs Caspar detachable Jaw width 4 mm 50° angled upward 30 cm SB
5251	HMI-SI-5217	Rongeurs Caspar detachable Jaw width 4 mm 50° angled downward 18 cm SB
5252	HMI-SI-5218	Rongeurs Caspar detachable Jaw width 4 mm 50° angled downward 30 cm SB
5253	HMI-SI-5219	Rongeurs Wagner detachable, strong model Jaw width 3 mm straight 20 cm St
5254	HMI-SI-5220	Rongeurs Wagner detachable, strong model Jaw width 3 mm straight 30 cm St
5255	HMI-SI-5221	Rongeurs Wagner detachable, strong model Jaw width 3 mm straight 20 cm SB
5256	HMI-SI-5221(a)	Rongeurs Wagner detachable, strong model Jaw width 3 mm straight 30 cm SB
5257	HMI-SI-5222	Rongeurs Wagner detachable, strong model Jaw width 4 mm straight 20 cm St
5258	HMI-SI-5223	Rongeurs Wagner detachable, strong model Jaw width 4 mm straight 30 cm St
5259	HMI-SI-5224	Rongeurs Wagner detachable, strong model Jaw width 4 mm straight 20 cm SB
5260	HMI-SI-5225	Rongeurs Wagner detachable, strong model Jaw width 4 mm straight 30 cm SB









5261	HMI-SI-5226	Rongeurs Wagner detachable, strong model Jaw width 4 mm 30° angled upward 20 cm St
5262	HMI-SI-5227	Rongeurs Wagner detachable, strong model Jaw width 4 mm 30° angled upward 30 cm St
5263	HMI-SI-5228	Rongeurs Wagner detachable, strong model Jaw width 4 mm 30° angled upward 20 cm SB
5264	HMI-SI-5229	Rongeurs Wagner detachable, strong model Jaw width 4 mm 30° angled upward 30 cm SB
5265	HMI-SI-5230	Rongeurs Wagner detachable, strong model Jaw width 4 mm 30° angled downward 20 cm St
5266	HMI-SI-5231	Rongeurs Wagner detachable, strong model Jaw width 4 mm 30° angled downward 30 cm St
5267	HMI-SI-5232	Rongeurs Wagner detachable, strong model Jaw width 4 mm 30° angled downward 20 cm SB
5268	HMI-SI-5233	Rongeurs Wagner detachable, strong model Jaw width 4 mm 30° angled downward 30 cm SB
5269	HMI-SI-5234	Rongeurs Wagner detachable, strong model Jaw width 5 mm straight 20 cm St
5270	HMI-SI-5235	Rongeurs Wagner detachable, strong model Jaw width 5 mm straight 30 cm St
5271	HMI-SI-5236	Rongeurs Wagner detachable, strong model Jaw width 5 mm straight 20 cm SB
5272	HMI-SI-5237	Rongeurs Wagner detachable, strong model Jaw width 5 mm straight 30 cm SB



5273	HMI-SI-5238	Rongeurs Richter detachable Jaw width 1,0 mm straight 18 cm St	
5274	HMI-SI-5239	Rongeurs Richter detachable Jaw width 1,0 mm 30° angled upward 18 cm St	
5275	HMI-SI-5240	Rongeurs Richter detachable Jaw width 1,0 mm straight 18 cm SB	
5276	HMI-SI-5241	Rongeurs Richter detachable Jaw width 1,0 mm 30° angled upward 18 cm SB	
5277	HMI-SI-5242	Rongeurs Richter detachable Jaw width 1,5 mm straight 18 cm St	
5278	HMI-SI-5243	Rongeurs Richter detachable Jaw width 1,5 mm 30° angled upward 18 cm St	
5279	HMI-SI-5244	Rongeurs Richter detachable Jaw width 1,5 mm straight 18 cm SB	
5280	HMI-SI-5245	Rongeurs Richter detachable Jaw width 1,5 mm 30° angled upward 18 cm SB	
5281	HMI-SI-5246	Laminectomy Rongeurs shaft length 180 mm 7,8 mm 25 cm / 9 3/4"	
5282	HMI-SI-5247	Laminectomy Rongeurs shaft length 185 mm 9,2 mm 27 cm / 10 3/4"	
5283	HMI-SI-5248	Laminectomy Rongeurs Yasargil 3,4 mm 25,5 cm / 10" Shaft length 180 mm	
5284	HMI-SI-5249	Laminectomy Rongeurs Yasargil 2,5 mm 25,5 cm / 10" Shaft length 200 mm	







5285	HMI-SI-5250	Pituitary specula Papavero-Caspar incl. handle 80 x 13 mm	
5286	HMI-SI-5251	Pituitary specula Papavero-Caspar incl. handle 90 x 13 mm	
5287	HMI-SI-5252	Pituitary specula Papavero-Caspar incl. handle 100 x 13 mm	
5288	HMI-SI-5253	Pituitary specula Cushing-Landolt 70 x 15 mm	
5289	HMI-SI-5254	Pituitary specula Cushing-Landolt 90 x 15 mm	
5290	HMI-SI-5255	Pituitary specula Cushing-Landolt 110 x 15 mm	
5291	HMI-SI-5255(a)	Tracheal Dilators Laborde 14 cm / 5 4/8"	
5292	HMI-SI-5255(b)	Tracheal Dilators Trousseau 14,5 cm / 5 6/8"	





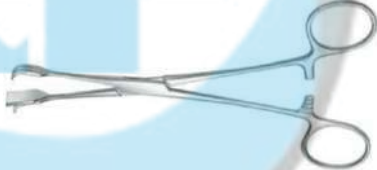

5293	HMI-SI-5256	Tracheal Hooks Iterson 17 cm / 6 6/8" sharp	
5294	HMI-SI-5257	Tracheal Hooks Iterson 17 cm / 6 6/8" blunt	
5295	HMI-SI-5258	Tracheal Hooks Rose 15,5 cm / 6 1/8"	
5296	HMI-SI-5259	Tracheal Hooks Luer 11 cm / 4 3/8"	
5297	HMI-SI-5260	Tracheal Hooks Lukens 17,5 cm / 6 7/8"	
5298	HMI-SI-5261	Tracheal Hooks Jackson 18 cm / 7 1/8"	
5299	HMI-SI-5262	Goitre Enucleator, Goitre Grasping Forceps Kocher 15,5 cm / 6 1/8"	
5300	HMI-SI-5263	Goitre Enucleator, Goitre Grasping Forceps Kocher 15,5 cm / 6 1/8" with eye	



5301	HMI-SI-5264	Goitre Enucleator, Goitre Grasping Forceps Lahey 8,1 mm 15,5 cm / 6 1/8"	
5302	HMI-SI-5265	Goitre Enucleator, Goitre Grasping Forceps Lahey 8,1 mm 20 cm / 7 7/8"	
5303	HMI-SI-5266	Milium Knife, Lupus Instruments Vidal 13 cm / 5 1/8"	
5304	HMI-SI-5267	Milium Knife, Lupus Instruments Fox 14 cm / 5 4/8" 3,0 mm	
5305	HMI-SI-5268	Milium Knife, Lupus Instruments Fox 14 cm / 5 4/8" 3,8 mm	
5306	HMI-SI-5269	Milium Knife, Lupus Instruments Fox 14 cm / 5 4/8" 5,0 mm	
5307	HMI-SI-5270	Milium Knife, Lupus Instruments Fox 14 cm / 5 4/8" 6,0 mm	
5308	HMI-SI-5271	Milium Knife, Lupus Instruments Wol° 14 cm / 5 4/8" 5,0 mm	

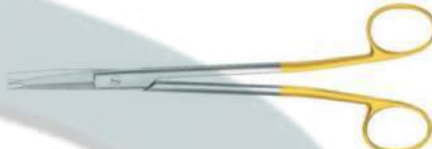

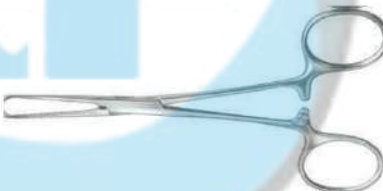
5309	HMI-SI-5272	Milium Knife, Lupus Instruments Wol° 14 cm / 5 4/8" 5,5 mm	
5310	HMI-SI-5273	Milium Knife, Lupus Instruments Wol° 14 cm / 5 4/8" 6,0 mm	
5311	HMI-SI-5274	Milium Knife, Lupus Instruments Wol° 14 cm / 5 4/8" 6,5 mm	
5312	HMI-SI-5275	Milium Knife, Lupus Instruments Wol° 14 cm / 5 4/8" 7,2 mm	
5313	HMI-SI-5276	Milium Knife, Lupus Instruments Wol° 14 cm / 5 4/8" 8,0 mm	
5314	HMI-SI-5277	Skin Hooklets, Dermal Punches Kilner 14,5 cm / 5 6/8" sharp	
5315	HMI-SI-5278	Skin Hooklets, Dermal Punches Gillies 18 cm / 7 1/8" small radius, sharp	
5316	HMI-SI-5279	Skin Hooklets, Dermal Punches Gillies 18 cm / 7 1/8" large radius, sharp	





5317	HMI-SI-5280	Skin Hooklets, Dermal Punches Kaye 13 cm / 5 1/8"	
5318	HMI-SI-5282	Skin Hooklets, Dermal Punches Kaye 13 cm / 5 1/8"	
5319	HMI-SI-5283	Skin Hooklets, Dermal Punches Keys 11 cm / 4 3/8" Ø 2,0 mm	
5320	HMI-SI-5284	Skin Hooklets, Dermal Punches Keys 11 cm / 4 3/8" Ø 3,0 mm	
5321	HMI-SI-5285	Skin Hooklets, Dermal Punches Keys 11 cm / 4 3/8" Ø 4,0 mm	
5322	HMI-SI-5286	Skin Hooklets, Dermal Punches Keys 11 cm / 4 3/8" Ø 5,0 mm	
5323	HMI-SI-5287	Skin Hooklets, Dermal Punches Keys 11 cm / 4 3/8" Ø 6,0 mm	
5324	HMI-SI-5288	Skin Hooklets, Dermal Punches Keys 11 cm / 4 3/8" Ø 7,0 mm	
5325	HMI-SI-5289	Skin Hooklets, Dermal Punches Keys 11 cm / 4 3/8" Ø 8,0 mm	
5326	HMI-SI-5290	Comedone Extractors Unna 14,5 cm / 5 6/8"	
5327	HMI-SI-5290(a)	Comedone Extractors Unna 14 cm / 5 4/8"	

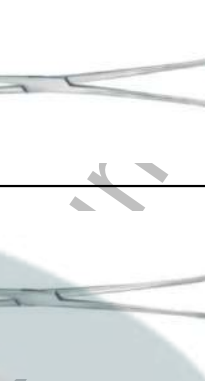
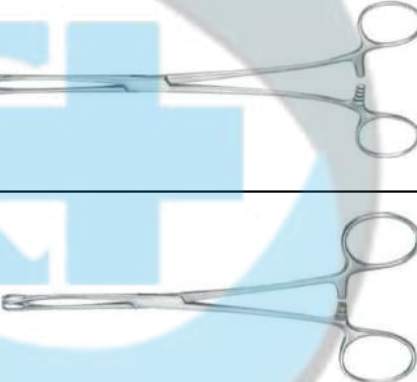

5328	HMI-SI-5291	Comedone Extractors Saalfeld 11 cm / 4 3/8"	
5329	HMI-SI-5292	Comedone Extractors Saalfeld 14,5 cm / 5 6/8"	
5330	HMI-SI-5293	Comedone Extractors Schamberg 9,5 cm / 3 6/8"	
5331	HMI-SI-5294	Comedone Extractors Katsch 16 cm / 6 2/8"	
5332	HMI-SI-5295	Comedone Extractors Unna-Vidal 11 cm / 4 3/8"	
5333	HMI-SI-5296	Face-lift Forceps, Face-lift Scissors d' Assumpção 16 cm / 6 2/8"	
5334	HMI-SI-5297	Face-lift Forceps, Face-lift Scissors TCGOLD Gregory 14,5 cm / 5 6/8" toothed	
5335	HMI-SI-5298	Face-lift Forceps, Face-lift Scissors TCGOLD Kaye one toothed cutting edge 15 cm / 6"	





5336	HMI-SI-5299	Face-lift Forceps, Face-lift Scissors TCGOLD Kaye one toothed cutting edge 18 cm / 7"	
5337	HMI-SI-5300	Face-lift Forceps, Face-lift Scissors TCGOLD Stella-S 18 cm / 7" one toothed cutting edge	
5338	HMI-SI-5301	Face-lift Scissors TCGOLD Gorney 17,5 cm / 6 68" one toothed cutting edge	
5339	HMI-SI-5302	Face-lift Scissors TCGOLD Freeman-Kaye 18 cm / 7" one toothed cutting edge	
5340	HMI-SI-5303	Face-lift Scissors TCGOLD Freeman 23 cm / 9" one toothed cutting edge	
5341	HMI-SI-5304	Intestinal and Tissue Grasping Forceps Allis-Baby 13 cm / 5 1/8"	
5342	HMI-SI-5304(a)	Intestinal and Tissue Grasping Forceps Allis 15,5 cm / 6 1/8"	
5343	HMI-SI-5305	Intestinal and Tissue Grasping Forceps Allis 15,5 cm / 6 1/8"	





5344	HMI-SI-5306	Intestinal and Tissue Grasping Forceps Allis 19 cm / 7 4/8"	
5345	HMI-SI-5307	Intestinal and Tissue Grasping Forceps Allis 25,5 cm / 10"	
5346	HMI-SI-5309	Intestinal and Tissue Grasping Forceps Allis Atrauma 15,5 cm / 6 1/8"	
5347	HMI-SI-5310	Intestinal and Tissue Grasping Forceps Allis Atrauma 20 cm / 7 7/8"	
5348	HMI-SI-5311	Intestinal and Tissue Grasping Forceps Allis Atrauma 24,5 cm / 9 5/8"	
5349	HMI-SI-5312	Intestinal and Tissue Grasping Forceps Allis Atrauma 30 cm / 11 6/8"	
5350	HMI-SI-5313	Intestinal and Tissue Grasping Forceps Allis-Adair 16 cm / 6 2/8"	
5351	HMI-SI-5314	Intestinal and Tissue Grasping Forceps Boys-Allis 15,5 cm / 6"	









5352	HMI-SI-5315	Intestinal and Tissue Grasping Forceps Judd-Allis 15,5 cm / 6 1/8"	
5353	HMI-SI-5316	Intestinal and Tissue Grasping Forceps Judd-Allis 19 cm / 7 4/8"	
5354	HMI-SI-5317	Intestinal and Tissue Grasping Forceps Thoms-Allis 20,5 cm / 8 1/8"	
5355	HMI-SI-5318	Intestinal and Tissue Grasping Forceps Allis 20 cm / 7 7/8"	
5356	HMI-SI-5319	Intestinal and Tissue Grasping Forceps Lockwood 20 cm / 7 7/8"	
5357	HMI-SI-5320	Intestinal and Tissue Grasping Forceps Williams 16,5 cm / 6 4/8"	
5358	HMI-SI-5321	Intestinal and Tissue Grasping Forceps TCGOLD Babcock 16,5 cm / 6 4/8"	
5359	HMI-SI-5322	Intestinal and Tissue Grasping Forceps TCGOLD Babcock 21 cm / 8 2/8"	





5360	HMI-SI-5323	Intestinal and Tissue Grasping Forceps Babcock 15,5 cm / 6"	
5361	HMI-SI-5324	Intestinal and Tissue Grasping Forceps Babcock 17,5 cm / 7"	
5362	HMI-SI-5325	Intestinal and Tissue Grasping Forceps Babcock 21 cm / 8 2/8"	
5363	HMI-SI-5326	Intestinal and Tissue Grasping Forceps Atrauma Babcock 20,5 cm / 8 1/8"	
5364	HMI-SI-5327	Intestinal and Tissue Grasping Forceps Atrauma Babcock 21 cm / 8 2/8"	
5365	HMI-SI-5328	Intestinal and Tissue Grasping Forceps TCGOLD Duval 20,5 cm / 8"	
5366	HMI-SI-5329	Intestinal and Tissue Grasping Forceps Duval 18 cm / 7 1/8"	
5367	HMI-SI-5330	Intestinal and Tissue Grasping Forceps Duval 20,5 cm / 8 1/8"	



5368	HMI-SI-5331	Intestinal and Tissue Grasping Forceps Duval 20,5 cm / 8"	
5369	HMI-SI-5332	Intestinal and Tissue Grasping Forceps Duval 23 cm / 9"	
5370	HMI-SI-5333	Intestinal and Tissue Grasping Forceps Doyen 21,5 cm / 8 4/8"	
5371	HMI-SI-5334	Intestinal and Tissue Grasping Forceps Doyen 21 cm / 8 2/8"	
5372	HMI-SI-5335	Intestinal and Tissue Grasping Forceps Doyen 23,5 cm / 9 2/8"	
5373	HMI-SI-5336	Intestinal and Tissue Grasping Forceps Doyen 23 cm / 9"	
5374	HMI-SI-5337	Intestinal Clamps Doyen-Baby 18 cm / 7 1/8"	
5375	HMI-SI-5338	Intestinal Clamps Doyen-Baby 17,5 cm / 6 7/8"	





5376	HMI-SI-5339	Intestinal Clamps Mayo-Robson 21,5 cm / 8 4/8"		
5377	HMI-SI-5340	Intestinal Clamps Mayo-Robson 23,5 cm / 9 2/8"		
5378	HMI-SI-5341	Intestinal Clamps Mayo-Robson 25,5 cm / 10"		
5379	HMI-SI-5342	Intestinal Clamps Kocher 22,5 cm / 8 7/8"		
5380	HMI-SI-5343	Intestinal Clamps Kocher 25 cm / 9 7/8"		
5381	HMI-SI-5344	Intestinal Clamps Kocher 28 cm / 11"		
5382	HMI-SI-5345	Intestinal Clamps Kocher 22 cm / 8 5/8"		
5383	HMI-SI-5346	Intestinal Clamps Kocher 24,5 cm / 9 5/8"		
				







5384	HMI-SI-5347	Intestinal Clamps Kocher 27,5 cm / 10 6/8"	
5385	HMI-SI-5348	Intestinal Clamps Allen 16 cm / 6 2/8"	
5386	HMI-SI-5349	Intestinal and Pylorus Clamps Payr-Baby 15 cm / 5 7/8" with pin	
5387	HMI-SI-5350	Intestinal and Pylorus Clamps Payr 21 cm / 8 2/8" with pin	
5388	HMI-SI-5351	Intestinal and Pylorus Clamps Payr 29 cm / 11 3/8" with pin	
5389	HMI-SI-5352	Intestinal and Pylorus Clamps Payr 34 cm / 13 3/8" with pin	
5390	HMI-SI-5353	Intestinal Anastomosis Clamps De Martel-Wolfson Set consisting of 3 pieces of one length: - 2 x lock, short - 1 x lock, long working length 65 mm	
5391	HMI-SI-5354	Intestinal Anastomosis Clamps De Martel-Wolfson Set consisting of 3 pieces of one length: - 2 x lock, short - 1 x lock, long working length 80 mm	





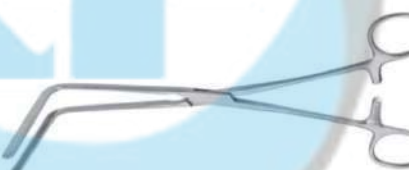

5392	HMI-SI-5355	Intestinal Anastomosis Clamps De Martel-Wolfson Set consisting of 3 pieces of one length: - 2 x lock, short - 1 x lock, long working length 110 mm	
5393	HMI-SI-5356	Intestinal Anastomosis Clamps De Martel-Wolfson 27 cm / 10 5/8" Closing Forceps	
5394	HMI-SI-5357	Intestinal Anastomosis Clamps De Martel-Wolfson 9,5 cm / 3 6/8" Clamp Holder	
5395	HMI-SI-5358	Intestinal Anastomosis Clamps De Martel-Wolfson 23 cm / 9" Clamp Holder	
5396	HMI-SI-5359	Intestinal Anastomosis Clamps Benson 15,5 cm / 6 1/8" Pylorus Spreader	
5397	HMI-SI-5360	Intestinal Anastomosis Clamps Stone-Watt 8,5 cm / 3 3/8"	
5398	HMI-SI-5361	Intestinal Anastomosis Clamps Stone-Watt 11 cm / 4 3/8"	
5399	HMI-SI-5363	Intestinal Anastomosis Clamps Stone-Watt Locking Device	







5400	HMI-SI-5364	Intestinal Anastomosis Clamps Stone-Watt 16 cm / 6 2/8" Closing Forceps	
5401	HMI-SI-5365	Stomach and Intestinal Anastomosis Twin Clamps Lane 30 cm / 11 6/8"	
5402	HMI-SI-5366	Stomach and Intestinal Anastomosis Twin Clamps Lane 30 cm / 11 6/8"	
5403	HMI-SI-5367	Organ Grasping Forceps Atrauma Scheibe 18 cm / 7 1/8" narrow	
5404	HMI-SI-5368	Organ Grasping Forceps Atrauma Scheibe 20,5 cm / 8 1/8" medium	
5405	HMI-SI-5369	Organ Grasping Forceps Atrauma Scheibe 23 cm / 9" wide	
5406	HMI-SI-5370	Intestinal Clamps Atrauma Doyen-Baby 14 cm / 5 4/8"	
5407	HMI-SI-5371	Intestinal Clamps Atrauma Doyen-Baby 17 cm / 6 6/8"	

5408	HMI-SI-5372	Intestinal Clamps Atrauma Doyen-Baby 18,5 cm / 7 2/8"		
5409	HMI-SI-5373	Intestinal Clamps Atrauma Doyen-Baby 21,5 cm / 8 4/8"		
5410	HMI-SI-5374	Intestinal Clamps Atrauma Doyen-Baby 23,5 cm / 9 2/8"		
5411	HMI-SI-5375	Intestinal Clamps Atrauma Doyen-Baby 13,5 cm / 5 2/8"		
5412	HMI-SI-5376	Intestinal Clamps Atrauma Doyen-Baby 17 cm / 6 6/8"		
5413	HMI-SI-5377	Intestinal Clamps Atrauma Doyen-Baby 18 cm / 7"		
5414	HMI-SI-5378	Intestinal Clamps Atrauma Doyen-Baby 21 cm / 8 2/8"		
5415	HMI-SI-5379	Intestinal Clamps Atrauma Mayo-Robson 26 cm / 10 2/8"		

5416	HMI-SI-5380	Intestinal Clamps Atrauma Mayo-Robson 25 cm / 9 2/8"	
5417	HMI-SI-5381	Intestinal Clamps Atrauma Kocher 22,5 cm / 8 6/8"	
5418	HMI-SI-5382	Intestinal Clamps Atrauma Kocher 25 cm / 9 7/8"	
5419	HMI-SI-5383	Intestinal Clamps Atrauma Kocher 28 cm / 11"	
5420	HMI-SI-5384	Intestinal Clamps Atrauma Kocher 22 cm / 8 5/8"	
5421	HMI-SI-5385	Intestinal Clamps Atrauma Kocher 24,5 cm / 9 5/ 8"	
5422	HMI-SI-5385(a)	Intestinal Clamps Atrauma Kocher 27 cm / 10 5/ 8"	
5423	HMI-SI-5386	Intestinal Clamps Atrauma Scudder 33,5 cm / 13 2/8"	





5424	HMI-SI-5387	Intestinal Clamps Atrauma Scudder 32,5 cm / 12 6/8"	
5425	HMI-SI-5388	Intestinal Clamps Atrauma Brunner 27 cm / 10 6/8"	
5426	HMI-SI-5389	Sigmoid Anastomosis Forceps Atrauma Hayes 27 cm / 10 5/8"s	
5427	HMI-SI-5389(a)	Sigmoid Anastomosis Forceps Atrauma Hayes 28 cm / 11"	
5428	HMI-SI-5390	Sigmoid Anastomosis Forceps Atrauma Veidenheimer 25 cm / 9 6/8"	
5429	HMI-SI-5391	Sigmoid Anastomosis Forceps Atrauma Fehland 24 cm / 9 4/8"	
5430	HMI-SI-5392	Sigmoid Anastomosis Forceps Atrauma Resano 28 cm / 11"	
5431	HMI-SI-5393	Rectal Specula, Rectal Spreaders Czerny 22,5 cm / 8 7/8"	



5432	HMI-SI-5394	Rectal Specula, Rectal Spreaders Sims 15,5 cm / 6 1/8"	
5433	HMI-SI-5395	Rectal Specula, Rectal Spreaders Sims 15,5 cm / 6 1/8"	
5434	HMI-SI-5396	Rectal Specula, Rectal Spreaders Pratt 20 cm / 7 7/8"	
5435	HMI-SI-5397	Rectal Specula, Rectal Spreaders Ives-Fansler Rectal Spreaders working length 80 mm	
5436	HMI-SI-5398	Rectal Spreaders Alan-Parks 14 cm / 5 4/8" without F.O. light carrier	
5437	HMI-SI-5399	Rectal Spreaders Alan-Parks 14 cm / 5 4/8" without F.O. light carrier Pair of lateral blades, long, useful length 95 mm	
5438	HMI-SI-5400	Rectal Spreaders Alan-Parks 14 cm / 5 4/8" without F.O. light carrier Wing nut	
5439	HMI-SI-5401	Rectal Spreaders Alan-Parks 14 cm / 5 4/8" without F.O. light carrier Valva central, longitud útil 95 mm	
5440	HMI-SI-5402	Rectal Spreaders Alan-Parks 14 cm / 5 4/8" without F.O. light carrier Pair of lateral blades, short, useful length 75 mm	
5441	HMI-SI-5403	Sphincteroscopes, Hemorrhoidal Ligator Kelly Ø 21 mm working length 50 mm	



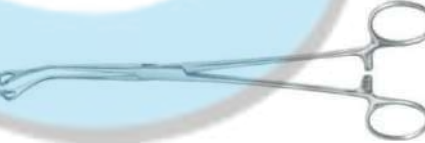





5442	HMI-SI-5404	Sphincteroscopes, Hemorrhoidal Ligator Kelly Ø 27 mm working length 50 mm	
5443	HMI-SI-5405	Sphincteroscopes, Hemorrhoidal Ligator Loading Cone	
5444	HMI-SI-5406	Sphincteroscopes, Hemorrhoidal Ligator Rudd 27,5 cm / 10 7/8" complete with loading cone	
5445	HMI-SI-5406(a)	Sphincteroscopes, Hemorrhoidal Ligator Rudd Rubber Rings package of 100 pieces	
5446	HMI-SI-5407	Hemorrhoidal Ligator, Rectal Biopsy Forceps McGinvey 19,5 cm / 7 5/8"	
5447	HMI-SI-5408	Hemorrhoidal Ligator, Rectal Biopsy Forceps Atrauma 38 cm / 15" Jaw width 15 mm	
5448	HMI-SI-5409	Kidney Stone Forceps Randall 23 cm / 9 "	
5449	HMI-SI-5410	Kidney Stone Forceps Randall 21 cm / 8 2/8"	



5450	HMI-SI-5411	Kidney Stone Forceps Randall 19 cm / 7 4/8"
5451	HMI-SI-5412	Kidney Stone Forceps Randall 18,5 cm / 7 2/8"
5452	HMI-SI-5413	Kidney Stone Forceps Heiming for children 16 cm / 6 2/8"
5453	HMI-SI-5414	Kidney Stone Forceps Heiming for children 17 cm / 6 6/8"
5454	HMI-SI-5415	Gall Duct Dilators Bakes 32 cm / 12 5/8" malleable shaft Ø 1,0 mm
5455	HMI-SI-5416	Gall Duct Dilators Bakes 32 cm / 12 5/8" malleable shaft Ø 2,0 mm
5456	HMI-SI-5417	Gall Duct Dilators Bakes 32 cm / 12 5/8" malleable shaft Ø 3,0 mm
5457	HMI-SI-5418	Gall Duct Dilators Bakes 32 cm / 12 5/8" malleable shaft Ø 4,0 mm
5458	HMI-SI-5419	Gall Duct Dilators Bakes 32 cm / 12 5/8" malleable shaft Ø 5,0 mm
5459	HMI-SI-5420	Gall Duct Dilators Bakes 32 cm / 12 5/8" malleable shaft Ø 6,0 mm
5460	HMI-SI-5421	Gall Duct Dilators Bakes 32 cm / 12 5/8" malleable shaft Ø 7,0 mm
5461	HMI-SI-5422	Gall Duct Dilators Bakes 32 cm / 12 5/8" malleable shaft Ø 8,0 mm



5462	HMI-SI-5423	Gall Duct Dilators Bakes 32 cm / 12 5/8" malleable shaft Ø 9,0 mm	
5463	HMI-SI-5424	Gall Duct Dilators Bakes 32 cm / 12 5/8" malleable shaft Ø 10,0 mm	
5464	HMI-SI-5425	Gall Duct Dilators Bakes 32 cm / 12 5/8" malleable shaft Ø 11,0 mm	
5465	HMI-SI-5426	Gall Duct Dilators Bakes 32 cm / 12 5/8" malleable shaft Ø 12,0 mm	
5466	HMI-SI-5427	Gall Duct Dilators Bakes 32 cm / 12 5/8" malleable shaft Ø 13,0 mm	
5467	HMI-SI-5428	Gall Duct Dilators Blake 21 cm / 8 2/8"	
5468	HMI-SI-5429	Gall Duct Dilators Blake 20,5 cm / 8 1/8"	
5469	HMI-SI-5430	Gall Duct Dilators Mayo-Blake 21 cm / 8 2/8"	
5470	HMI-SI-5431	Gall Duct Dilators Mayo-Blake 21 cm / 8 2/8"	
5471	HMI-SI-5432	Gall Duct Dilators Mixter 22 cm / 8 5/8"	

5472	HMI-SI-5433	Gall Duct Dilators Desjardins 23 cm / 9"	
5473	HMI-SI-5434	Gall Duct Dilators Desjardins 23 cm / 9"	
5474	HMI-SI-5435	Gall Duct Dilators Desjardins 22,5 cm / 8 7/8"	
5475	HMI-SI-5436	Gall Stone Scoops Luer-Körte 32 cm / 12 5/8" malleable shaft, blunt 2,7 mm	
5476	HMI-SI-5437	Gall Stone Scoops Luer-Körte 32 cm / 12 5/8" malleable shaft, blunt 3,4 mm	
5477	HMI-SI-5438	Gall Stone Scoops Luer-Körte 32 cm / 12 5/8" malleable shaft, blunt 4,3 mm	
5478	HMI-SI-5439	Gall Stone Scoops Luer-Körte 32 cm / 12 5/8" malleable shaft, blunt 5,5 mm	
5479	HMI-SI-5440	Gall Stone Scoops Luer-Körte 32 cm / 12 5/8" malleable shaft, blunt 6,6 mm	
5480	HMI-SI-5441	Gall Stone Scoops Luer-Körte 32 cm / 12 5/8" malleable shaft, blunt 8 mm	
5481	HMI-SI-5442	Gall Stone Scoops Luer-Körte 32 cm / 12 5/8" malleable shaft, blunt 11 mm	
5482	HMI-SI-5443	Gall Stone Scoops Luer-Körte 32 cm / 12 5/8" malleable shaft, blunt 15 mm	
5483	HMI-SI-5444	Prostatic Retractors Young 22 cm / 8 5/8" 12,5 mm	

5484	HMI-SI-5445	Prostatic Retractors Young 22 cm / 8 5/8" 24 mm	
5485	HMI-SI-5446	Prostatic Retractors Young 23 cm / 9" 41 mm	
5486	HMI-SI-5447	Capsule Forceps Atrauma Millin 24,5 cm / 9 5/8"	
5487	HMI-SI-5448	Capsule Forceps Atrauma Millin 22,5 cm / 8 7/8"	
5488	HMI-SI-5449	Capsule Forceps Atrauma Millin 24,5 cm / 9 5/8"	
5489	HMI-SI-5450	Capsule Forceps, Ligature Carrying Forceps Millin 22 cm / 8 5/8"	
5490	HMI-SI-5451	Capsule Forceps, Ligature Carrying Forceps Millin 24 cm / 9 4/8"	
5491	HMI-SI-5452	Bladder Neck Spreader, Bladder Retractors Millin 28 cm / 11"	







5492	HMI-SI-5453	Bladder Neck Spreader, Bladder Retractors Judd-Masson 120 mm	
5493	HMI-SI-5454	Bladder Retractors Millin complete, with 2 pairs of lateral blades 57 x 25 mm and 80 x 25 mm, and 1 central blade 120 x 45 mm	
5494	HMI-SI-5455	Bladder Retractors Lateral Blades 57 x 25 mm	
5495	HMI-SI-5456	Bladder Retractors Lateral Blades 80 x 25 mm	
5496	HMI-SI-5457	Bladder Retractors Central Blade 120 x 45 mm	
5497	HMI-SI-5458	Urethral Sounds Van Buren complete set, 8 - 36 Charrière 27 cm / 10 5/8"	
5498	HMI-SI-5459	Urethral Sounds Van Buren 27 cm / 10 5/8" 10 Charrière	
5499	HMI-SI-5460	Urethral Sounds Van Buren 27 cm / 10 5/8" 12 Charrière	
5500	HMI-SI-5461	Urethral Sounds Van Buren 27 cm / 10 5/8" 14 Charrière	
5501	HMI-SI-5462	Urethral Sounds Van Buren 27 cm / 10 5/8" 16 Charrière	
5502	HMI-SI-5463	Urethral Sounds Van Buren 27 cm / 10 5/8" 18 Charrière	





5503	HMI-SI-5464	Urethral Sounds Van Buren 27 cm / 10 5/8" 20 Charrière
5504	HMI-SI-5465	Urethral Sounds Van Buren 27 cm / 10 5/8" 22 Charrière
5505	HMI-SI-5466	Urethral Sounds Van Buren 27 cm / 10 5/8" 24 Charrière
5506	HMI-SI-5467	Urethral Sounds Van Buren 27 cm / 10 5/8" 26 Charrière
5507	HMI-SI-5468	Urethral Sounds Van Buren 27 cm / 10 5/8" 28 Charrière
5508	HMI-SI-5469	Urethral Sounds Van Buren 27 cm / 10 5/8" 30 Charrière
5509	HMI-SI-5470	Urethral Sounds Van Buren 27 cm / 10 5/8" 32 Charrière
5510	HMI-SI-5471	Urethral Sounds Van Buren 27 cm / 10 5/8" 34 Charrière
5511	HMI-SI-5472	Urethral Sounds Van Buren 27 cm / 10 5/8" 36 Charrière
5512	HMI-SI-5473	Urethral Sounds Guyon 26,5 cm / 10 3/8" Charrière 10
5513	HMI-SI-5474	Urethral Sounds Guyon 26,5 cm / 10 3/8" Charrière 11
5514	HMI-SI-5475	Urethral Sounds Guyon 26,5 cm / 10 3/8" Charrière 12
5515	HMI-SI-5476	Urethral Sounds Guyon 26,5 cm / 10 3/8" Charrière 13
5516	HMI-SI-5477	Urethral Sounds Guyon 26,5 cm / 10 3/8" Charrière 14
5517	HMI-SI-5478	Urethral Sounds Guyon 26,5 cm / 10 3/8" Charrière 15
5518	HMI-SI-5479	Urethral Sounds Guyon 26,5 cm / 10 3/8" Charrière 16







5519	HMI-SI-5480	Urethral Sounds Guyon 26,5 cm / 10 3/8" Charrière 17
5520	HMI-SI-5481	Urethral Sounds Guyon 26,5 cm / 10 3/8" Charrière 18
5521	HMI-SI-5482	Urethral Sounds Guyon 26,5 cm / 10 3/8" Charrière 19
5522	HMI-SI-5483	Urethral Sounds Guyon 26,5 cm / 10 3/8" Charrière 20
5523	HMI-SI-5484	Urethral Sounds Guyon 26,5 cm / 10 3/8" Charrière 21
5524	HMI-SI-5485	Urethral Sounds Guyon 26,5 cm / 10 3/8" Charrière 22
5525	HMI-SI-5486	Urethral Sounds Guyon 26,5 cm / 10 3/8" Charrière 23
5526	HMI-SI-5487	Urethral Sounds Guyon 26,5 cm / 10 3/8" Charrière 24
5527	HMI-SI-5488	Urethral Sounds Guyon 26,5 cm / 10 3/8" Charrière 25
5528	HMI-SI-5489	Urethral Sounds Guyon 26,5 cm / 10 3/8" Charrière 26
5529	HMI-SI-5490	Urethral Sounds Guyon 26,5 cm / 10 3/8" Charrière 27
5530	HMI-SI-5491	Urethral Sounds Guyon 26,5 cm / 10 3/8" Charrière 28
5531	HMI-SI-5492	Urethral Sounds Guyon 26,5 cm / 10 3/8" Charrière 29
5532	HMI-SI-5493	Urethral Sounds Guyon 26,5 cm / 10 3/8" Charrière 30
5533	HMI-SI-5494	Catheters 15 cm / 5 7/8" Metal Catheters, female Charrière 13

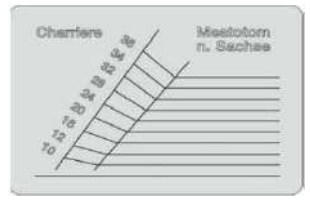







5534	HMI-SI-5495	Catheters 15 cm / 5 7/8" Metal Catheters, female Charrière 15	
5535	HMI-SI-5496	Urethrotome Otis complete in wooden case, with dilator, 2 knives and 3 tips	
5536	HMI-SI-5497	Urethrotome 3 tips only	
5537	HMI-SI-5498	Urethrotome Otis Spare Blade	
5538	HMI-SI-5499	Urethrography- and Circumcision Instruments Knutson Urethrography Instrument	
5539	HMI-SI-5500	Urethrography- and Circumcision Instruments Knutson-Koch Cone, only	
5540	HMI-SI-5501	Urethrography- and Circumcision Instruments Circumcision Instrument Ø 8 mm	
5541	HMI-SI-5502	Urethrography- and Circumcision Instruments Circumcision Instrument Ø 11 mm	
5542	HMI-SI-5503	Urethrography- and Circumcision Instruments Circumcision Instrument Ø 13 mm	

5543	HMI-SI-5504	Urethrography- and Circumcision Instruments Circumcision Instrument Ø 16 mm	
5544	HMI-SI-5505	Urethrography- and Circumcision Instruments Circumcision Instrument Ø 21 mm	
5545	HMI-SI-5506	Urethrography- and Circumcision Instruments Circumcision Instrument Ø 26 mm	
5546	HMI-SI-5507	Urethrography- and Circumcision Instruments Circumcision Instrument Ø 32 mm	
5547	HMI-SI-5508	Urethrography- and Circumcision Instruments Mogen 7,5 cm / 3 " Circumcision Instrument	
5548	HMI-SI-5509	Foreign Body Forceps Mathieu shaft length 200 mm	
5549	HMI-SI-5510	Foreign Body Forceps Mathieu shaft length 300 mm	
5550	HMI-SI-5511	Foreign Body Forceps Sachse shaft length 120 mm Meatotome	
5551	HMI-SI-5512	Foreign Body Forceps Sachse Gauge	





5552	HMI-SI-5513	Penis Clamps Stockmann 8 cm / 3 1/8"		
5553	HMI-SI-5514	Penis Clamps Strauss 11 cm / 4 3/8"		
5554	HMI-SI-5515	Penis Clamps Strauss 1 pair of flexible tubes only		
5555	HMI-SI-5516	Vaginal Specula Cusco 75 x 32 mm		
5556	HMI-SI-5517	Vaginal Specula Cusco 85 x 37 mm		
5557	HMI-SI-5518	Vaginal Specula Cusco 75 x 32 mm		
5558	HMI-SI-5519	Vaginal Specula Cusco 75 x 18 mm		
5559	HMI-SI-5520	Vaginal Specula Cusco 90 x 22 mm		



5560	HMI-SI-5521	Vaginal Specula Cusco 100 x 25 mm	
5561	HMI-SI-5522	Vaginal Specula Cusco 105 x 27 mm	
5562	HMI-SI-5523	Vaginal Specula Cusco 75 x 34 mm	
5563	HMI-SI-5524	Vaginal Specula Cusco 85 x 37 mm	
5564	HMI-SI-5525	Vaginal Specula Cusco 100 x 37 mm	
5565	HMI-SI-5526	Vaginal Specula Collin 85 x 30 mm	
5566	HMI-SI-5527	Vaginal Specula Collin 100 x 35 mm	
5567	HMI-SI-5528	Vaginal Specula Collin 110 x 40 mm	

5568	HMI-SI-5529	Vaginal Specula Trelat 85 x 33 mm	
5569	HMI-SI-5530	Vaginal Specula Trelat 95 x 35 mm	
5570	HMI-SI-5531	Vaginal Specula Trelat 115 x 43 mm	
5571	HMI-SI-5532	Vaginal Specula Pederson 75 x 13 mm	
5572	HMI-SI-5533	Vaginal Specula Pederson 100 x 24 mm	
5573	HMI-SI-5534	Vaginal Specula Pederson 120 x 26 mm	
5574	HMI-SI-5535	Vaginal Specula Grave 75 x 20 mm	
5575	HMI-SI-5536	Vaginal Specula Grave 95 x 35 mm	



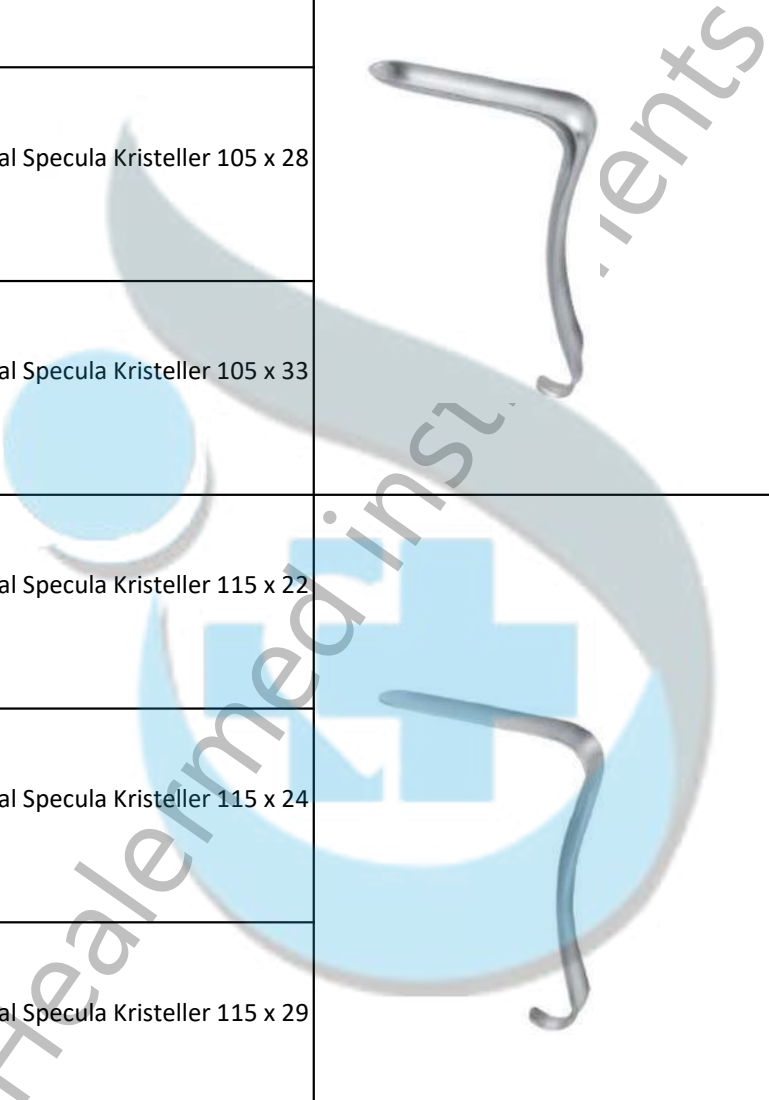

5576	HMI-SI-5537	Vaginal Specula Grave 115 x 35 mm	
5577	HMI-SI-5538	Vaginal Specula Semm 100 x 20-25 mm	
5578	HMI-SI-5539	Vaginal Specula Semm 100 x 27-35 mm	
5579	HMI-SI-5540	Vaginal Specula Guttman 90 x 35 mm	
5580	HMI-SI-5541	Vaginal Specula , Vaginal Retractors Sims 65 x 25 mm / 70 x 30 mm	
5581	HMI-SI-5542	Vaginal Specula , Vaginal Retractors Sims 70 x 30 mm/ 80 x 35 mm	
5582	HMI-SI-5543	Vaginal Specula , Vaginal Retractors Sims 85 x 35 mm / 90 x 40 mm	
5583	HMI-SI-5544	Vaginal Specula , Vaginal Retractors Jackson 75 x 38 mm	

5584	HMI-SI-5545	Vaginal Specula , Vaginal Retractors Jackson 90 x 38 mm	
5585	HMI-SI-5546	Vaginal Specula , Vaginal Retractors Jackson 100 x 38 mm	
5586	HMI-SI-5547	Vaginal Specula Kristeller 70 x 27 mm	
5587	HMI-SI-5548	Vaginal Specula Kristeller 80 x 30 mm	
5588	HMI-SI-5549	Vaginal Specula Kristeller 90 x 36 mm	
5589	HMI-SI-5550	Vaginal Specula Kristeller 75 x 23 mm	
5590	HMI-SI-5551	Vaginal Specula Kristeller 85 x 26 mm	
5591	HMI-SI-5552	Vaginal Specula Kristeller 100 x 32 mm	



5592	HMI-SI-5553	Vaginal Specula Kristeller	
5593	HMI-SI-5554	Vaginal Specula Kristeller	
5594	HMI-SI-5555	Vaginal Specula Kristeller	
5595	HMI-SI-5556	Vaginal Specula Kristeller 105 x 18 mm	
5596	HMI-SI-5557	Vaginal Specula Kristeller 105 x 21 mm	
5597	HMI-SI-5558	Vaginal Specula Kristeller 110 x 14 mm	
5598	HMI-SI-5559	Vaginal Specula Kristeller 110 x 17 mm	
5599	HMI-SI-5560	Vaginal Specula Kristeller	



5600	HMI-SI-5561	Vaginal Specula Kristeller	
5601	HMI-SI-5562	Vaginal Specula Kristeller 105 x 26 mm	
5602	HMI-SI-5563	Vaginal Specula Kristeller 105 x 28 mm	
5603	HMI-SI-5564	Vaginal Specula Kristeller 105 x 33 mm	
5604	HMI-SI-5565	Vaginal Specula Kristeller 115 x 22 mm	
5605	HMI-SI-5566	Vaginal Specula Kristeller 115 x 24 mm	
5606	HMI-SI-5567	Vaginal Specula Kristeller 115 x 29 mm	
5607	HMI-SI-5568	Vaginal Specula Kristeller	





5608	HMI-SI-5569	Vaginal Specula Kristeller	
5609	HMI-SI-5570	Vaginal Specula Kristeller	
5610	HMI-SI-5571	Vaginal Specula Kristeller 110 x 28 mm	
5611	HMI-SI-5572	Vaginal Specula Kristeller 110 x 30 mm	
5612	HMI-SI-5573	Vaginal Specula Kristeller 110 x 36 mm	
5613	HMI-SI-5574	Vaginal Specula Kristeller 115 x 23 mm	
5614	HMI-SI-5575	Vaginal Specula Kristeller 115 x 26 mm	
5615	HMI-SI-5576	Vaginal Specula Kristeller 115 x 32 mm	

5616	HMI-SI-5577	Vaginal Specula Kristeller	
5617	HMI-SI-5578	Vaginal Specula Kristeller	
5618	HMI-SI-5579	Vaginal Specula Kristeller	
5619	HMI-SI-5580	Vaginal Specula Kallmorgen 70 x 40 mm	
5620	HMI-SI-5581	Vaginal Specula Kallmorgen 90 x 40 mm	
5621	HMI-SI-5582	Vaginal Specula Kallmorgen 70 x 37 mm	
5622	HMI-SI-5583	Vaginal Specula Kallmorgen 90 x 37 mm	
5623	HMI-SI-5584	Vaginal Specula Kallmorgen	

5624	HMI-SI-5585	Vaginal Specula Kallmorgen	
5625	HMI-SI-5586	Vaginal Specula Doyen 58 x 35 mm	
5626	HMI-SI-5587	Vaginal Specula Doyen 88 x 35 mm	
5627	HMI-SI-5588	Vaginal Specula Doyen 118 x 35 mm	
5628	HMI-SI-5589	Vaginal Specula Doyen 60 x 47 mm	
5629	HMI-SI-5590	Vaginal Specula Doyen 95 x 47 mm	
5630	HMI-SI-5591	Vaginal Specula Doyen 120 x 47 mm	
5631	HMI-SI-5592	Vaginal Specula Doyen 165 x 47 mm	
5632	HMI-SI-5593	Vaginal Specula Doyen 55 x 60 mm	
5633	HMI-SI-5594	Vaginal Specula Doyen 85 x 60 mm	
5634	HMI-SI-5595	Vaginal Specula Doyen 115 x 60 mm	
5635	HMI-SI-5596	Vaginal Specula Scherbak Blatt, allein Valva vaginal, suelta 80 x 30 mm	
5636	HMI-SI-5597	Vaginal Specula Scherbak Blatt, allein Valva vaginal, suelta 85 x 35 mm	

5637	HMI-SI-5598	Vaginal Specula Scherbak Blatt, allein Valva vaginal, suelta 90 x 40 mm	
5638	HMI-SI-5599	Vaginal Specula Scherbak Blatt, allein Valva vaginal, suelta 58 x 40 - 60 mm	
5639	HMI-SI-5600	Vaginal Specula Scherbak Blatt, allein Valva vaginal, suelta 70 x 45 - 70 mm	
5640	HMI-SI-5601(a)	Vaginal Specula Scherbak complete set with handle, weight (400 g) and 5 blades	
5641	HMI-SI-5601	Vaginal Specula Scherbak 10,5 cm / 4 " / 400 g Weight for Vaginal Speculum	
5642	HMI-SI-5602	Vaginal Specula Scherbak 13 cm / 5 " / 800 g Weight for Vaginal Speculum	
5643	HMI-SI-5603	Vaginal Specula Scherbak 20 cm / 7 7/8" Handle for Vaginal Speculum	
5644	HMI-SI-5604	Vaginal Specula Auvard 23,5 cm / 9 2/8" complete, with detachable weight	

5645	HMI-SI-5605	Vaginal Specula Auvard Weight only 1 Kg	
5646	HMI-SI-5606	Vaginal Specula, Vaginal Retractors Weissbarth 21 cm / 8 2/8" complete, with detachable strainer	
5647	HMI-SI-5607	Vaginal Specula, Vaginal Retractors Breisky 100 x 20 mm 29,5 cm / 11 5/8"	
5648	HMI-SI-5608	Vaginal Specula, Vaginal Retractors Breisky 100 x 25 mm 29,5 cm / 11 5/8"	
5649	HMI-SI-5609	Vaginal Specula, Vaginal Retractors Breisky 100 x 30 mm 29,5 cm / 11 5/8"	
5650	HMI-SI-5610	Vaginal Specula, Vaginal Retractors Breisky 100 x 35 mm 29,5 cm / 11 5/8"	
5651	HMI-SI-5611	Vaginal Specula, Vaginal Retractors Breisky 100 x 40 mm 29,5 cm / 11 5/8"	
5652	HMI-SI-5612	Vaginal Specula, Vaginal Retractors Breisky 130 x 20 mm 32 cm / 12 5/8"	
5653	HMI-SI-5613	Vaginal Specula, Vaginal Retractors Breisky 130 x 25 mm 32 cm / 12 5/8"	
5654	HMI-SI-5614	Vaginal Specula, Vaginal Retractors Breisky 130 x 30 mm 32 cm / 12 5/8"	
5655	HMI-SI-5615	Vaginal Specula, Vaginal Retractors Breisky 130 x 35 mm 32 cm / 12 5/8"	
5656	HMI-SI-5616	Vaginal Specula, Vaginal Retractors Breisky 130 x 40 mm 32 cm / 12 5/8"	
5657	HMI-SI-5617	Vaginal Specula, Vaginal Retractors Breisky 160 x 40 mm 35 cm / 13 6/8"	



5658	HMI-SI-5618	Vaginal Specula, Vaginal Retractors Doyen 25 cm / 9 7/8"	
5659	HMI-SI-5620	Endocervical Specula, Uterine Dilators Kogan 24,5 cm / 9 5/8"	
5660	HMI-SI-5621	Endocervical Specula, Uterine Dilators Kogan 24,5 cm / 9 5/8"	
5661	HMI-SI-5622	Endocervical Specula, Uterine Dilators Kogan 34 cm / 13 3/8"	
5662	HMI-SI-5623	Uterine Dilators Hegar 18,5 cm / 7 2/8" 1,0 mm Ø	
5663	HMI-SI-5624	Uterine Dilators Hegar 18,5 cm / 7 2/8" 2,0 mm Ø	
5664	HMI-SI-5625	Uterine Dilators Hegar 18,5 cm / 7 2/8" 3,0 mm Ø	
5665	HMI-SI-5626	Uterine Dilators Hegar 18,5 cm / 7 2/8" 4,0 mm Ø	
5666	HMI-SI-5627	Uterine Dilators Hegar 18,5 cm / 7 2/8" 5,0 mm Ø	
5667	HMI-SI-5628	Uterine Dilators Hegar 18,5 cm / 7 2/8" 6,0 mm Ø	
5668	HMI-SI-5629	Uterine Dilators Hegar 18,5 cm / 7 2/8" 7,0 mm Ø	
5669	HMI-SI-5630	Uterine Dilators Hegar 18,5 cm / 7 2/8" 8,0 mm Ø	
5670	HMI-SI-5631	Uterine Dilators Hegar 18,5 cm / 7 2/8" 9,0 mm Ø	
5671	HMI-SI-5632	Uterine Dilators Hegar 18,5 cm / 7 2/8" 10,0 mm Ø	
5672	HMI-SI-5633	Uterine Dilators Hegar 18,5 cm / 7 2/8" 11,0 mm Ø	
5673	HMI-SI-5634	Uterine Dilators Hegar 18,5 cm / 7 2/8" 12,0 mm Ø	
5674	HMI-SI-5635	Uterine Dilators Hegar 18,5 cm / 7 2/8" 13,0 mm Ø	







5675	HMI-SI-5636	Uterine Dilators Hegar 18,5 cm / 7 2/8" 14,0 mm Ø
5676	HMI-SI-5637	Uterine Dilators Hegar 18,5 cm / 7 2/8" 15,0 mm Ø
5677	HMI-SI-5638	Uterine Dilators Hegar 18,5 cm / 7 2/8" 16,0 mm Ø
5678	HMI-SI-5639	Uterine Dilators Hegar 18,5 cm / 7 2/8" 17,0 mm Ø
5679	HMI-SI-5640	Uterine Dilators Hegar 18,5 cm / 7 2/8" 18,0 mm Ø
5680	HMI-SI-5641	Uterine Dilators Hegar 18,5 cm / 7 2/8" 19,0 mm Ø
5681	HMI-SI-5642	Uterine Dilators Hegar 18,5 cm / 7 2/8" 20,0 mm Ø
5682	HMI-SI-5643	Uterine Dilators Hegar 18,5 cm / 7 2/8" 21,0 mm Ø
5683	HMI-SI-5644	Uterine Dilators Hegar 18,5 cm / 7 2/8" 22,0 mm Ø
5684	HMI-SI-5645	Uterine Dilators Hegar 18,5 cm / 7 2/8" 23,0 mm Ø
5685	HMI-SI-5646	Uterine Dilators Hegar 18,5 cm / 7 2/8" 24,0 mm Ø
5686	HMI-SI-5647	Uterine Dilators Hegar 18,5 cm / 7 2/8" 25,0 mm Ø
5687	HMI-SI-5648	Uterine Dilators Hegar 18,5 cm / 7 2/8" 26,0 mm Ø
5688	HMI-SI-5649	Uterine Dilators Hegar 18,5 cm / 7 2/8" 1,5 mm Ø
5689	HMI-SI-5650	Uterine Dilators Hegar 18,5 cm / 7 2/8" 2,5 mm Ø
5690	HMI-SI-5651	Uterine Dilators Hegar 18,5 cm / 7 2/8" 3,5 mm Ø
5691	HMI-SI-5652	Uterine Dilators Hegar 18,5 cm / 7 2/8" 4,5 mm Ø
5692	HMI-SI-5653	Uterine Dilators Hegar 18,5 cm / 7 2/8" 5,5 mm Ø
5693	HMI-SI-5654	Uterine Dilators Hegar 18,5 cm / 7 2/8" 6,5 mm Ø
5694	HMI-SI-5655	Uterine Dilators Hegar 18,5 cm / 7 2/8" 7,5 mm Ø
5695	HMI-SI-5656	Uterine Dilators Hegar 18,5 cm / 7 2/8" 8,5 mm Ø
5696	HMI-SI-5657	Uterine Dilators Hegar 18,5 cm / 7 2/8" 9,5 mm Ø
5697	HMI-SI-5658	Uterine Dilators Hegar 18,5 cm / 7 2/8" 10,5 mm Ø
5698	HMI-SI-5659	Uterine Dilators Hegar 18,5 cm / 7 2/8" 11,5 mm Ø
5699	HMI-SI-5660	Uterine Dilators Hegar 18,5 cm / 7 2/8" 12,5 mm Ø















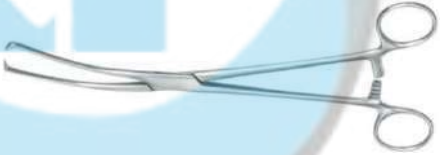

5700	HMI-SI-5661	Uterine Dilators Hegar 18,5 cm / 7 2/8" 13,5 mm Ø
5701	HMI-SI-5662	Uterine Dilators Hegar 18,5 cm / 7 2/8" 14,5 mm Ø
5702	HMI-SI-5663	Uterine Dilators Hegar 18,5 cm / 7 2/8" 15,5 mm Ø
5703	HMI-SI-5664	Uterine Dilators Hegar 18,5 cm / 7 2/8" 16,5 mm Ø
5704	HMI-SI-5665	Uterine Dilators Hegar 18,5 cm / 7 2/8" 17,5 mm Ø
5705	HMI-SI-5666	Uterine Dilators set of 14 pieces (full sizes) from 4,0 to 17,0 mm without case
5706	HMI-SI-5667	Uterine Dilators set of 26 pieces (full sizes) from 1,0 to 26,0 mm without case
5707	HMI-SI-5668	Uterine Dilators metal case only, for Ø 4-17 mm
5708	HMI-SI-5669	Uterine Dilators Hegar 20 cm / 7 7/8" 1,0 / 2,0 mm Ø
5709	HMI-SI-5670	Uterine Dilators Hegar 20 cm / 7 7/8" 3,0 / 4,0 mm Ø
5710	HMI-SI-5671	Uterine Dilators Hegar 20 cm / 7 7/8" 5,0 / 6,0 mm Ø
5711	HMI-SI-5672	Uterine Dilators Hegar 20 cm / 7 7/8" 7,0 / 8,0 mm Ø
5712	HMI-SI-5673	Uterine Dilators Hegar 20 cm / 7 7/8" 9,0 / 10,0 mm Ø
5713	HMI-SI-5674	Uterine Dilators Hegar 20 cm / 7 7/8" 11,0 / 12,0 mm Ø
5714	HMI-SI-5675	Uterine Dilators Hegar 20 cm / 7 7/8" 13,0 / 14,0 mm Ø
5715	HMI-SI-5676	Uterine Dilators Hegar 20 cm / 7 7/8" 15,0 / 16,0 mm Ø
5716	HMI-SI-5677	Uterine Dilators Hegar 20 cm / 7 7/8" 17,0 / 18,0 mm Ø
5717	HMI-SI-5678	Uterine Dilators Hegar 20 cm / 7 7/8" 19,0 / 20,0 mm Ø
5718	HMI-SI-5679	Uterine Dilators Hegar 20 cm / 7 7/8" 21,0 / 22,0 mm Ø



















5719	HMI-SI-5680	Uterine Dilators Hegar 20 cm / 7 7/8" 23,0 / 24,0 mm Ø	
5720	HMI-SI-5681	Uterine Dilators Hegar 20 cm / 7 7/8" 25,0 / 26,0 mm Ø	
5721	HMI-SI-5682	Uterine Dilators Hegar set of 8 pieces from 3,0 / 4,0 to 17,0 / 18,0 mm without case	
5722	HMI-SI-5683	Uterine Dilators Hegar set of 8 pieces from 3,0 / 4,0 to 17,0 / 18,0 mm in boilable canvas roll	
5723	HMI-SI-5684	Uterine Dilators Hank 26,5 cm / 10 3/8" American scale 9 / 10 4,5 / 5,0 mm Ø	
5724	HMI-SI-5685	Uterine Dilators Hank 26,5 cm / 10 3/8" American scale 11 / 12 5,5 / 6,0 mm Ø	
5725	HMI-SI-5686	Uterine Dilators Hank 26,5 cm / 10 3/8" American scale 13 / 14 6,5 / 7,0 mm Ø	
5726	HMI-SI-5687	Uterine Dilators Hank 26,5 cm / 10 3/8" American scale 15 / 16 7,5 / 8,0 mm Ø	
5727	HMI-SI-5688	Uterine Dilators Hank 26,5 cm / 10 3/8" American scale 17 / 18 8,5 / 9,0 mm Ø	









5728	HMI-SI-5689	Uterine Dilators Hank 26,5 cm / 10 3/8" American scale 19 / 20 9,5 / 10,0 mm Ø	
5729	HMI-SI-5690	Uterine Dilators Hank set of 6 piezas in boilable canvas roll	
5730	HMI-SI-5691	Uterine Sounds, Uterine Depressor Sims 33 cm / 13" rigid Ø 4 mm	
5731	HMI-SI-5692	Uterine Sounds, Uterine Depressor Sims 33 cm / 13" malleable Ø 4 mm	
5732	HMI-SI-5693	Uterine Sounds, Uterine Depressor Valleix 25,5 cm / 10"	
5733	HMI-SI-5694	Uterine Sounds, Uterine Depressor Braun 27 cm / 10 5/8"	
5734	HMI-SI-5695	Uterine Tenaculum Forceps, Amniotome Schröder 25,5 cm / 10"	
5735	HMI-SI-5696	Uterine Tenaculum Forceps, Amniotome Braun 26 cm / 10 2/8"	

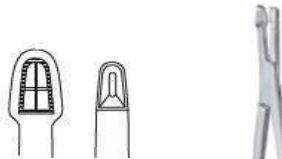



5736	HMI-SI-5697	Uterine Tenaculum Forceps, Amniotome Duplay 28 cm / 11 "	
5737	HMI-SI-5698	Uterine Tenaculum Forceps, Amniotome Beacham 26 cm / 10 2/8"	
5738	HMI-SI-5699	Uterine Tenaculum Forceps Skene 24 cm / 9 4/8"	
5739	HMI-SI-5700	Uterine Tenaculum Forceps Schröder 25 cm / 9 7/8"	
5740	HMI-SI-5701	Uterine Tenaculum Forceps Schröder 25 cm / 9 7/8"	
5741	HMI-SI-5702	Uterine Tenaculum Forceps Teale 23 cm / 9 "	
5742	HMI-SI-5703	Uterine Tenaculum Forceps Iowa 26 cm / 10 2/8"	
5743	HMI-SI-5704	Uterine Tenaculum Forceps Museux 24 cm / 9 4/8" 7 mm	



5744	HMI-SI-5705	Uterine Tenaculum Forceps Museux 24 cm / 9 4/8" 9 mm	
5745	HMI-SI-5706	Uterine Tenaculum Forceps Museux 24 cm / 9 4/8" 10 mm	
5746	HMI-SI-5707	Uterine Tenaculum Forceps Jacobs 21 cm / 8 2/8"	
5747	HMI-SI-5708	Uterine Tenaculum Forceps 26,5 cm / 10 3/8"	
5748	HMI-SI-5709	Uterine Tenaculum Forceps Braun 16 cm / 6 2/8"	
5749	HMI-SI-5710	Uterine Tenaculum Forceps Czerny 21 cm / 8 2/8"	
5750	HMI-SI-5711	Uterine Tenaculum Forceps Kelly 31,5 cm / 12 3/8"	
5751	HMI-SI-5712	Uterine Tenaculum Forceps Noto 27 cm / 10 5/8"	

5752	HMI-SI-5713	Uterine Tenaculum Forceps Heywood-Smith 26 cm / 10 2/8	
5753	HMI-SI-5714	Myoma Screws, Myoma Knife Doyen 17 cm / 6 6/8" Ø 15 mm	
5754	HMI-SI-5715	Myoma Screws, Myoma Knife Doyen 15 cm / 5 7/8" Ø 25 mm	
5755	HMI-SI-5716	Myoma Screws, Myoma Knife Segond 28 cm / 11 "	
5756	HMI-SI-5717	Uterine Seizing Forceps Dartigues 27 cm / 10 5/8"	
5757	HMI-SI-5718	Uterine Seizing Forceps Somer 22,5 cm / 8 7/8"	
5758	HMI-SI-5719	Uterine Seizing Forceps Collin 26 cm / 10 2/8"	
5759	HMI-SI-5720	Fistula Hooks Ayre 23,5 cm / 9 2/8" Conization Knife	

5760	HMI-SI-5721	Fistula Hooks Emmett 23 cm / 9 "	
5761	HMI-SI-5722	Fistula Hooks Simon 21,5 cm / 8 4/8"	
5762	HMI-SI-5723	Fistula Hooks Simon 21,5 cm / 8 4/8"	
5763	HMI-SI-5724	Suction Curettes Novak 24,5 cm / 9 5/8" with Luer-Lock connection	
5764	HMI-SI-5725	Suction Curettes Kevorkian 30 cm / 11 6/8"	
5765	HMI-SI-5726	Suction Curettes Mod. München 27 cm / 10 5/8"	
5766	HMI-SI-5727	Uterine Biopsy Forceps Gellhorn 24 cm / 9 4/8"	
5767	HMI-SI-5728	Uterine Biopsy Forceps Faure 21 cm / 8 2/8"	

5768	HMI-SI-5729	Uterine Biopsy Forceps Schubert 21,5 cm / 8 4/8"	
5769	HMI-SI-5730	Uterine Biopsy Forceps Schubert 28 cm / 11 "	
5770	HMI-SI-5731	Uterine Biopsy Forceps Thoms-Gaylor 21 cm / 8 2/8"	
5771	HMI-SI-5732	Uterine Biopsy Forceps Thoms-Gaylor 24 cm / 9 4/8"	
5772	HMI-SI-5733	Uterine Biopsy Forceps Schubert 24 cm / 9 4/8"	
5773	HMI-SI-5734	Uterine Biopsy Forceps Van Doren 27 cm / 10 5/8"	
5774	HMI-SI-5735	Uterine Biopsy Forceps Van Doren 25,5 cm / 10 "	
5775	HMI-SI-5736	Uterine Biopsy Forceps Alexander retrograde cutting, jaws curved to left, suitable als in colposcopy shaft length 195 mm jaw 5,1 mm wide	

5776	HMI-SI-5737	Uterine Biopsy Forceps Kevorkian shaft length 250 mm jaw 3 mm wide	
5777	HMI-SI-5738	Uterine Biopsy Forceps Schumacher shaft length 225 mm jaw 5,4 mm wide	
5778	HMI-SI-5739	Uterine Biopsy Forceps, IUP Grasping Forceps Schumacher 25 cm / 9 6/8"	
5779	HMI-SI-5740	Uterine Biopsy Forceps, IUP Grasping Forceps Schumacher 25 cm / 9 6/8" Interchangeable tube 22 cm	
5780	HMI-SI-5741	Uterine Biopsy Forceps, IUP Grasping Forceps Schumacher 25 cm / 9 6/8" Handle	
5781	HMI-SI-5742	Uterine Biopsy Forceps, IUP Grasping Forceps Schumacher 25 cm / 9 6/8" Tip	
5782	HMI-SI-5743	Uterine Biopsy Forceps, IUP Grasping Forceps Schumacher 25 cm / 9 6/8"	
5783	HMI-SI-5744	Uterine Biopsy Forceps, IUP Grasping Forceps Schumacher 25 cm / 9 6/8" Interchangeable tube 32 cm	
5784	HMI-SI-5745	Uterine Biopsy Forceps, IUP Grasping Forceps Schumacher 25 cm / 9 6/8" Interchangeable tube 41 cm	
5785	HMI-SI-5746	Uterine Biopsy Forceps, IUP Grasping Forceps Schumacher 25 cm / 9 6/8"	
5786	HMI-SI-5747	Uterine Biopsy Forceps, IUP Grasping Forceps 27 cm / 10 5/8" Ø 3,0 mm shaft length 225 mm	

5787	HMI-SI-5748	Uterine Biopsy Forceps, IUP Grasping Forceps 32 cm / 12 5/8" Ø 3,0 mm shaft length 270 mm	
5788	HMI-SI-5749	Uterine Scoops, Uterine Curettes Simon sharp, rigid 23 cm / 9" 10 x 7 mm	
5789	HMI-SI-5749(a)	Uterine Scoops, Uterine Curettes Simon sharp, rigid 23,5 cm / 9 2/8" 12 x 8 mm	
5790	HMI-SI-5750	Uterine Scoops, Uterine Curettes Simon sharp, rigid 24 cm / 9 4/8" 13 x 10 mm	
5791	HMI-SI-5751	Uterine Scoops, Uterine Curettes Simon sharp, rigid 24 cm / 9 4/8" 16 x 12 mm	
5792	HMI-SI-5752	Uterine Scoops, Uterine Curettes Simon sharp, rigid 24 cm / 9 4/8" 18 x 13 mm	
5793	HMI-SI-5753	Uterine Scoops, Uterine Curettes Simon sharp, rigid 24 cm / 9 4/8" 20 x 15 mm	
5794	HMI-SI-5754	Uterine Scoops, Uterine Curettes Schröder 30 cm / 11 6/8" sharp, rigid 10 x 7 mm	
5795	HMI-SI-5754(a)	Uterine Scoops, Uterine Curettes Schröder 30 cm / 11 6/8" sharp, rigid 12 x 8 mm	
5796	HMI-SI-5755	Uterine Scoops, Uterine Curettes Schröder 30 cm / 11 6/8" sharp, rigid 13 x 10 mm	
5797	HMI-SI-5756	Uterine Scoops, Uterine Curettes Schröder 30 cm / 11 6/8" sharp, rigid 16 x 12 mm	
5798	HMI-SI-5757	Uterine Scoops, Uterine Curettes Schröder 30 cm / 11 6/8" sharp, rigid 18 x 13 mm	
5799	HMI-SI-5758	Uterine Scoops, Uterine Curettes Schröder 30 cm / 11 6/8" sharp, rigid 20 x 15 mm	
5800	HMI-SI-5759	Uterine Scoops, Uterine Curettes Blake 27,5 cm / 10 7/8"	
5801	HMI-SI-5760	Uterine Curettes Recamier width 5 mm sharp, rigid	

5802	HMI-SI-5761	Uterine Currettes Recamier width 6 mm sharp, rigid
5803	HMI-SI-5762	Uterine Currettes Recamier width 7 mm sharp, rigid
5804	HMI-SI-5763	Uterine Currettes Recamier width 8 mm sharp, rigid
5805	HMI-SI-5764	Uterine Currettes Recamier width 9 mm sharp, rigid
5806	HMI-SI-5765	Uterine Currettes Recamier width 11 mm sharp, rigid
5807	HMI-SI-5766	Uterine Currettes Recamier width 12 mm sharp, rigid
5808	HMI-SI-5767	Uterine Currettes Recamier width 14 mm sharp, rigid
5809	HMI-SI-5768	Uterine Currettes Recamier width 15 mm sharp, rigid
5810	HMI-SI-5769	Uterine Currettes Recamier width 16 mm sharp, rigid
5811	HMI-SI-5770	Uterine Currettes Recamier width 19 mm sharp, rigid
5812	HMI-SI-5771	Uterine Currettes Recamier width 20 mm sharp, rigid
5813	HMI-SI-5772	Uterine Currettes Recamier width 21 mm sharp, rigid
5814	HMI-SI-5773	Uterine Currettes Recamier width 23 mm sharp, rigid
5815	HMI-SI-5774	Uterine Currettes Recamier width 25 mm sharp, rigid
5816	HMI-SI-5775	Uterine Currettes Recamier width 30 mm sharp, rigid
5817	HMI-SI-5776	Uterine Currettes Recamier width 35 mm sharp, rigid
5818	HMI-SI-5777	Uterine Currettes Recamier width 40 mm sharp, rigid
5819	HMI-SI-5778	Uterine Currettes Recamier width 5 mm sharp, malleable
5820	HMI-SI-5779	Uterine Currettes Recamier width 6 mm sharp, malleable
5821	HMI-SI-5780	Uterine Currettes Recamier width 7 mm sharp, malleable
5822	HMI-SI-5781	Uterine Currettes Recamier width 8 mm sharp, malleable
5823	HMI-SI-5782	Uterine Currettes Recamier width 9 mm sharp, malleable
5824	HMI-SI-5783	Uterine Currettes Recamier width 11 mm sharp, malleable
5825	HMI-SI-5784	Uterine Currettes Recamier width 12 mm sharp, malleable



5826	HMI-SI-5785	Uterine Currettes Recamier width 14 mm sharp, malleable
5827	HMI-SI-5786	Uterine Currettes Recamier width 15 mm sharp, malleable
5828	HMI-SI-5787	Uterine Currettes Recamier width 16 mm sharp, malleable
5829	HMI-SI-5788	Uterine Currettes Recamier width 19 mm sharp, malleable
5830	HMI-SI-5789	Uterine Currettes Recamier width 20 mm sharp, malleable
5831	HMI-SI-5790	Uterine Currettes Recamier width 21 mm sharp, malleable
5832	HMI-SI-5791	Uterine Currettes Recamier width 23 mm sharp, malleable
5833	HMI-SI-5792	Uterine Currettes Recamier width 25 mm sharp, malleable
5834	HMI-SI-5793	Uterine Currettes Recamier width 30 mm sharp, malleable
5835	HMI-SI-5794	Uterine Currettes Recamier width 35 mm sharp, malleable
5836	HMI-SI-5795	Uterine Currettes Recamier width 40 mm sharp, malleable
5837	HMI-SI-5796	Uterine Currettes Recamier width 5 mm blunt, rigid
5838	HMI-SI-5797	Uterine Currettes Recamier width 6 mm blunt, rigid
5839	HMI-SI-5798	Uterine Currettes Recamier width 7 mm blunt, rigid
5840	HMI-SI-5799	Uterine Currettes Recamier width 8 mm blunt, rigid
5841	HMI-SI-5800	Uterine Currettes Recamier width 9 mm blunt, rigid
5842	HMI-SI-5801	Uterine Currettes Recamier width 11 mm blunt, rigid
5843	HMI-SI-5802	Uterine Currettes Recamier width 12 mm blunt, rigid
5844	HMI-SI-5803	Uterine Currettes Recamier width 14 mm blunt, rigid

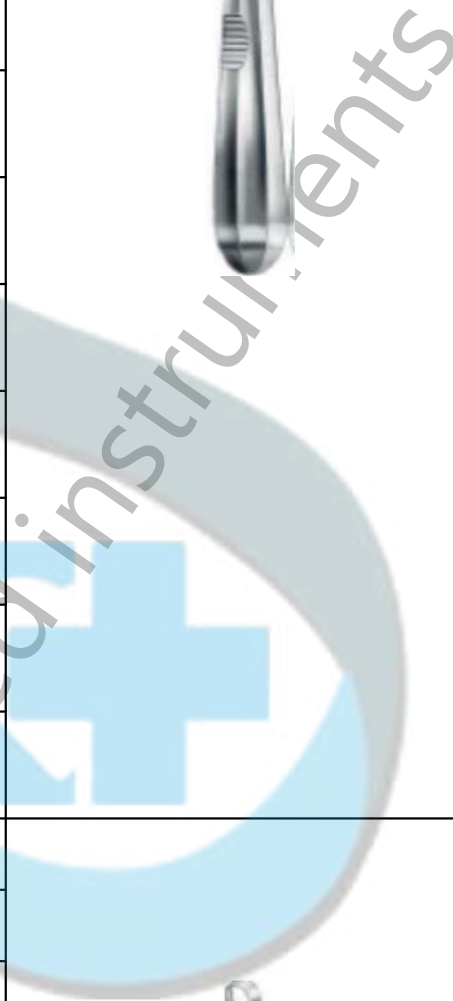









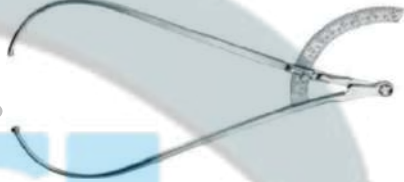

5845	HMI-SI-5804	Uterine Currettes Recamier width 15 mm blunt, rigid
5846	HMI-SI-5805	Uterine Currettes Recamier width 16 mm blunt, rigid
5847	HMI-SI-5806	Uterine Currettes Recamier width 19 mm blunt, rigid
5848	HMI-SI-5807	Uterine Currettes Recamier width 20 mm blunt, rigid
5849	HMI-SI-5808	Uterine Currettes Recamier width 21 mm blunt, rigid
5850	HMI-SI-5809	Uterine Currettes Recamier width 23 mm blunt, rigid
5851	HMI-SI-5810	Uterine Currettes Recamier width 25 mm blunt, rigid
5852	HMI-SI-5811	Uterine Currettes Recamier width 30 mm blunt, rigid
5853	HMI-SI-5812	Uterine Currettes Recamier width 35 mm blunt, rigid
5854	HMI-SI-5813	Uterine Currettes Recamier width 40 mm blunt, rigid
5855	HMI-SI-5814	Uterine Currettes Recamier width 5 mm blunt, malleable
5856	HMI-SI-5815	Uterine Currettes Recamier width 6 mm blunt, malleable
5857	HMI-SI-5816	Uterine Currettes Recamier width 7 mm blunt, malleable
5858	HMI-SI-5817	Uterine Currettes Recamier width 8 mm blunt, malleable
5859	HMI-SI-5818	Uterine Currettes Recamier width 9 mm blunt, malleable
5860	HMI-SI-5819	Uterine Currettes Recamier width 11 mm blunt, malleable
5861	HMI-SI-5820	Uterine Currettes Recamier width 12 mm blunt, malleable
5862	HMI-SI-5821	Uterine Currettes Recamier width 14 mm blunt, malleable
5863	HMI-SI-5822	Uterine Currettes Recamier width 15 mm blunt, malleable
5864	HMI-SI-5823	Uterine Currettes Recamier width 16 mm blunt, malleable
5865	HMI-SI-5824	Uterine Currettes Recamier width 19 mm blunt, malleable



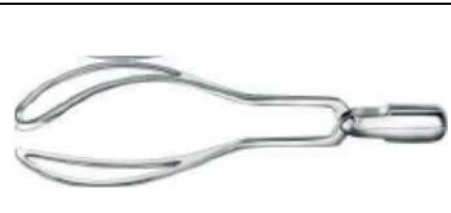

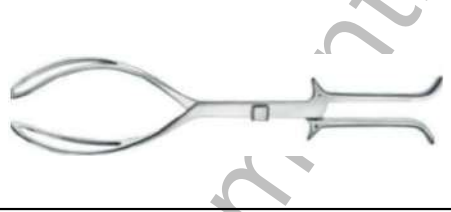

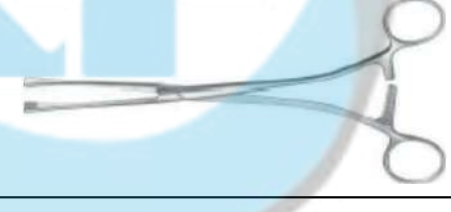





5866	HMI-SI-5825	Uterine Currettes Recamier width 20 mm blunt, malleable
5867	HMI-SI-5826	Uterine Currettes Recamier width 21 mm blunt, malleable
5868	HMI-SI-5827	Uterine Currettes Recamier width 23 mm blunt, malleable
5869	HMI-SI-5828	Uterine Currettes Recamier width 25 mm blunt, malleable
5870	HMI-SI-5829	Uterine Currettes Recamier width 30 mm blunt, malleable
5871	HMI-SI-5830	Uterine Currettes Recamier width 35 mm blunt, malleable
5872	HMI-SI-5831	Uterine Currettes Recamier width 40 mm blunt, malleable
5873	HMI-SI-5832	Uterine Currettes, Suction Currettes Greene 28 cm / 11 " 10 mm
5874	HMI-SI-5833	Uterine Currettes, Suction Currettes Greene 28 cm / 11 " 12 mm
5875	HMI-SI-5834	Uterine Currettes, Suction Currettes Greene 28 cm / 11 " 14 mm
5876	HMI-SI-5835	Uterine Currettes, Suction Currettes 29 cm / 11 3/8" Ø 3,0 mm
5877	HMI-SI-5836	Uterine Currettes, Suction Currettes 29 cm / 11 3/8" Ø 4,5 mm





5878	HMI-SI-5837	Uterine Currettes, Suction Currettes 29 cm / 11 3/8" Ø 6,0 mm	
5879	HMI-SI-5838	Uterine Currettes, Suction Currettes 29 cm / 11 3/8" Ø 8,0 mm	
5880	HMI-SI-5839	Uterine Currettes, Suction Currettes 29 cm / 11 3/8" Ø 10,0 mm	
5881	HMI-SI-5840	Uterine Currettes, Suction Currettes 29 cm / 11 3/8" Ø 12,0 mm	
5882	HMI-SI-5841	Uterine Currettes, Suction Currettes 29 cm / 11 3/8" Ø 14,0 mm	
5883	HMI-SI-5842	Uterine Currettes, Suction Currettes Coupling Piece 11 cm / 4 3/8"	
5884	HMI-SI-5843	Pelvimeter Martin 35 cm / 13 6/8"	
5885	HMI-SI-5844	Pelvimeter Nägele 36,5 cm / 14 3/8"	
5886	HMI-SI-5845	Pelvimeter Nägele 40,5 cm / 16 "	
5887	HMI-SI-5846	Pelvimeter Simpson 30,5 cm / 12"	

5888	HMI-SI-5847	Pelvimeter Wrigley 28 cm / 11"	
5889	HMI-SI-5848	Pelvimeter Simpson 36,5 cm / 14 2/8"	
5890	HMI-SI-5849	Obstetrical Forceps Kielland 41 cm / 16 1/8"	
5891	HMI-SI-5850	Obstetrical Forceps Kielland-Luikart 40 cm / 15 6/8"	
5892	HMI-SI-5851	Obstetrical Forceps Piper 44,5 cm / 17 4/8"	
5893	HMI-SI-5852	Placenta and Ovum Forceps Green-Armytage 21 cm / 8 2/8" Uterine Clamp	
5894	HMI-SI-5853	Placenta and Ovum Forceps Sanger 17,5 mm 27,5 cm / 10 7/8"	
5895	HMI-SI-5854	Placenta and Ovum Forceps Sanger 17,5 mm 27,5 cm / 10 7/8"	

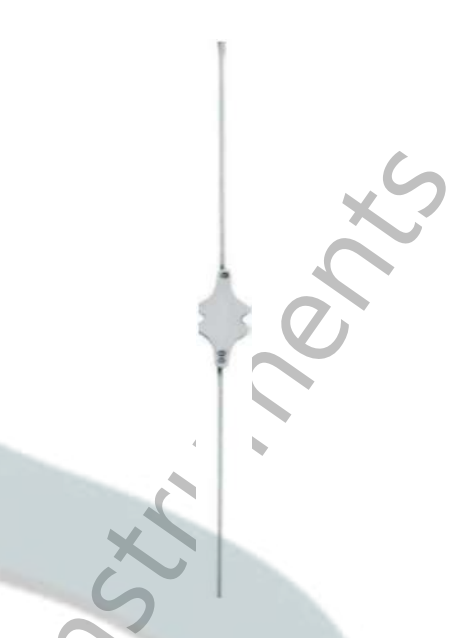

5896	HMI-SI-5855	Placenta and Ovum Forceps Winter 28 cm / 11" 9,5 mm	
5897	HMI-SI-5856	Placenta and Ovum Forceps Winter 28 cm / 11" 13,5 mm	
5898	HMI-SI-5857	Placenta and Ovum Forceps Winter 28 cm / 11" 9,5 mm	
5899	HMI-SI-5858	Placenta and Ovum Forceps Winter 28 cm / 11" 13,5 mm	
5900	HMI-SI-5859	Placenta and Ovum Forceps Sellheim 32 cm / 12 5/8" Obstetrical Lever	
5901	HMI-SI-5860	Placenta Scoops Cuzzi 30 cm / 11 6/8" blunt, backside serrated 17 mm	
5902	HMI-SI-5861	Placenta Scoops Cuzzi 30 cm / 11 6/8" blunt, backside serrated 20 mm	
5903	HMI-SI-5862	Placenta Scoops Cuzzi 30 cm / 11 6/8" blunt, backside serrated 23 mm	



5904	HMI-SI-5863	Placenta Scoops, Umbilical Cord Clamp Pestalozza 30,5 cm / 12 "	
5905	HMI-SI-5864	Placenta Scoops, Umbilical Cord Clamp Collin 8,5 cm / 3 3/8"	
5906	HMI-SI-5865	Trowel Knives 12 cm / 6 6/8"	
5907	HMI-SI-5866	Trowel Knives 16 cm / 6 2/8"	
5908	HMI-SI-5867	Callipers Castroviejo 8 cm / 3 1/8" effective range 0-15 mm	
5909	HMI-SI-5868	Callipers Castroviejo 8 cm / 3 1/8" effective range 0-20 mm	
5910	HMI-SI-5869	Callipers Castroviejo 8 cm / 3 1/8" effective range 0-20 mm	
5911	HMI-SI-5870	Callipers Castroviejo-Epker 9 cm / 3 4/8" effective range 0-40 mm	

5912	HMI-SI-5871	Callipers Castroviejo-Epker 18 cm / 7 1/8" effective range 0-40 mm		
5913	HMI-SI-5872	Probes Bowman 13 cm / 5 1/8" 0 / 0		
5914	HMI-SI-5873	Probes Bowman 13 cm / 5 1/8" 1 / 1		
5915	HMI-SI-5874	Probes Bowman 13 cm / 5 1/8" 2 / 2		
5916	HMI-SI-5875	Probes Bowman 13 cm / 5 1/8" 3 / 3		
5917	HMI-SI-5876	Probes Bowman 13 cm / 5 1/8" 4 / 4		
5918	HMI-SI-5877	Probes Bowman 13 cm / 5 1/8" 5 / 5		
5919	HMI-SI-5878	Probes Bowman 13 cm / 5 1/8" 6 / 6		
5920	HMI-SI-5879	Probes Bowman 13 cm / 5 1/8" 7 / 7		
5921	HMI-SI-5880	Probes Bowman 13 cm / 5 1/8" 8 / 8		
5922	HMI-SI-5881	Probes Bowman 13 cm / 5 1/8" 0000 / 000		
5923	HMI-SI-5882	Probes Bowman 13 cm / 5 1/8" 000 / 00		
5924	HMI-SI-5883	Probes Bowman 13 cm / 5 1/8" 0 / 1		
5925	HMI-SI-5884	Probes Bowman 13 cm / 5 1/8" 1 / 2		
5926	HMI-SI-5885	Probes Bowman 13 cm / 5 1/8" 2 / 3		
5927	HMI-SI-5886	Probes Bowman 13 cm / 5 1/8" 3 / 4		
5928	HMI-SI-5887	Probes Bowman 13 cm / 5 1/8" 4 / 5		
5929	HMI-SI-5888	Probes Bowman 13 cm / 5 1/8" 5 / 6		
5930	HMI-SI-5889	Probes Bowman 13 cm / 5 1/8" 6 / 7		
5931	HMI-SI-5890	Probes Bowman 13 cm / 5 1/8" 7 / 8		
5932	HMI-SI-5891	Probes Bowman 13 cm / 5 1/8" 00 / 0		
5933	HMI-SI-5892	Probes Bowman 13 cm / 5 1/8" 0 / 1		
5934	HMI-SI-5893	Probes Bowman 13 cm / 5 1/8" 1 / 2		

5935	HMI-SI-5894	Probes Bowman 13 cm / 5 1/8" 2 / 3
5936	HMI-SI-5895	Probes Bowman 13 cm / 5 1/8" 3 / 4
5937	HMI-SI-5896	Probes Bowman 13 cm / 5 1/8" 4 / 5
5938	HMI-SI-5897	Probes Bowman 13 cm / 5 1/8" 5 / 6
5939	HMI-SI-5898	Probes Bowman 13 cm / 5 1/8" 6 / 7
5940	HMI-SI-5899	Probes Bowman 13 cm / 5 1/8" 7 / 8
5941	HMI-SI-5900	Micro Ear Forceps straight, smooth 8 cm SB
5942	HMI-SI-5901	Micro Ear Forceps straight, serrated 8 cm SB
5943	HMI-SI-5902	Micro Ear Forceps bent upwards, serrated 8 cm SB
5944	HMI-SI-5903	Micro Ear Forceps right, serrated 8 cm SB
5945	HMI-SI-5904	Micro Ear Forceps left, serrated 8 cm SB
5946	HMI-SI-5905	Micro Ear Forceps straight, smooth 8 cm St



5947	HMI-SI-5906	Micro Ear Forceps straight, serrated 8 cm St		
5948	HMI-SI-5907	Micro Ear Forceps bent upwards, serrated 8 cm St		
5949	HMI-SI-5908	Micro Ear Forceps right, serrated 8 cm St		
5950	HMI-SI-5909	Micro Ear Forceps left, serrated 8 cm St		
5951	HMI-SI-5910	Micro Ear Forceps Mini-McGee straight, smooth 8 cm SB		
5952	HMI-SI-5911	Micro Ear Forceps Mini-McGee straight, serrated 8 cm SB		
5953	HMI-SI-5912	Micro Ear Forceps Mini-McGee straight, smooth 8 cm St		
5954	HMI-SI-5913	Micro Ear Forceps Mini-McGee straight, serrated 8 cm St		

5955	HMI-SI-5914	Micro Ear Forceps straight, smooth 8 cm SB	
5956	HMI-SI-5915	Micro Ear Forceps straight, smooth 8 cm St	
5957	HMI-SI-5916	Micro Ear Forceps straight, serrated 8 cm SB	
5958	HMI-SI-5917	Micro Ear Forceps bent upwards, serrated 8 cm SB	
5959	HMI-SI-5918	Micro Ear Forceps right, serrated 8 cm SB	
5960	HMI-SI-5919	Micro Ear Forceps left, serrated 8 cm SB	
5961	HMI-SI-5920	Micro Ear Forceps straight, serrated 8 cm St	
5962	HMI-SI-5921	Micro Ear Forceps bent upwards, serrated 8 cm St	

5963	HMI-SI-5922	Micro Ear Forceps right, serrated 8 cm St
5964	HMI-SI-5923	Micro Ear Forceps left, serrated 8 cm St
5965	HMI-SI-5924	Micro Ear Forceps cup straight 8 cm SB
5966	HMI-SI-5925	Micro Ear Forceps cup bent upwards 8 cm SB
5967	HMI-SI-5926	Micro Ear Forceps cup right 8 cm SB
5968	HMI-SI-5927	Micro Ear Forceps cup left 8 cm SB
5969	HMI-SI-5928	Micro Ear Forceps cup straight 8 cm St
5970	HMI-SI-5929	Micro Ear Forceps cup bent upwards 8 cm St



5971	HMI-SI-5930	Micro Ear Forceps cup right 8 cm St
5972	HMI-SI-5931	Micro Ear Forceps cup left 8 cm St
5973	HMI-SI-5932	Micro Ear Forceps Mini-McGee cup straight 8 cm SB
5974	HMI-SI-5933	Micro Ear Forceps Mini-McGee cup bent upwards 8 cm SB
5975	HMI-SI-5934	Micro Ear Forceps Mini-McGee cup right 8 cm SB
5976	HMI-SI-5935	Micro Ear Forceps Mini-McGee cup left 8 cm SB
5977	HMI-SI-5936	Micro Ear Forceps Mini-McGee cup straight 8 cm St
5978	HMI-SI-5937	Micro Ear Forceps Mini-McGee cup bent upwards 8 cm St



hents



5979	HMI-SI-5938	Micro Ear Forceps Mini-McGee cup right 8 cm St
5980	HMI-SI-5939	Micro Ear Forceps Mini-McGee cup left 8 cm St
5981	HMI-SI-5940	Micro Ear Scissors Bellucci very delicate straight 8 cm SB
5982	HMI-SI-5941	Micro Ear Scissors Bellucci very delicate bent upwards 8 cm SB
5983	HMI-SI-5942	Micro Ear Scissors Bellucci very delicate right 8 cm SB
5984	HMI-SI-5943	Micro Ear Scissors Bellucci very delicate left 8 cm SB
5985	HMI-SI-5944	Micro Ear Scissors Bellucci very delicate straight 8 cm St
5986	HMI-SI-5945	Micro Ear Scissors Bellucci very delicate bent upwards 8 cm St







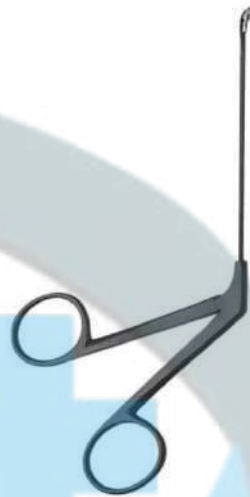

ments







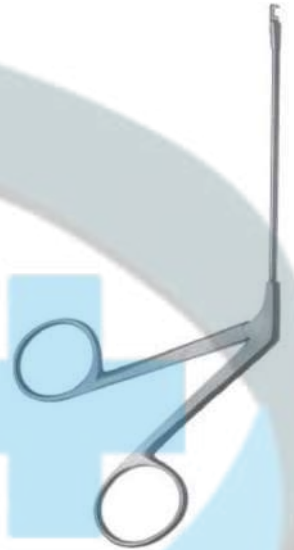

5987	HMI-SI-5946	Micro Ear Scissors Bellucci very delicate right 8 cm St
5988	HMI-SI-5947	Micro Ear Scissors Bellucci very delicate left 8 cm St
5989	HMI-SI-5948	Micro Ear Scissors Wullstein very delicate straight 8 cm SB
5990	HMI-SI-5949	Micro Ear Scissors Wullstein very delicate bent upwards 8 cm SB
5991	HMI-SI-5950	Micro Ear Scissors Wullstein very delicate right 8 cm SB
5992	HMI-SI-5951	Micro Ear Scissors Wullstein very delicate left 8 cm SB
5993	HMI-SI-5952	Micro Ear Scissors Wullstein very delicate straight 8 cm St
5994	HMI-SI-5953	Micro Ear Scissors Wullstein very delicate bent upwards 8 cm St



5995	HMI-SI-5954	Micro Ear Scissors Wullstein very delicate right 8 cm St	
5996	HMI-SI-5955	Micro Ear Scissors Wullstein very delicate left 8 cm St	
5997	HMI-SI-5955(a)	Micro Ear Forceps McGee Wire Bending Forceps angled downward 8 cm 0,8 x 3,5 mm SB	
5998	HMI-SI-5955(b)	Micro Ear Forceps McGee Wire Bending Forceps angled downward 8 cm 0,8 x 6,0 mm SB	
5999	HMI-SI-5956(a)	Micro Ear Forceps McGee Wire Bending Forceps angled downward 8 cm 0,8 x 3,5 mm St	
6000	HMI-SI-5956(b)	Micro Ear Forceps McGee Wire Bending Forceps angled downward 8 cm 0,8 x 6,0 mm St	
6001	HMI-SI-5957	Micro Ear Forceps House-Dieter Malleus Nipper up-cutting 9 cm SB	
6002	HMI-SI-5958	Micro Ear Forceps House-Dieter Malleus Nipper down-cutting 9 cm SB	

6003	HMI-SI-5959	Micro Ear Forceps House-Dieter Malleus Nipper right-cutting 9 cm SB	
6004	HMI-SI-5960	Micro Ear Forceps House-Dieter Malleus Nipper left-cutting 9 cm SB	
6005	HMI-SI-5961	Micro Ear Forceps House-Dieter Malleus Nipper up-cutting 9 cm St	
6006	HMI-SI-5962	Micro Ear Forceps House-Dieter Malleus Nipper down-cutting 9 cm St	
6007	HMI-SI-5963	Micro Ear Forceps House-Dieter Malleus Nipper right-cutting 9 cm St	
6008	HMI-SI-5964	Micro Ear Forceps House-Dieter Malleus Nipper left-cutting 9 cm St	
6009	HMI-SI-5965	Micro Ear Forceps Fuller Introducing Forceps, for te" on prosthesis SB	
6010	HMI-SI-5966	Micro Ear Forceps Fuller Introducing Forceps, for te" on prosthesis St	

6011	HMI-SI-5967	Micro Ear Knives Schuknecht 14,5 cm / 5 6/8" Sickle Knife	
6012	HMI-SI-5967(a)	Micro Ear Knives Wullstein 15,5 cm / 6 1/8" Sickle Knife	
6013	HMI-SI-5967(b)	Micro Ear Knives Tabb 15,5 cm / 6 1/8" Mucosa Knife	
6014	HMI-SI-5968	Micro Ear Knives Plester 15 cm / 5 7/8" Flap Knife	
6015	HMI-SI-5969	Micro Ear Knives Rosen 15 cm / 5 7/8" Ø 3,0 mm	
6016	HMI-SI-5970	Micro Ear Knives Rosen 15 cm / 5 7/8" Ø 2,8 mm	
6017	HMI-SI-5971	Micro Ear Knives Rosen 15 cm / 5 7/8" Ø 2,6 mm	
6018	HMI-SI-5972	Micro Ear Knives Rosen 15 cm / 5 7/8" Ø 2,0 mm	
6019	HMI-SI-5973	Micro Ear Knives Rosen 15 cm / 5 7/8" Ø 1,6 mm	
6020	HMI-SI-5974	Micro Ear Knives Rosen 15 cm / 5 7/8" Ø 1,4 mm	
6021	HMI-SI-5975	Micro Ear Knives Rosen 15 cm / 5 7/8" Ø 1,0 mm	
6022	HMI-SI-5976	Micro Ear Hooks, Micro Ear Needles Barbara 16 cm / 6 2/8"	
6023	HMI-SI-5977	Micro Ear Hooks, Micro Ear Needles Barbara 16 cm / 6 2/8"	
6024	HMI-SI-5978	Micro Ear Hooks, Micro Ear Needles Barbara 16 cm / 6 2/8"	
6025	HMI-SI-5979	Micro Ear Hooks, Micro Ear Needles Barbara 16 cm / 6 2/8"	

6026	HMI-SI-5980	Micro Ear Hooks, Micro Ear Needles Haken 16 cm / 6 2/8" 0,3 mm 25°
6027	HMI-SI-5981	Micro Ear Hooks, Micro Ear Needles Haken 16 cm / 6 2/8" 0,6 mm 25°
6028	HMI-SI-5982	Micro Ear Hooks, Micro Ear Needles Haken 16 cm / 6 2/8" 1,0 mm 25°
6029	HMI-SI-5983	Micro Ear Hooks, Micro Ear Needles Haken 16 cm / 6 2/8" 0,3 mm 45°
6030	HMI-SI-5984	Micro Ear Hooks, Micro Ear Needles Haken 16 cm / 6 2/8" 0,6 mm 45°
6031	HMI-SI-5985	Micro Ear Hooks, Micro Ear Needles Haken 16 cm / 6 2/8" 1,0 mm 45°
6032	HMI-SI-5986	Micro Ear Hooks, Micro Ear Needles Haken 16 cm / 6 2/8" 1,2 mm 45°
6033	HMI-SI-5987	Micro Ear Hooks, Micro Ear Needles Haken 16 cm / 6 2/8" 1,5 mm 45°
6034	HMI-SI-5988	Micro Ear Hooks, Micro Ear Needles Haken 16 cm / 6 2/8" 2,0 mm 45°
6035	HMI-SI-5989	Micro Ear Hooks, Micro Ear Needles Haken 16 cm / 6 2/8" 5,0 mm 45°
6036	HMI-SI-5990	Micro Ear Hooks, Micro Ear Needles Haken 16 cm / 6 2/8" 0,3 mm 90°
6037	HMI-SI-5991	Micro Ear Hooks, Micro Ear Needles Haken 16 cm / 6 2/8" 0,6 mm 90°
6038	HMI-SI-5992	Micro Ear Hooks, Micro Ear Needles Haken 16 cm / 6 2/8" 1,0 mm 90°
6039	HMI-SI-5993	Micro Ear Hooks, Micro Ear Needles Haken 16 cm / 6 2/8" 1,2 mm 90°
6040	HMI-SI-5994	Micro Ear Hooks, Micro Ear Needles Haken 16 cm / 6 2/8" 1,5 mm 90°
6041	HMI-SI-5995	Micro Ear Hooks, Micro Ear Needles Haken 16 cm / 6 2/8" 2,0 mm 90°

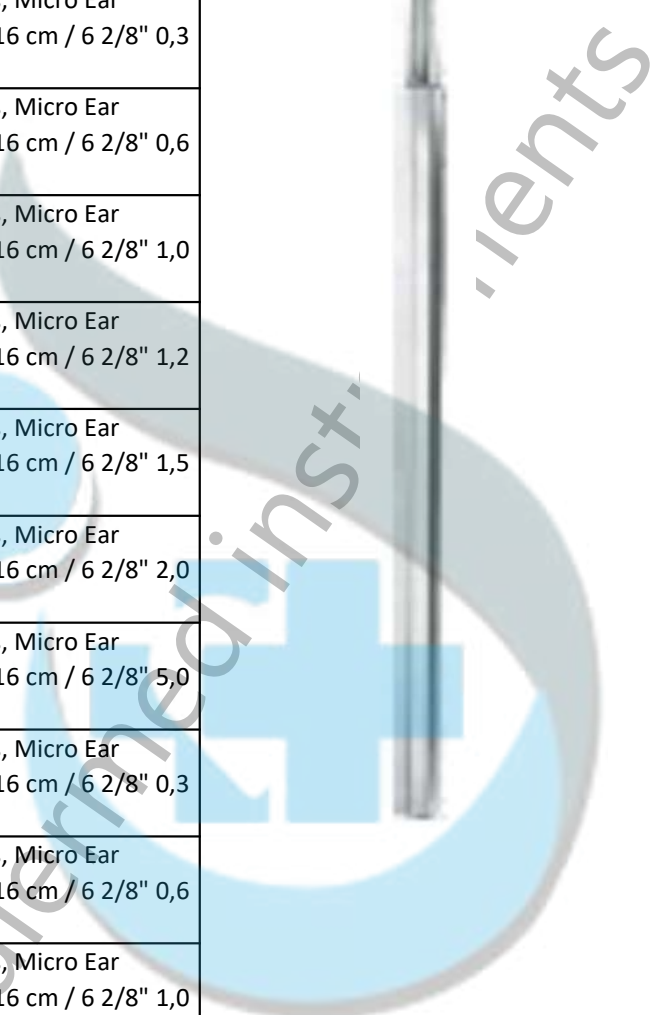



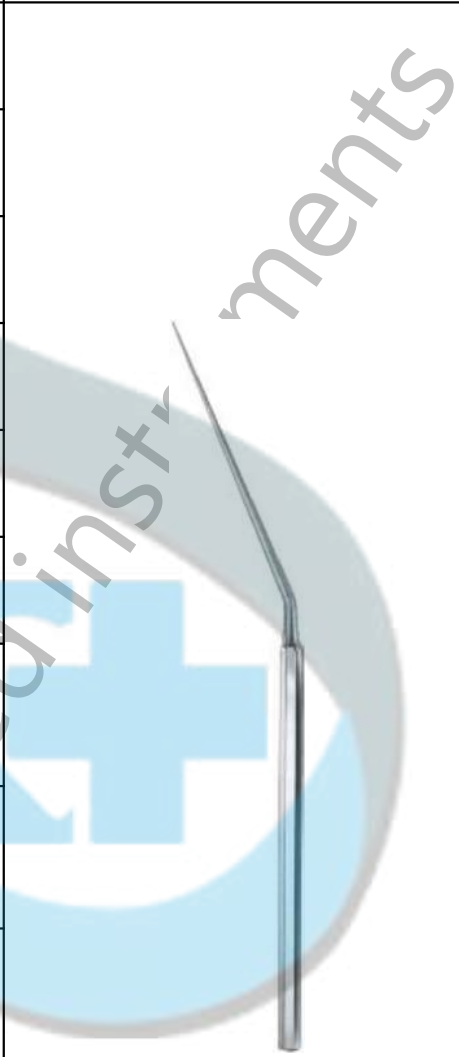

6042	HMI-SI-5996	Micro Ear Hooks, Micro Ear Needles Haken 16 cm / 6 2/8" 5,0 mm 90°
6043	HMI-SI-5997	Micro Ear Hooks, Micro Ear Needles 16 cm / 6 2/8" 0,5 mm
6044	HMI-SI-5998	Micro Ear Hooks, Micro Ear Needles 16 cm / 6 2/8" 1,0 mm
6045	HMI-SI-5999	Micro Ear Hooks, Micro Ear Needles 15,5 cm / 6 1/8" bent upwards 90° 0,3 mm
6046	HMI-SI-6000	Micro Ear Hooks, Micro Ear Needles 15,5 cm / 6 1/8" bent upwards 90° 0,6 mm
6047	HMI-SI-6001	Micro Ear Hooks, Micro Ear Needles 15,5 cm / 6 1/8" bent upwards 90° 1,0 mm
6048	HMI-SI-6002	Micro Ear Hooks, Micro Ear Needles 15,5 cm / 6 1/8" angled 90° 0,3 mm
6049	HMI-SI-6003	Micro Ear Hooks, Micro Ear Needles 15,5 cm / 6 1/8" angled 90° 0,6 mm
6050	HMI-SI-6004	Micro Ear Hooks, Micro Ear Needles 15,5 cm / 6 1/8" angled 90° 1,0 mm
6051	HMI-SI-6005	Micro Ear Hooks, Micro Ear Needles McGee for footplate 15,5 cm / 6 1/8" bent upwards 0,5 mm
6052	HMI-SI-6006	Micro Ear Hooks, Micro Ear Needles McGee for footplate 15,5 cm / 6 1/8" bent upwards 1,0 mm
6053	HMI-SI-6007	Micro Ear Hooks, Micro Ear Needles McGee for footplate 15,5 cm / 6 1/8" angled 0,5 mm
6054	HMI-SI-6008	Micro Ear Hooks, Micro Ear Needles McGee for footplate 15,5 cm / 6 1/8" angled 1,0 mm
6055	HMI-SI-6009	Micro Ear Hooks, Micro Ear Needles Barbara 15,5 cm / 6 1/8"



6056	HMI-SI-6010	Micro Ear Hooks, Micro Ear Needles Barbara 15,5 cm / 6 1/8"
6057	HMI-SI-6011	Micro Ear Hooks, Micro Ear Needles 15 cm / 5 7/8" 25° hook 0,3 mm
6058	HMI-SI-6012	Micro Ear Hooks, Micro Ear Needles 15 cm / 5 7/8" 25° hook 0,6 mm
6059	HMI-SI-6013	Micro Ear Hooks, Micro Ear Needles Shambaugh 15 cm / 5 7/8" 25° hook 1,0 mm
6060	HMI-SI-6014	Micro Ear Hooks, Micro Ear Needles 15 cm / 5 7/8" 45° hook 0,3 mm
6061	HMI-SI-6015	Micro Ear Hooks, Micro Ear Needles 15 cm / 5 7/8" 45° hook 0,6 mm
6062	HMI-SI-6016	Micro Ear Hooks, Micro Ear Needles Shambaugh 15 cm / 5 7/8" 45° hook 1,0 mm
6063	HMI-SI-6017	Micro Ear Hooks, Micro Ear Needles Shea 15 cm / 5 7/8" 45° Exploring Hook 2,0 mm Blunt
6064	HMI-SI-6018	Micro Ear Hooks, Micro Ear Needles Austin 15 cm / 5 7/8" 90° Exploring Hook 3,0 mm Blunt
6065	HMI-SI-6019	Micro Ear Hooks, Micro Ear Needles Fisch 15 cm / 5 7/8" angled to right
6066	HMI-SI-6020	Micro Ear Hooks, Micro Ear Needles Fisch 15 cm / 5 7/8" angled to left
6067	HMI-SI-6021	Micro Ear Hooks, Micro Ear Needles Fisch 15,5 cm / 6 1/8" angled to right



















6068	HMI-SI-6022	Micro Ear Hooks, Micro Ear Needles Fisch 15,5 cm / 6 1/8" angled to left	
6069	HMI-SI-6023	Micro Ear Hooks, Micro Ear Needles Rosen 15 cm / 5 7/8" Micro Ear Periosteal Elevator	
6070	HMI-SI-6024	Micro Curettes, Micro Measuring Rods House 15,5 cm / 6 1/8" Marking up to 3,5 mm	
6071	HMI-SI-6024(a)	Micro Curettes, Micro Measuring Rods House 15,5 cm / 6 1/8" Marking up to 4,0 mm	
6072	HMI-SI-6025	Micro Curettes, Micro Measuring Rods House 15,5 cm / 6 1/8" Marking up to 4,5 mm	
6073	HMI-SI-6026	Micro Curettes, Micro Measuring Rods House 15,5 cm / 6 1/8" Marking up to 5,0 mm	
6074	HMI-SI-6027	Micro Curettes, Micro Measuring Rods House 14,5 cm / 5 6/8" Ø 1,0 mm Ø 1,2 mm	
6075	HMI-SI-6028	Micro Curettes, Micro Measuring Rods House 14,5 cm / 5 6/8" Ø 1,5 mm Ø 1,8 mm	







6076	HMI-SI-6029	Micro Curettes, Micro Measuring Rods House 14,5 cm / 5 6/8" Ø 1,0 mm Ø 1,2 mm
6077	HMI-SI-6030	Ear Specula Hartmann 3,6 cm / 1 3/8" Ø 3,0 mm
6078	HMI-SI-6031	Ear Specula Hartmann 3,6 cm / 1 3/8" Ø 4,0 mm
6079	HMI-SI-6032	Ear Specula Hartmann 3,6 cm / 1 3/8" Ø 5,0 mm
6080	HMI-SI-6033	Ear Specula Hartmann 3,6 cm / 1 3/8" Ø 6,0 mm
6081	HMI-SI-6034	Ear Specula Hartmann 3,6 cm / 1 3/8" Ø 7,5 mm
6082	HMI-SI-6035	Ear Specula Hartmann 3,6 cm / 1 3/8" Ear Specula, set for children
6083	HMI-SI-6036	Ear Specula Hartmann 3,6 cm / 1 3/8" Ear Specula, set for adults
6084	HMI-SI-6037	Ear Specula Hartmann 3,6 cm / 1 3/8" Ear Specula, set for adults
6085	HMI-SI-6038	Ear Specula Hartmann Toynbee 3,6 cm / 1 3/8" Ø 4,0 mm
6086	HMI-SI-6039	Ear Specula Hartmann Toynbee 3,6 cm / 1 3/8" Ø 5,0 mm
6087	HMI-SI-6040	Ear Specula Hartmann Toynbee 3,6 cm / 1 3/8" Ø 6,0 mm
6088	HMI-SI-6041	Ear Specula Hartmann Toynbee 3,6 cm / 1 3/8" Ø 7,5 mm
6089	HMI-SI-6042	Ear Specula Hartmann Toynbee Ear Specula, set for adults
6090	HMI-SI-6042(a)	Ear Specula Hartmann Toynbee Ear Specula, set for adults
6091	HMI-SI-6043	Ear Specula Zöllner 3,8 cm / 1 4/8" oval, black 5,5 x 6,5 mm
6092	HMI-SI-6044	Ear Specula Zöllner 3,8 cm / 1 4/8" oval, black 6,5 x 7,5 mm
6093	HMI-SI-6045	Ear Specula Zöllner 3,8 cm / 1 4/8" oval, black 7,5 x 8,5 mm









6094	HMI-SI-6046	Ear Specula Zöllner 3,8 cm / 1 4/8" oval, black 8,5 x 9,5 mm	
6095	HMI-SI-6047	Ear Specula Zöllner 3,8 cm / 1 4/8" oval, black 9,5 x 10,5 mm	
6096	HMI-SI-6048	Ear Specula Zöllner 3,8 cm / 1 4/8" oval, black 10,5 x 11,5 mm	
6097	HMI-SI-6049	Ear Specula Zöllner 3,8 cm / 1 4/8" oval, black Ear Specula, set	
6098	HMI-SI-6050	Ear Specula Farrior 3,6 cm / 1 3/8" round, black Ø 5,5 mm	
6099	HMI-SI-6051	Ear Specula Farrior 3,6 cm / 1 3/8" round, black Ø 6,5 mm	
6100	HMI-SI-6052	Ear Specula Farrior 3,6 cm / 1 3/8" round, black Ø 7,5 mm	
6101	HMI-SI-6053	Ear Specula Farrior 3,6 cm / 1 3/8" round, black Ø 8,5 mm	
6102	HMI-SI-6054	Ear Specula Farrior 3,6 cm / 1 3/8" round, black Ø 9,5 mm	
6103	HMI-SI-6055	Ear Specula Farrior 3,6 cm / 1 3/8" round, black Ø 10,5 mm	
6104	HMI-SI-6056	Ear Specula Farrior 3,6 cm / 1 3/8" round, black Ø 11,5 mm	
6105	HMI-SI-6057	Ear Specula Ear Specula Storage Rack	
6106	HMI-SI-6058	Tuning Forks French C2 16	
6107	HMI-SI-6059	Tuning Forks French C1 32	
6108	HMI-SI-6060	Tuning Forks Hartmann C 64	







6109	HMI-SI-6061	Tuning Forks Hartmann C 128	
6110	HMI-SI-6062	Tuning Forks Hartmann C1 256	
6111	HMI-SI-6063	Tuning Forks Martin C 128 Al	
6112	HMI-SI-6064	Tuning Forks Martin C 256 Al	
6113	HMI-SI-6065	Tuning Forks Martin-Alloy C 512 Al	
6114	HMI-SI-6066	Tuning Forks Martin-Alloy C 1024 Al	
6115	HMI-SI-6067	Tuning Forks Martin-Alloy C 2048 Al	
6116	HMI-SI-6068	Tuning Forks Hartmann C 128	





6117	HMI-SI-6069	Tuning Forks Hartmann C1 256	
6118	HMI-SI-6070	Tuning Forks Hartmann C2 512	
6119	HMI-SI-6071	Tuning Forks Hartmann C3 1024	
6120	HMI-SI-6072	Tuning Forks Hartmann C4 2048	
6121	HMI-SI-6073	Tuning Forks Hartmann C5 4096	
6122	HMI-SI-6074	Tuning Forks Lucae C 128	
6123	HMI-SI-6075	Tuning Forks Lucae C1 256	
6124	HMI-SI-6076	Tuning Forks Lucae C2 512	





6125	HMI-SI-6077	Tuning Forks Lucae C3 1024	
6126	HMI-SI-6078	Tuning Forks Lucae C4 2048	
6127	HMI-SI-6079	Tuning Forks Lucae C5 4096	
6128	HMI-SI-6081	Tuning Forks Lucae C 128 moveable up to h	
6129	HMI-SI-6082	Tuning Forks Lucae C 128 Socket, only	
6130	HMI-SI-6083	Tuning Forks Hartmann C 128 moveable up to h	
6131	HMI-SI-6084	Tuning Forks Hartmann C1 256	
6132	HMI-SI-6085	Tuning Forks Hartmann Socket, only	



6133	HMI-SI-6086	Tuning Forks Damper white scale	
6134	HMI-SI-6087	Tuning Forks Damper black scale	
6135	HMI-SI-6088	Tuning Forks Knurled screw	
6136	HMI-SI-6089	Tuning Forks Weights, C 66	
6137	HMI-SI-6090	Tuning Forks Bakelit base	
6138	HMI-SI-6091	Tuning Forks Rydel-Seibert C 64 / c 128 also for neurology	
6139	HMI-SI-6092	Tuning Forks Neuro with hammer, pinwheel, brush and needle	
6140	HMI-SI-6093	Tuning Forks König A 109 moveable up to g	

6141	HMI-SI-6094	Tuning Forks a1 440	
6142	HMI-SI-6095	Ear Catheters, Polypus Snares Hartmann 15 cm / 5 7/8" Ø 3,0 mm	
6143	HMI-SI-6096	Ear Catheters, Polypus Snares Hartmann 15 cm / 5 7/8" Ø 3,5 mm	
6144	HMI-SI-6097	Ear Catheters, Polypus Snares Hartmann 15 cm / 5 7/8" Ø 4,0 mm	
6145	HMI-SI-6098	Ear Catheters, Polypus Snares shaft length 110 mm	
6146	HMI-SI-6099	Ear Catheters, Polypus Snares Krause 18,5 cm / 7 2/8" open tip	
6147	HMI-SI-6100	Ear Catheters, Polypus Snares Krause 18,5 cm / 7 2/8" closed tip	
6148	HMI-SI-6101	Ear Catheters, Polypus Snares Polypus Snares	



6149	HMI-SI-6102	Ear Catheters, Polypus Snares Snare Wire, coil of 10 m Ø 0,3 mm	
6150	HMI-SI-6103	Ear Catheters, Polypus Snares Snare Wire, coil of 10 m Ø 0,4 mm	
6151	HMI-SI-6104	Ear Forceps Trörltsch (Wilde) 10,5 cm / 4 1/8"	
6152	HMI-SI-6105	Ear Forceps Trörltsch (Wilde) 11 cm / 4 3/8"	
6153	HMI-SI-6106	Ear Forceps Trörltsch (Wilde) 12,5 cm / 4 7/8"	
6154	HMI-SI-6107	Ear Forceps Grünwald 14,5 cm / 5 6/8"	
6155	HMI-SI-6108	Ear Forceps Jansen 16 cm / 6 2/8"	
6156	HMI-SI-6109	Ear Forceps Jansen 21,5 cm / 8 4/8"	









6157	HMI-SI-6110	Ear Polypus Forceps Hartmann delicate pattern shaft length 65 mm	
6158	HMI-SI-6111	Ear Polypus Forceps Hartmann regular model shaft length 65 mm	
6159	HMI-SI-6112	Ear Polypus Forceps Buck 11,5 cm / 4 4/8" Foreign Body Lever	
6160	HMI-SI-6113	Ear Polypus Forceps Quire 10,5 cm / 4 1/8" Foreign Body Lever	
6161	HMI-SI-6114	Ear Polypus Forceps Hartmann-Wullstein 8,5 cm	
6162	HMI-SI-6115	Ear Polypus Forceps Hartmann-Wullstein 8,5 cm	
6163	HMI-SI-6116	Ear Polypus Forceps Hartmann 8,5 cm	
6164	HMI-SI-6117	Ear Polypus Forceps Hartmann 14 cm	
6165	HMI-SI-6118	Ear Polypus Forceps Hartmann-Herzfeld 8,5 cm Ø 2,0 mm	
6166	HMI-SI-6119	Ear Polypus Forceps Hartmann-Herzfeld 8,5 cm Ø 2,5 mm	
6167	HMI-SI-6120	Ear Polypus Forceps Hartmann-Herzfeld 8,5 cm Ø 3,0 mm	
6168	HMI-SI-6121	Ear Polypus Forceps Hartmann-Wullstein 8,5 cm Ø 3,0 mm	
6169	HMI-SI-6122	Ear Polypus Forceps Strümpel 8,5 cm	
6170	HMI-SI-6123	Ear Polypus Forceps Hartmann-Hoemann 8,5 cm Ø 2,0 mm	



6171	HMI-SI-6124	Mastoid Rongeurs Citelli Jaw width 3 mm angled upward 7,5 cm	
6172	HMI-SI-6125	Mastoid Rongeurs Beyer Jaw width 1 mm angled upward 9,5 cm	
6173	HMI-SI-6126	Mastoid Rongeurs Beyer Jaw width 2 mm angled upward 9,5 cm	
6174	HMI-SI-6127	Ear Currettes Langenbeck 13 cm / 5 1/8" blunt	
6175	HMI-SI-6128	Ear Currettes Shapleigh 15 cm / 5 7/8"	
6176	HMI-SI-6129	Ear Currettes Shapleigh 15 cm / 5 7/8"	
6177	HMI-SI-6130	Ear Currettes Buck 17 cm / 6 6/8" blunt Ø 2,1 mm	
6178	HMI-SI-6131	Ear Currettes Buck 17 cm / 6 6/8" blunt Ø 2,6 mm	









6179	HMI-SI-6132	Ear Currettes Buck 17 cm / 6 6/8" blunt Ø 3,2 mm	
6180	HMI-SI-6133	Ear Currettes Buck 17 cm / 6 6/8" blunt Ø 3,7 mm	
6181	HMI-SI-6134	Ear Currettes Buck 15 cm / 6 6/8" blunt Ø 1,8 mm	
6182	HMI-SI-6135	Ear Currettes Buck 15 cm / 6 6/8" blunt Ø 2,1 mm	
6183	HMI-SI-6136	Ear Currettes Buck 15 cm / 6 6/8" blunt Ø 2,6 mm	
6184	HMI-SI-6137	Ear Currettes Buck 15 cm / 6 6/8" blunt Ø 3,2 mm	
6185	HMI-SI-6138	Ear Currettes Buck 15 cm / 6 6/8" blunt Ø 3,7 mm	
6186	HMI-SI-6139	Ear Currettes Buck 15 cm / 6 6/8" blunt Ø 4,1 mm	
6187	HMI-SI-6140	Ear Currettes Buck 15 cm / 6 6/8" blunt Ø 4,4 mm	
6188	HMI-SI-6141	Ear Currettes Buck 15 cm / 6 6/8" sharp Ø 1,8 mm	
6189	HMI-SI-6142	Ear Currettes Buck 15 cm / 6 6/8" sharp Ø 2,1 mm	
6190	HMI-SI-6143	Ear Currettes Buck 15 cm / 6 6/8" sharp Ø 2,6 mm	
6191	HMI-SI-6144	Ear Currettes Buck 15 cm / 6 6/8" sharp Ø 3,2 mm	
6192	HMI-SI-6145	Ear Currettes Buck 15 cm / 6 6/8" sharp Ø 3,7 mm	
6193	HMI-SI-6146	Ear Currettes Buck 15 cm / 6 6/8" sharp Ø 4,1 mm	
6194	HMI-SI-6147	Ear Currettes Buck 15 cm / 6 6/8" sharp Ø 4,4 mm	
6195	HMI-SI-6148	Ear Scoop, Foreign Body Instruments Jansen 16 cm / 6 2/8" sharp	 





6196	HMI-SI-6149	Ear Scoop, Foreign Body Instruments Gross 13 cm / 5 1/8" blunt	
6197	HMI-SI-6150	Ear Scoop, Foreign Body Instruments Weber-Loch Weber-Loch blunt	
6198	HMI-SI-6151	Ear Scoop, Foreign Body Instruments Billeau 16,5 cm / 6 4/8" 2,5 mm	
6199	HMI-SI-6152	Ear Scoop, Foreign Body Instruments Billeau 16,5 cm / 6 4/8" 3,8 mm	
6200	HMI-SI-6153	Ear Scoop, Foreign Body Instruments Billeau 16,5 cm / 6 4/8" 5,0 mm	
6201	HMI-SI-6154	Ear Scoop, Foreign Body Instruments Moldenhauer 16 cm / 6 1/8" Foreign Body Lever	
6202	HMI-SI-6155	Ear Scoop, Foreign Body Instruments Zaufal 15 cm / 5 7/8" Foreign Body Lever	
6203	HMI-SI-6156	Ear Scoop, Foreign Body Instruments Hartmann 16 cm / 6 2/8" Ear Hooklet	





6204	HMI-SI-6157	Ear Scoop, Foreign Body Instruments Lucae 14 cm / 5 4/8" Ø 0,6 mm 2,3 mm	
6205	HMI-SI-6158	Ear Scoop, Foreign Body Instruments Lucae 14 cm / 5 4/8" Ø 0,8 mm 3,1 mm	
6206	HMI-SI-6159	Ear Scoop, Foreign Body Instruments Lucae 14 cm / 5 4/8" Ø 1,0 mm 4,2 mm	
6207	HMI-SI-6160	Ear Hooklet, Tympanum Needles Wagener 14 cm / 5 4/8"	
6208	HMI-SI-6161	Ear Hooklet, Tympanum Needles Wagener 14 cm / 5 4/8"	
6209	HMI-SI-6162	Ear Hooklet, Tympanum Needles Wagener 14 cm / 5 4/8"	
6210	HMI-SI-6163	Ear Hooklet, Tympanum Needles Wagener 14 cm / 5 4/8"	
6211	HMI-SI-6164	Ear Hooklet, Tympanum Needles Wagener 14 cm / 5 4/8"	
6212	HMI-SI-6165	Ear Hooklet, Tympanum Needles Wagener 14 cm / 5 4/8"	
6213	HMI-SI-6166	Ear Hooklet, Tympanum Needles Wagener 14 cm / 5 4/8"	
6214	HMI-SI-6167	Ear Hooklet, Tympanum Needles Day 17 cm / 6 6/8"	



6215	HMI-SI-6168	Ear Hooklet, Tympanum Needles Day 17 cm / 6 6/8"	
6216	HMI-SI-6169	Ear Hooklet, Tympanum Needles Politzer 17,5 cm / 6 7/8"	
6217	HMI-SI-6170	Ear Hooklet, Tympanum Needles Politzer 15,5 cm / 6 1/8" needle vertically	
6218	HMI-SI-6171	Ear Hooklet, Tympanum Needles Politzer 16 cm / 6 2/8" needle horizontally	
6219	HMI-SI-6172	Ear Hooklet, Tympanum Needles Politzer 18 cm / 7 1/8" needle vertically	
6220	HMI-SI-6173	Ear Hooklet, Tympanum Needles Politzer 17,5 cm / 6 7/8" needle horizontally	
6221	HMI-SI-6174	Ear Periosteal Elevators, Ear Scoop Lempert 20,5 cm / 8 1/8"	
6222	HMI-SI-6175	Ear Periosteal Elevators, Ear Scoop Lempert 18 cm / 7 1/8"	





6223	HMI-SI-6176	Ear Periosteal Elevators, Ear Scoop Lempert 21,5 cm / 8 4/8" sharp 1,5 mm	
6224	HMI-SI-6177	Ear Periosteal Elevators, Ear Scoop Lempert 21,5 cm / 8 4/8" sharp 2,0 mm	
6225	HMI-SI-6178	Ear Periosteal Elevators, Ear Scoop Lempert 21,5 cm / 8 4/8" sharp 2,2 mm	
6226	HMI-SI-6179	Ear Periosteal Elevators, Ear Scoop Lempert 21,5 cm / 8 4/8" sharp 2,5 mm	
6227	HMI-SI-6180	Ear Periosteal Elevators, Ear Scoop Lempert 21,5 cm / 8 4/8" sharp 2,7 mm	
6228	HMI-SI-6181	Ear Syringes Flexible Tube	
6229	HMI-SI-6182	Ear Syringes complete, self ylling in plastic pouch	
6230	HMI-SI-6183	Ear Syringes Rubber gasket	
6231	HMI-SI-6184	Ear Syringes Retention spring	
6232	HMI-SI-6185	Ear Syringes Syringe, only, 10 ml	





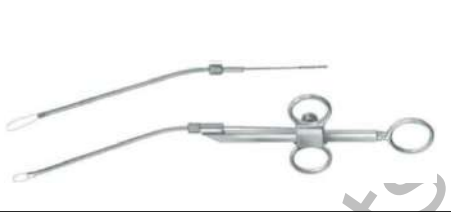
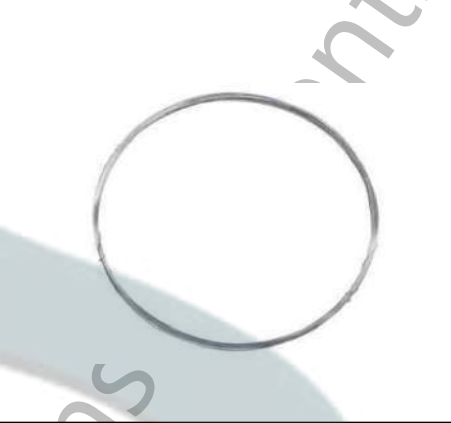

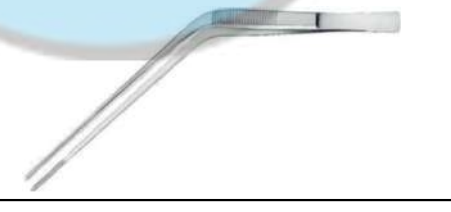
6233	HMI-SI-6186	Ear Syringes Valve Attachment	
6234	HMI-SI-6187	Ear Syringes Suction Nozzle	
6235	HMI-SI-6188	Ear Syringes Protecting Disc	
6236	HMI-SI-6189	Ear Syringes Metal Olive	
6237	HMI-SI-6190	Ear Syringes Conical Tip	
6238	HMI-SI-6191	Ear Syringes Button ended Tip	
6239	HMI-SI-6192	Ear Syringes Threaded Tip	
6240	HMI-SI-6193	Ear Syringes Irrigation adapter	



6241	HMI-SI-6194	Ear Syringes Irrigation adapter	
6242	HMI-SI-6195	Ear Syringes 50 ml complete with protection disc and 2 tips	
6243	HMI-SI-6196	Ear Syringes Ear Syringe	
6244	HMI-SI-6197	Ear Syringes 100 ml Complete with protection disc and 2 tips	
6245	HMI-SI-6198	Nasal Specula Goldsmith (Thudichum) 6,5 cm / 2 4/8" blades 18,5 x 9,5 mm	
6246	HMI-SI-6199	Nasal Specula Goldsmith (Thudichum) 6,5 cm / 2 4/8" blades 21,0 x 10,5 mm	
6247	HMI-SI-6200	Nasal Specula Goldsmith (Thudichum) 6,5 cm / 2 4/8" blades 21,0 x 11,5 mm	
6248	HMI-SI-6201	Nasal Specula Hartmann-Halle 16 cm / 6 2/8" blades 27 mm	

6249	HMI-SI-6202	Nasal Specula Hartmann-Halle 16 cm / 6 2/8" blades 31 mm	
6250	HMI-SI-6203	Nasal Specula Hartmann-Halle 16 cm / 6 2/8" blades 35 mm	
6251	HMI-SI-6204	Nasal Specula Martin 13 cm / 5 1/8" blades 17 mm	
6252	HMI-SI-6205	Nasal Specula Martin 13 cm / 5 1/8" blades 17 mm	
6253	HMI-SI-6206	Nasal Specula Tieck-Halle 13 cm / 5 1/8" blades 16 mm	
6254	HMI-SI-6207	Nasal Specula Killian 14 cm / 5 4/8" blades 35 mm	
6255	HMI-SI-6208	Nasal Specula Killian 14,5 cm / 5 6/8" blades 50 mm	
6256	HMI-SI-6209	Nasal Specula Killian 16 cm / 6 2/8" blades 75 mm	

6257	HMI-SI-6210	Nasal Specula Killian 17 cm / 6 6/8" blades 85 mm	
6258	HMI-SI-6211	Nasal Specula Mod. Wien 13,5 cm / 5 3/8" blade 30 mm	
6259	HMI-SI-6212	Nasal Specula Cottle 13,5 cm / 5 3/8" blades 35 mm	
6260	HMI-SI-6213	Nasal Specula Cottle 14 cm / 5 4/8" blades 50 mm	
6261	HMI-SI-6214	Nasal Specula Cottle 16 cm / 6 2/8" blades 75 mm	
6262	HMI-SI-6215	Nasal Specula Cottle 16 cm / 6 2/8" blades 85 mm	
6263	HMI-SI-6216	Nasal Specula Cottle black 14 cm / 5 4/8" blades 45 mm	
6264	HMI-SI-6217	Nasal Specula Cottle black 15,5 cm / 6 1/8" blades 75 mm	

6265	HMI-SI-6218	Polypus Snares Krause 26 cm / 10 2/8" shaft	
6266	HMI-SI-6219	Polypus Snares Krause-Voss 26 cm / 10 2/8" shaft	
6267	HMI-SI-6220	Polypus Snares Snare Wire coil of 10 m Ø 0,3 mm	
6268	HMI-SI-6221	Polypus Snares Snare Wire coil of 10 m Ø 0,4 mm	
6269	HMI-SI-6222	Polypus Snares 10,5 cm / 4" Snare Wire 0,3 mm Ø bundle with 12 pieces	
6270	HMI-SI-6223	Nasal Tampon Forceps, Nasal Tampon Forceps Tröltzsch 14,5 cm / 5 6/8"	
6271	HMI-SI-6224	Nasal Tampon Forceps, Nasal Tampon Forceps Tröltzsch 15,5 cm / 6 1/8"	
6272	HMI-SI-6225	Nasal Tampon Forceps, Nasal Tampon Forceps Grünwald (Jansen) 16 cm / 6 2/8"	

6273	HMI-SI-6226	Nasal Tampon Forceps, Nasal Tampon Forceps Grünwald (Jansen) 21,5 cm / 8 4/8"	
6274	HMI-SI-6227	Nasal Tampon Forceps, Nasal Tampon Forceps Westmacott 20 cm / 7 7/8"	
6275	HMI-SI-6228	Nasal Tampon Forceps, Nasal Tampon Forceps Lubet-Barbon 18,5 cm / 7 2/8"	
6276	HMI-SI-6229	Nasal Tampon Forceps, Nasal Tampon Forceps Hartmann 18,5 cm / 7 2/8" Nasal Polypus Forceps	
6277	HMI-SI-6230	Septum Forceps Knight 17 cm / 6 6/8" 5,0 mm	
6278	HMI-SI-6231	Septum Forceps Knight 16 cm / 6 2/8" 5,5 mm	
6279	HMI-SI-6232	Septum Forceps Knight 15,5 cm / 6 1/8" left curved 8,5 mm	
6280	HMI-SI-6233	Septum Forceps Knight 15,5 cm / 6 1/8" right curved 8,5 mm	



6281	HMI-SI-6234	Septum Forceps Knight Brünings 16,5 cm / 6 4/8" 6,6 mm	
6282	HMI-SI-6235	Septum Forceps Knight Brünings 16,5 cm / 6 4/8" 7,6 mm	
6283	HMI-SI-6236	Septum Forceps Knight Brünings 16,5 cm / 6 4/8" 8,7 mm	
6284	HMI-SI-6237	Septum Forceps Knight Brünings 16,5 cm / 6 4/8" 9,6 mm	
6285	HMI-SI-6238	Ethmoid Bone Forceps Takahashi Jaw width 3,5 mm straight 12 cm	
6286	HMI-SI-6239	Ethmoid Bone Forceps Takahashi Jaw width 3,5 mm 45° angled upward 12 cm	
6287	HMI-SI-6240	Ethmoid Bone Forceps Jaw 7,0 mm straight 12 cm Watson- Williams	
6288	HMI-SI-6241	Ethmoid Bone Forceps Jaw 8,0 mm straight 12 cm	



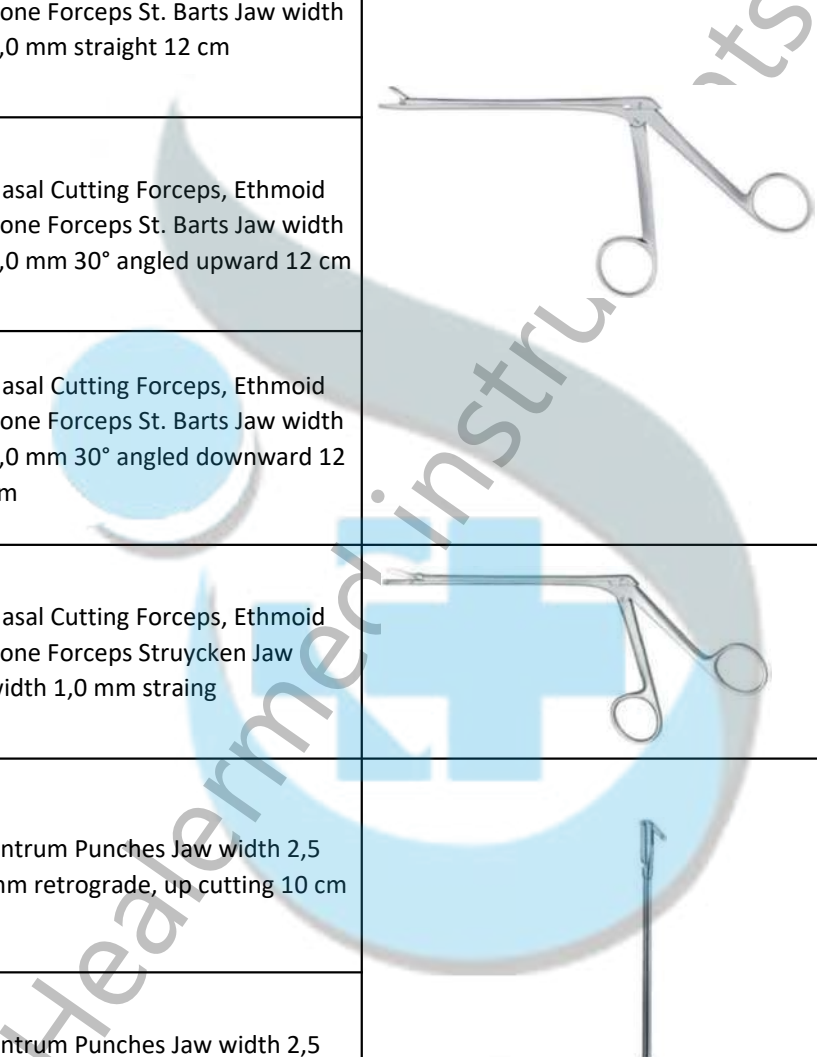



6289	HMI-SI-6242	Ethmoid Bone Forceps Jaw 5,5 mm straight Well 12 cm
6290	HMI-SI-6243	Nasal Cutting Forceps, Ethmoid Bone Forceps Weil-Blakesley Jaw width 3,0 mm straight
6291	HMI-SI-6244	Nasal Cutting Forceps, Ethmoid Bone Forceps Weil-Blakesley Jaw width 3,5 mm straight
6292	HMI-SI-6245	Nasal Cutting Forceps, Ethmoid Bone Forceps Weil-Blakesley Jaw width 4,5 mm straight
6293	HMI-SI-6246	Nasal Cutting Forceps, Ethmoid Bone Forceps Weil-Blakesley Jaw width 5,5 mm straight
6294	HMI-SI-6247	Nasal Cutting Forceps, Ethmoid Bone Forceps Weil-Blakesley Jaw width 6,0 mm straight
6295	HMI-SI-6248	Nasal Cutting Forceps, Ethmoid Bone Forceps Weil-Blakesley Jaw width 3,0 mm 45° angled upward
6296	HMI-SI-6249	Nasal Cutting Forceps, Ethmoid Bone Forceps Weil-Blakesley Jaw width 3,5 mm 45° angled upward
6297	HMI-SI-6250	Nasal Cutting Forceps, Ethmoid Bone Forceps Weil-Blakesley Jaw width 4,5 mm 45° angled upward
6298	HMI-SI-6251	Nasal Cutting Forceps, Ethmoid Bone Forceps Weil-Blakesley Jaw width 5,5 mm 45° angled upward
6299	HMI-SI-6252	Nasal Cutting Forceps, Ethmoid Bone Forceps Weil-Blakesley Jaw width 3,0 mm 90° angled upward
6300	HMI-SI-6253	Nasal Cutting Forceps, Ethmoid Bone Forceps Weil-Blakesley Jaw width 3,5 mm 90° angled upward





6301	HMI-SI-6254	Nasal Cutting Forceps, Ethmoid Bone Forceps Weil-Blakesley Jaw width 4,5 mm 90° angled upward	
6302	HMI-SI-6255	Nasal Cutting Forceps, Ethmoid Bone Forceps Weil-Blakesley Jaw width 5,5 mm 90° angled upward	
6303	HMI-SI-6256	Nasal Cutting Forceps, Ethmoid Bone Forceps St. Barts Jaw width 3,0 mm straight 12 cm	
6304	HMI-SI-6257	Nasal Cutting Forceps, Ethmoid Bone Forceps St. Barts Jaw width 3,0 mm 30° angled upward 12 cm	
6305	HMI-SI-6258	Nasal Cutting Forceps, Ethmoid Bone Forceps St. Barts Jaw width 3,0 mm 30° angled downward 12 cm	
6306	HMI-SI-6259	Nasal Cutting Forceps, Ethmoid Bone Forceps Struycken Jaw width 1,0 mm straight	
6307	HMI-SI-6260	Antrum Punches Jaw width 2,5 mm retrograde, up cutting 10 cm	
6308	HMI-SI-6261	Antrum Punches Jaw width 2,5 mm retrograde, right cutting 10 cm	
6309	HMI-SI-6262	Antrum Punches Jaw width 2,5 mm retrograde, left cutting 10 cm	









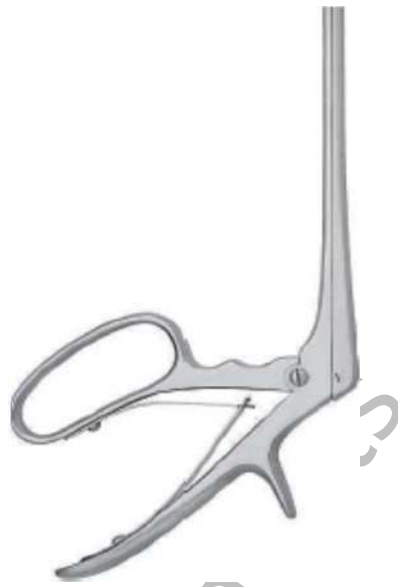

6310	HMI-SI-6263	Nasal Cutting Forceps Hartmann Jaw width \varnothing 5,0 mm 12 cm	
6311	HMI-SI-6264	Nasal Cutting Forceps Hartmann Jaw width \varnothing 7,0 mm 12 cm	
6312	HMI-SI-6265	Nasal Cutting Forceps Hartmann Jaw width \varnothing 9,0 mm 12 cm	
6313	HMI-SI-6266	Nasal Cutting Forceps Hartmann Jaw width \varnothing 11,0 mm 12 cm	
6314	HMI-SI-6267	Nasal Cutting Forceps Schmieden Jaw width \varnothing 8,0 mm 12 cm	
6315	HMI-SI-6268	Septum Forceps, Septum Morselizer Middleton-Jansen 20,5 cm / 8 1/8"	
6316	HMI-SI-6269	Septum Forceps, Septum Morselizer Middleton-Jansen 20 cm / 7 7/8"	
6317	HMI-SI-6270	Septum Forceps, Septum Morselizer Caplan 20 cm / 7 7/8" one toothed cutting edge	





6318	HMI-SI-6271	Septum Forceps, Septum Morselizer TCGOLD 20 cm / 7 7/8"	
6319	HMI-SI-6272	Septum Morselizers Rubin 20 cm / 7 7/8"	
6320	HMI-SI-6273	Septum Morselizers Rubin 18,5 cm / 7 2/8"	
6321	HMI-SI-6274	Septum Morselizers TCGOLD Rubin 18,5 cm / 7 2/8"	
6322	HMI-SI-6275	Septum Morselizers Rubin Protection Cap	
6323	HMI-SI-6276	Sphenoid Bone Punches Hajek Jaw width 3,5 mm 90° cutting upward 14 cm	
6324	HMI-SI-6277	Sphenoid Bone Punches Hajek Jaw width 3,5 mm 90° cutting downward 14 cm	
6325	HMI-SI-6278	Sphenoid Bone Punches Hajek Jaw width 4 mm 90° cutting upward 14 cm	





6326	HMI-SI-6279	Sphenoid Bone Punches Hajek Jaw width 4 mm 90° cutting downward 14 cm	
6327	HMI-SI-6280	Sphenoid Bone Punches Ferris-Smith-Kerrison Jaw width 3 mm 90° cutting upward	
6328	HMI-SI-6281	Sphenoid Bone Punches Ferris-Smith-Kerrison Jaw width 3 mm 90° cutting downward	
6329	HMI-SI-6282	Sphenoid Bone Punches Ferris-Smith-Kerrison Jaw width 3 mm 40° cutting downward	
6330	HMI-SI-6282(a)	Sphenoid Bone Punches Ferris-Smith-Kerrison Jaw width 5 mm 90° cutting upward	
6331	HMI-SI-6283	Sphenoid Bone Punches Ferris-Smith-Kerrison Jaw width 5 mm 90° cutting downward	
6332	HMI-SI-6284	Sphenoid Bone Punches Ferris-Smith-Kerrison Jaw width 5 mm 40° cutting downward	
6333	HMI-SI-6285	Sphenoid Bone Punches Jaw width 10 x 2 mm straight 18 cm	
6334	HMI-SI-6286	Sphenoid Bone Punches Jaw width 10 x 2 mm 30° angled upward 18 cm	









6335	HMI-SI-6287	Sphenoid Bone Punches Jaw width 10 x 2 mm 30° angled downward 18 cm
6336	HMI-SI-6288	Sphenoid Bone Punches Jaw width 10 x 3 mm straight 18 cm
6337	HMI-SI-6289	Sphenoid Bone Punches Jaw width 10 x 3 mm 30° angled upward 18 cm
6338	HMI-SI-6290	Sphenoid Bone Punches Jaw width 10 x 3 mm 30° angled downward 18 cm
6339	HMI-SI-6291	Sphenoid Bone Punches Jaw width 10 x 4 mm straight 18 cm
6340	HMI-SI-6292	Sphenoid Bone Punches Jaw width 10 x 4 mm 30° angled upward 18 cm
6341	HMI-SI-6293	Sphenoid Bone Punches Jaw width 10 x 4 mm 30° angled downward 18 cm
6342	HMI-SI-6294	Sphenoid Bone Punches Jaw width 10 x 5 mm straight 18 cm
6343	HMI-SI-6295	Sphenoid Bone Punches Jaw width 10 x 6 mm straight 18 cm
6344	HMI-SI-6296	Antrum Punches Kerrison Jaw width 3 x 3 mm 90° cutting upward 9 cm
6345	HMI-SI-6297	Antrum Punches Kerrison Jaw width 4 x 4 mm 90° cutting upward 9 cm
6346	HMI-SI-6298	Antrum Punches Kerrison Jaw width 5 x 5 mm 90° cutting upward 9 cm













6347	HMI-SI-6299	Antrum Punches Kerrison Jaw width 6 x 6 mm 90° cutting upward 9 cm	
6348	HMI-SI-6300	Rhinoplastic Knives Joseph 15 cm / 5 7/8"	
6349	HMI-SI-6301	Rhinoplastic Knives Joseph 15 cm / 5 7/8"	
6350	HMI-SI-6302	Rhinoplastic Knives Fomon 16,5 cm / 6 4/8"	
6351	HMI-SI-6303	Rhinoplastic Knives Converse 16 cm / 6 2/8"	
6352	HMI-SI-6304	Rhinoplastic Knives Joseph 15,5 cm / 6 1/8"	
6353	HMI-SI-6305	Rhinoplastic Knives Cottle 14 cm / 5 4/8"	
6354	HMI-SI-6306	Septum Knives, Swivel Knives Freer 16,5 cm / 6 4/8" Mucosa Knife	





6355	HMI-SI-6307	Septum Knives, Swivel Knives Freer 19 cm / 7 4/8"	
6356	HMI-SI-6308	Septum Knives, Swivel Knives Freer 18,5 cm / 7 2/8"	
6357	HMI-SI-6309	Septum Knives, Swivel Knives Ballenger 21 cm / 8 2/8" 3 mm	
6358	HMI-SI-6310	Septum Knives, Swivel Knives Ballenger 21 cm / 8 2/8" 4 mm	
6359	HMI-SI-6311	Septum Knives, Swivel Knives Ballenger 21 cm / 8 2/8" 5 mm	
6360	HMI-SI-6313	Septum Knives, Swivel Knives Ballenger 20,5 cm / 8 1/8" 3 mm	
6361	HMI-SI-6314	Septum Knives, Swivel Knives Ballenger 20,5 cm / 8 1/8" 4 mm	
6362	HMI-SI-6315	Septum Knives, Swivel Knives Ballenger 20,5 cm / 8 1/8" 5 mm	





6363	HMI-SI-6316	Septum Elevators McKenty 15 cm / 5 7/8" 4 mm	
6364	HMI-SI-6317	Septum Elevators McKenty 15 cm / 5 7/8" 5 mm	
6365	HMI-SI-6318	Septum Elevators Halle 16 cm / 6 2/8"	
6366	HMI-SI-6319	Septum Elevators Joseph 16,5 cm / 6 4/8"	
6367	HMI-SI-6320	Septum Elevators Freer 19 cm / 7 4/8" 5 mm sharp	
6368	HMI-SI-6321	Septum Elevators Freer 19 cm / 7 4/8" 5 mm blunt	
6369	HMI-SI-6322	Septum Elevators Krenkel Cleft Palate Periosteal Rasapatory 24,5 cm / 9 5/8"	
6370	HMI-SI-6323	Septum Elevators Krenkel Cleft Palate Periosteal Rasapatory 24 cm / 9 4/8"	

6371	HMI-SI-6324	Septum Elevators Freer 18 cm / 7 1/8" without pin in handle, sharp / blunt	
6372	HMI-SI-6325	Septum Elevators Freer 18 cm / 7 1/8"	
6373	HMI-SI-6326	Septum Elevators Freer 21 cm / 8 2/8"	
6374	HMI-SI-6327	Septum Elevators McKenty 20,5 cm / 8 1/8"	
6375	HMI-SI-6328	Septum Elevators Ballenger-Hajek 19 cm / 7 4/8"	
6376	HMI-SI-6329	Septum Elevators Howard 21,5 cm / 8 4/8"	
6377	HMI-SI-6330	Septum Elevators Cottle 23,5 cm / 9 2/8"	
6378	HMI-SI-6331	Septum Elevators Killian 18 cm / 7 1/8"	

6379	HMI-SI-6332	Septum Elevators Killian 23,5 cm / 9 2/8"	
6380	HMI-SI-6333	Periosteal Elevators Pennington 21,5 cm / 8 4/8"	
6381	HMI-SI-6334	Periosteal Elevators Roger 20 cm / 7 7/8"	
6382	HMI-SI-6335	Periosteal Elevators Joseph-Masing 21,5 cm / 8 4/8"	
6383	HMI-SI-6336	Periosteal Elevators Cottle 23 cm / 9"	
6384	HMI-SI-6337	Periosteal Elevators Masing 19,5 cm / 7 5/8"	
6385	HMI-SI-6338	Periosteal Elevators Cottle 22 cm / 8 5/8"	
6386	HMI-SI-6339	Periosteal Elevators Joseph 18 cm / 7 1/8"	





6387	HMI-SI-6340	Septum Chisels, Septum Gouges Freer 16,5 cm / 6 4/8"	
6388	HMI-SI-6341	Septum Chisels, Septum Gouges Freer 16,5 cm / 6 4/8"	
6389	HMI-SI-6342	Septum Chisels, Septum Gouges Freer 16 cm / 6 2/8"	
6390	HMI-SI-6343	Septum Chisels, Septum Gouges Ballenger 15 cm / 5 7/8" 2 mm	
6391	HMI-SI-6344	Septum Chisels, Septum Gouges Ballenger 15 cm / 5 7/8" 4 mm	
6392	HMI-SI-6345	Septum Chisels, Septum Gouges Ballenger 15 cm / 5 7/8" 6 mm	
6393	HMI-SI-6346	Septum Chisels, Septum Gouges Ballenger 15 cm / 5 7/8" 8 mm	
6394	HMI-SI-6347	Septum Chisels, Septum Gouges Killian 16 cm / 6 2/8"	



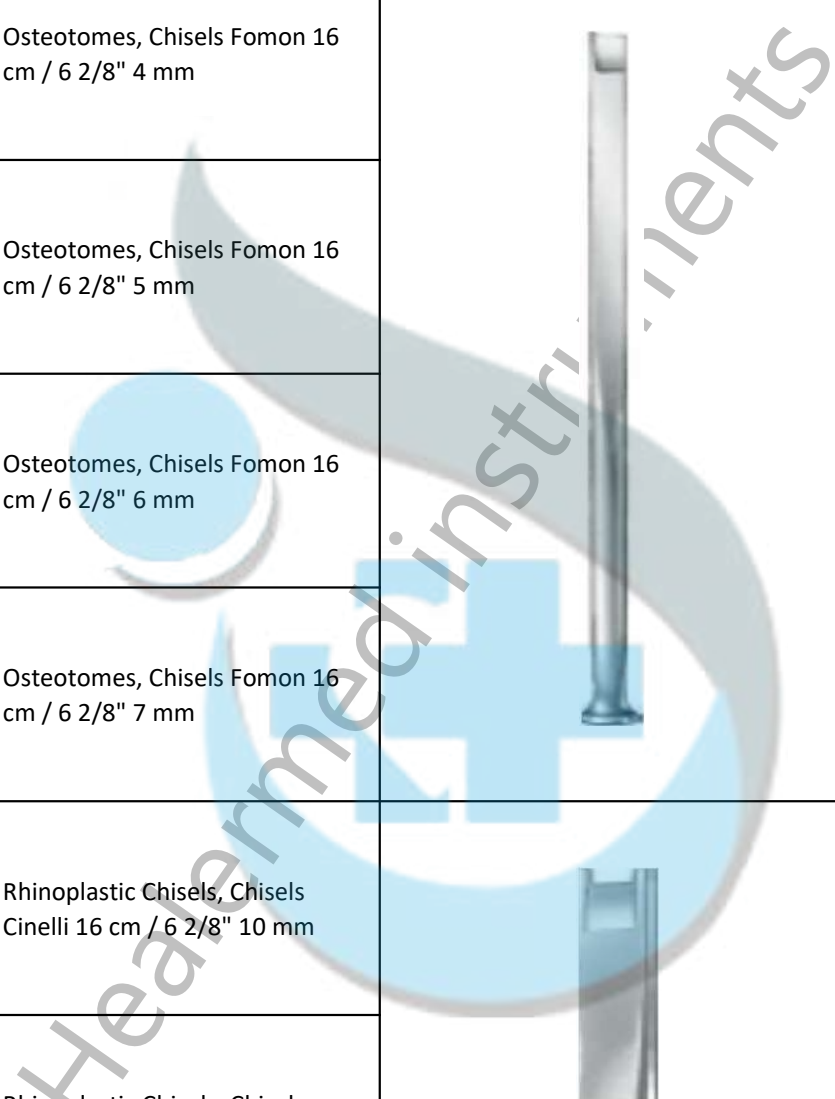



6395	HMI-SI-6348	Septum Chisels, Septum Gouges Killian-Claus 16 cm / 6 2/8"		
6396	HMI-SI-6349	Osteotomes Cottle 18,5 cm / 7 2/8" 4 mm		
6397	HMI-SI-6350	Osteotomes Cottle 18,5 cm / 7 2/8" 7 mm		
6398	HMI-SI-6351	Osteotomes Cottle 18,5 cm / 7 2/8" 9 mm		
6399	HMI-SI-6352	Osteotomes Cottle 18,5 cm / 7 2/8" 12 mm		
6400	HMI-SI-6353	Osteotomes Cottle 18,5 cm / 7 2/8" 6 mm		
6401	HMI-SI-6354	Osteotomes Cottle 18,5 cm / 7 2/8" 2 mm		
6402	HMI-SI-6355	Osteotomes Cottle 18,5 cm / 7 2/8" 4 mm		
6403	HMI-SI-6356	Osteotomes Cottle 18,5 cm / 7 2/8" 7 mm		
6404	HMI-SI-6357	Osteotomes Cottle 18,5 cm / 7 2/8" 9 mm		
6405	HMI-SI-6358	Osteotomes Cottle 18,5 cm / 7 2/8" 12 mm		







6406	HMI-SI-6359	Osteotomes Cottle 18,5 cm / 7 2/8" 12 mm	
6407	HMI-SI-6360	Osteotomes Cottle 18,5 cm / 7 2/8" 12 mm	
6408	HMI-SI-6361	Osteotomes Cottle 18,5 cm / 7 2/8" 12 mm	
6409	HMI-SI-6362	Osteotomes, Chisels Rubin 18,5 cm / 7 2/8" 10 mm	
6410	HMI-SI-6363	Osteotomes, Chisels Rubin 18,5 cm / 7 2/8" 12 mm	
6411	HMI-SI-6364	Osteotomes, Chisels Rubin 18,5 cm / 7 2/8" 14 mm	
6412	HMI-SI-6365	Osteotomes, Chisels Walter 19 cm / 7 4/8" 3 mm	
6413	HMI-SI-6366	Osteotomes, Chisels Walter 19 cm / 7 4/8" 4,5 mm	
6414	HMI-SI-6367	Osteotomes, Chisels Walter 19 cm / 7 4/8" 3 mm	



6415	HMI-SI-6368	Osteotomes, Chisels Walter 19 cm / 7 4/8" 4 mm
6416	HMI-SI-6369	Osteotomes, Chisels Walter 19 cm / 7 4/8" 7 mm
6417	HMI-SI-6370	Osteotomes, Chisels Walter 19 cm / 7 4/8" 9 mm
6418	HMI-SI-6371	Osteotomes, Chisels Walter 19 cm / 7 4/8" 12 mm
6419	HMI-SI-6372	Osteotomes, Chisels Fomon 16 cm / 6 2/8" 4 mm
6420	HMI-SI-6373	Osteotomes, Chisels Fomon 16 cm / 6 2/8" 5 mm
6421	HMI-SI-6374	Osteotomes, Chisels Fomon 16 cm / 6 2/8" 6 mm
6422	HMI-SI-6375	Osteotomes, Chisels Fomon 16 cm / 6 2/8" 7 mm
6423	HMI-SI-6376	Rhinoplastic Chisels, Chisels Cinelli 16 cm / 6 2/8" 10 mm
6424	HMI-SI-6377	Rhinoplastic Chisels, Chisels Cinelli 16 cm / 6 2/8" 12 mm
6425	HMI-SI-6378	Rhinoplastic Chisels, Chisels Cinelli 16 cm / 6 2/8" 14 mm











6426	HMI-SI-6379	Rhinoplastic Chisels, Chisels Cinelli 16 cm / 6 2/8" 16 mm	
6427	HMI-SI-6380	Rhinoplastic Chisels, Chisels Neivert-Anderson 20,5 cm / 8 1/8" 7 mm	
6428	HMI-SI-6381	Rhinoplastic Chisels, Chisels Neivert-Anderson 20,5 cm / 8 1/8" 7 mm	
6429	HMI-SI-6382	Rhinoplastic Chisels, Chisels Neivert-Anderson 20,5 cm / 8 1/8" 7 mm	
6430	HMI-SI-6383	Rhinoplastic Chisels, Chisels Silver 18 cm / 7 1/8"	
6431	HMI-SI-6384	Rhinoplastic Chisels, Chisels Silver 18 cm / 7 1/8"	
6432	HMI-SI-6385	Rhinoplastic Chisels, Chisels Silver 18 cm / 7 1/8"	
6433	HMI-SI-6386	Rhinoplastic Chisels, Chisels Parkes 16 cm / 6 2/8"	





6434	HMI-SI-6387	Nasal Saws Joseph angled to left 17 cm / 6 6/8"	
6435	HMI-SI-6388	Nasal Saws Joseph angled to right 17 cm / 6 6/8"	
6436	HMI-SI-6389	Nasal Saws Joseph 19 cm / 7 4/8" working length 40 mm	
6437	HMI-SI-6390	Nasal Saws Joseph 19 cm / 7 4/8" working length 40 mm	
6438	HMI-SI-6391	Nasal Saws Joseph 19 cm / 7 4/8" working length 40 mm	
6439	HMI-SI-6393	Cartilage Crusher Cottle 12 cm / 4 6/8" Handle	
6440	HMI-SI-6394	Cartilage Crusher Cottle Guide Support for osteotomes 7 mm wide	
6441	HMI-SI-6395	Cartilage Crusher Cottle Cartilage Crusher	







6442	HMI-SI-6396	Nasal Rasps, Bone Files, Antrum Rasps Maltz 17 cm / 6 6/8" drawing cut 34 x 7 mm	
6443	HMI-SI-6397	Nasal Rasps, Bone Files, Antrum Rasps Maltz 17 cm / 6 6/8" pushing cut 34 x 7 mm	
6444	HMI-SI-6398	Nasal Rasps, Bone Files, Antrum Rasps Josep 16 cm / 6 2/8"	
6445	HMI-SI-6399	Nasal Rasps, Bone Files, Antrum Rasps Cottle 21 cm / 8 2/8" drawing cut 34 x 8 mm	
6446	HMI-SI-6400	Glabella Rasps, Nasal Rasps Aufricht 21 cm / 8 2/8" 32 x 9 mm pushing cut	
6447	HMI-SI-6401	Glabella Rasps, Nasal Rasps Aufricht 21 cm / 8 2/8" 32 x 9 mm drawing cut	
6448	HMI-SI-6402	Glabella Rasps, Nasal Rasps Lewis 19 cm / 7 4/8" 15 x 8 mm pushing cut	
6449	HMI-SI-6403	Glabella Rasps, Nasal Rasps Lewis 19 cm / 7 4/8" 15 x 8 mm drawing cut	





6450	HMI-SI-6404	Glabella Rasps, Nasal Rasps Fomon 20,5 cm / 8 1/8 7,0 mm	
6451	HMI-SI-6405	Nasal Rasps TCGOLD Maltz 21 cm / 8 2/8"	
6452	HMI-SI-6406	Nasal Rasps TCGOLD Maltz 21 cm / 8 2/8"	
6453	HMI-SI-6407	Nasal Rasps TCGOLD Maltz 21 cm / 8 2/8"	
6454	HMI-SI-6408	Nasal Rasps TCGOLD Maltz 21 cm / 8 2/8"	
6455	HMI-SI-6409	Nasal Rasps TCGOLD Maltz 21 cm / 8 2/8"	
6456	HMI-SI-6410	Nasal Rasps TCGOLD Maltz 21 cm / 8 2/8"	
6457	HMI-SI-6411	Nasal Rasps TCGOLD Maltz 21 cm / 8 2/8"	
6458	HMI-SI-6412	Nasal Rasps TCGOLD Maltz 21 cm / 8 2/8"	
6459	HMI-SI-6413	Nasal Rasps TCGOLD Maltz 21 cm / 8 2/8"	
6460	HMI-SI-6414	Nasal Rasps TCGOLD Maltz 21 cm / 8 2/8"	
6461	HMI-SI-6415	Nasal Rasps TCGOLD Fomon 20,5 cm / 8 1/8" 30 x 8 mm	
6462	HMI-SI-6416	Nasal Rasps TCGOLD Fomon 20,5 cm / 8 1/8" 40 x 7 mm	
6463	HMI-SI-6417	Nasal Rasps TCGOLD Fomon 20,5 cm / 8 1/8" 40 x 7 mm	
6464	HMI-SI-6418	Nasal Rasps TCGOLD Fomon 20,5 cm / 8 1/8" 40 x 7 mm	
6465	HMI-SI-6419	Nasal Rasps TCGOLD Fomon 20,5 cm / 8 1/8" 40 x 7 mm	
6466	HMI-SI-6420	Nasal Rasps TCGOLD Fomon 20,5 cm / 8 1/8" 40 x 7 mm	
6467	HMI-SI-6421	Nasal Hooklets Joseph 15,5 cm / 6 1/8" Hooklet, sharp	
6468	HMI-SI-6422	Nasal Hooklets Cottle 17 cm / 6 1/8" sharp 6,3 mm 130°	





6469	HMI-SI-6423	Nasal Hooklets Cottle 17 cm / 6 1/8" sharp 3,3 mm 160°	
6470	HMI-SI-6424	Nasal Hooklets Cottle 14,5 cm / 5 6/8" sharp 3,7 mm 130°	
6471	HMI-SI-6425	Nasal Hooklets Cottle 14,5 cm / 5 6/8" sharp 4,0 mm 160°	
6472	HMI-SI-6426	Nasal Hooklets Cottle 14,5 cm / 5 6/8" sharp 4,2 mm 160°	
6473	HMI-SI-6427	Nasal Hooklets Lange 23 cm / 9" Alar Hooklet, button end Ø 2 mm 160°	
6474	HMI-SI-6428	Nasal Hooklets Fomon 17 cm / 6 6/8" Alar Hooklet, button end Ø 1,75 mm 160°	
6475	HMI-SI-6429	Nasal Hooklets Aufricht 19 cm / 7 4/8" Nasal Retractors	
6476	HMI-SI-6430	Alar Hooklets, Mucosa Hooklet Kilner 8 cm / 3 1/8" sharp	



6477	HMI-SI-6431	Alar Hooklets, Mucosa Hooklet Converse 10,5 cm / 4 1/8" Nasal Retractors	
6478	HMI-SI-6432	Alar Hooklets, Mucosa Hooklet Converse 11,5 cm / 4 4/8" sharp	
6479	HMI-SI-6433	Alar Hooklets, Mucosa Hooklet Freer 15 cm / 5 7/8" sharp	
6480	HMI-SI-6434	Alar Hooklets, Mucosa Hooklet Joseph 16 cm / 6 1/8" 2 mm	
6481	HMI-SI-6435	Alar Hooklets, Mucosa Hooklet Joseph 16 cm / 6 1/8" 5 mm	
6482	HMI-SI-6436	Alar Hooklets, Mucosa Hooklet Joseph 16 cm / 6 1/8" 7 mm	
6483	HMI-SI-6437	Alar Hooklets, Mucosa Hooklet Joseph 16 cm / 6 1/8" 10 mm	
6484	HMI-SI-6438	Alar Hooklets, Mucosa Hooklet Fomon 16 cm / 6 2/8" button ended	







6485	HMI-SI-6439	Alar Hooklets, Nasal Retractors Cottle-Neivert 19,5 cm / 7 5/8"	
6486	HMI-SI-6440	Alar Hooklets, Nasal Retractors Cottle 14,5 cm / 5 6/8" sharp 12,0 mm	
6487	HMI-SI-6441	Alar Hooklets, Nasal Retractors Cottle 14,5 cm / 5 6/8" blunt/sharp 11,3 mm	
6488	HMI-SI-6442	Alar Hooklets, Nasal Retractors Cottle 14,5 cm / 5 6/8" sharp/blunt 11,3 mm	
6489	HMI-SI-6443	Alar Hooklets, Nasal Retractors Cottle 14 cm / 5 4/8" 7,8 mm	
6490	HMI-SI-6445	Alar Hooklets, Nasal Retractors Neivert 17 cm / 6 6/8"	
6491	HMI-SI-6446	Alar Hooklets, Nasal Retractors Cottle 14 cm / 5 8/8" Saddle Hook	
6492	HMI-SI-6447	Alar Hooklets, Nasal Retractors Cottle 16 cm / 6 2/8"	







6493	HMI-SI-6448	Alar Hooklets, Nasal Retractors Aufricht 12 cm / 4 6/8" blunt	
6494	HMI-SI-6449	Septum Forceps, Septum Straightening Forceps Kressner 22 cm / 8 5/8"	
6495	HMI-SI-6450	Septum Forceps, Septum Straightening Forceps Cottle-Walsham 23 cm / 9" straight	
6496	HMI-SI-6451	Septum Forceps, Septum Straightening Forceps Cottle-Walsham 23 cm / 9" left	
6497	HMI-SI-6452	Septum Forceps, Septum Straightening Forceps Cottle-Walsham 23 cm / 9" right	
6498	HMI-SI-6453	Septum Forceps, Septum Straightening Forceps Asch 22,5 cm / 8 7/8"	
6499	HMI-SI-6454	Skin Grasping Forceps, Antrum Currettes Ogura 11 cm / 4 3/8"	
6500	HMI-SI-6455	Skin Grasping Forceps, Antrum Currettes Cottle 14 cm / 5 4/8" with teeth	





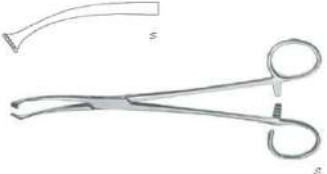
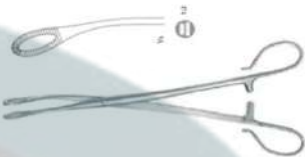



6501	HMI-SI-6456	Skin Grasping Forceps, Antrum Curettes Cottle 11 cm / 4 3/8" Columella Forceps		
6502	HMI-SI-6457	Skin Grasping Forceps, Antrum Curettes Faulkner 21 cm / 8 2/8"		
6503	HMI-SI-6458	Skin Grasping Forceps, Antrum Curettes Coakley 17 cm / 6 6/8"		
6504	HMI-SI-6459	Skin Grasping Forceps, Antrum Curettes Coakley 17 cm / 6 6/8"		
6505	HMI-SI-6460	Skin Grasping Forceps, Antrum Curettes Coakley 17 cm / 6 6/8"		
6506	HMI-SI-6461	Skin Grasping Forceps, Antrum Curettes Coakley 17 cm / 6 6/8"		
6507	HMI-SI-6462	Skin Grasping Forceps, Antrum Curettes Coakley 17 cm / 6 6/8"		
6508	HMI-SI-6463	Skin Grasping Forceps, Antrum Curettes Coakley 17 cm / 6 6/8"		
6509	HMI-SI-6464	Adenoid Curettes, Suction Rasparatory, Frontal Sinus Dilators Beckmann 22 cm / 8 5/8" 13 mm		
6510	HMI-SI-6465	Adenoid Curettes, Suction Rasparatory, Frontal Sinus Dilators Beckmann 22 cm / 8 5/8" 15 mm		
6511	HMI-SI-6466	Adenoid Curettes, Suction Rasparatory, Frontal Sinus Dilators Beckmann 22 cm / 8 5/8" 17 mm		
6512	HMI-SI-6467	Adenoid Curettes, Suction Rasparatory, Frontal Sinus Dilators Beckmann 22 cm / 8 5/8" 19 mm		
6513	HMI-SI-6468	Adenoid Curettes, Suction Rasparatory, Frontal Sinus Dilators Beckmann 22 cm / 8 5/8" 21 mm		





6514	HMI-SI-6469	Adenoid Currettes, Suction Rasparatory, Frontal Sinus Dilators Beckmann 22 cm / 8 5/8" 23 mm	
6515	HMI-SI-6470	Adenoid Currettes, Suction Rasparatory, Frontal Sinus Dilators Beckmann 21,5 cm / 8 4/8" 13 mm	
6516	HMI-SI-6471	Adenoid Currettes, Suction Rasparatory, Frontal Sinus Dilators Beckmann 21,5 cm / 8 4/8" 15 mm	
6517	HMI-SI-6472	Adenoid Currettes, Suction Rasparatory, Frontal Sinus Dilators Beckmann 21,5 cm / 8 4/8" 17 mm	
6518	HMI-SI-6473	Adenoid Currettes, Suction Rasparatory, Frontal Sinus Dilators Beckmann 21,5 cm / 8 4/8" 19 mm	
6519	HMI-SI-6474	Adenoid Currettes, Suction Rasparatory, Frontal Sinus Dilators Beckmann 21,5 cm / 8 4/8" 21 mm	
6520	HMI-SI-6475	Adenoid Currettes, Suction Rasparatory, Frontal Sinus Dilators Beckmann 21,5 cm / 8 4/8" 23 mm	
6521	HMI-SI-6476	Adenoid Currettes, Suction Rasparatory, Frontal Sinus Dilators Eicken-Killian 14 cm / 5 4/8" Irrigation Cannula, with Luer-Lock	
6522	HMI-SI-6477	Adenoid Currettes, Suction Rasparatory, Frontal Sinus Dilators Eicken-Killian 14 cm / 5 4/8" Irrigation Cannula, with Luer-Lock	
6522	HMI-SI-6478	Adenoid Currettes, Suction Rasparatory, Frontal Sinus Dilators Guilen 19 cm / 7 4/8"	









6523	HMI-SI-6479	Adenoid Currettes, Suction Rasparatory, Frontal Sinus Dilators Guilen 19 cm / 7 4/8" Obturator	
6524	HMI-SI-6480	Adenoid Currettes, Suction Rasparatory, Frontal Sinus Dilators Ritter-Halle 14,5 cm / 5 6/8" Ø 3,0 mm	
6525	HMI-SI-6481	Adenoid Currettes, Suction Rasparatory, Frontal Sinus Dilators Ritter-Halle 14,5 cm / 5 6/8" Ø 4,0 mm	
6526	HMI-SI-6482	Cleft Palate Instruments Salyer 18 cm / 7 1/8" 3,9 mm Cleft Palate Hooklet, short	
6527	HMI-SI-6483	Cleft Palate Instruments Salyer 18 cm / 7 1/8" 5,5 mm Cleft Palate Hooklet, long	
6528	HMI-SI-6484	Cleft Palate Instruments Salyer 18 cm / 7 1/8" 3,3 mm Cleft Palate Dissector, short	
6529	HMI-SI-6485	Cleft Palate Instruments Salyer 18 cm / 7 1/8" 3,7 mm Cleft Palate Dissector, long	
6530	HMI-SI-6486	Cleft Palate Instruments Salyer 18 cm / 7 1/8" 3,7 mm Cleft Palate Instruments	
6531	HMI-SI-6487	Cleft Palate Instruments Salyer 18 cm / 7 1/8" 3,7 mm Cleft Palate Instruments	
6532	HMI-SI-6488	Cleft Palate Instruments Salyer 18 cm / 7 1/8" 3,6 mm Cleft Palate Elevator	
6533	HMI-SI-6489	Cleft Palate Instruments Salyer 18 cm / 7 1/8" 2,9 mm Cleft Palate Elevator, graduated	
6534	HMI-SI-6490	Cleft Palate Instruments 14 cm / 5 4/8" left 4,0 mm	







6535	HMI-SI-6491	Cleft Palate Instruments 14 cm / 5 4/8" right 4,0 mm	
6536	HMI-SI-6492	Tonsil Knife, Tonsil Dissectors Fisher 22,5 cm / 8 7/8"	
6537	HMI-SI-6492(a)	Tonsil Knife, Tonsil Dissectors Brünings 23 cm / 9"	
6538	HMI-SI-6492(b)	Tonsil Knife, Tonsil Dissectors Carpenter 25 cm / 9 7/8" Tonsil Knife- / Eucleator	
6539	HMI-SI-6492(c)	Tonsil Knife, Tonsil Dissectors Hurd 22,5 cm / 8 7/8" Tonsil Dissector / Retractor	
6540	HMI-SI-6493	Tonsil Dissectors, Gauze Packers Henke 24,5 cm / 9 5/8" 11,5 mm	
6541	HMI-SI-6494	Tonsil Dissectors, Gauze Packers Henke 24,5 cm / 9 5/8" 6,5 mm	
6542	HMI-SI-6495	Tonsil Dissectors, Gauze Packers Luniatschek 17,5 cm / 6 7/8" 3 mm	

6543	HMI-SI-6496	Tonsil Dissectors, Gauze Packers Luniatschek 17,5 cm / 6 7/8" 2 mm	
6544	HMI-SI-6497	Tonsil Dissectors, Gauze Packers Luniatschek 17,5 cm / 6 7/8"	
6545	HMI-SI-6498	Tonsil Forceps White 18 cm / 7 1/8" Tonsil Grasping Forceps	
6546	HMI-SI-6499	Tonsil Forceps Blohmke 20 cm / 7 1/8" Tonsil Grasping Forceps	
6547	HMI-SI-6500	Tonsil Forceps Schnidt 19 cm / 7 4/8"	
6548	HMI-SI-6501	Tonsil Forceps Schnidt 18,5 cm / 7 2/8"	
6549	HMI-SI-6502	Tonsil Forceps Schnidt 19 cm / 7 4/8"	
6550	HMI-SI-6503	Tonsil Forceps Schnidt 18,5 cm / 7 2/8"	

6551	HMI-SI-6504	Tonsil Snare Eves 28,5 cm / 11 2/8" without ratchet shaft Ø 6,0 mm	
6552	HMI-SI-6505	Tonsil Snare Eves 28,5 cm / 11 2/8" with ratchet shaft Ø 6,0 mm	
6553	HMI-SI-6506	Tonsil Snare Brünings 29 cm / 11 3/8" with double ratchet shaft tip	
6554	HMI-SI-6507	Tonsil Snare Wire Loop, package of 100 pieces Ø 40 x 0,3 mm	
6555	HMI-SI-6508	Tonsil Snare Wire Loop, package of 100 pieces Ø 50 x 0,3 mm	
6556	HMI-SI-6509	Tonsil Snare Snare Wire, package of 100 pieces Ø 0,3 mm	
6557	HMI-SI-6510	Tonsil Snare Tyding with one straight tip	
6558	HMI-SI-6511	Broncho-Esophagoscopy Forceps Hartmann Tonsil Punchthrough-cutting shaft length 120 mm cut Ø 13 mm	

6559	HMI-SI-6512	Broncho-Esophagoscopy Forceps Hartmann Tonsil Punchthrough-cutting shaft length 120 mm cut \varnothing 15 mm	
6560	HMI-SI-6513	Broncho-Esophagoscopy Forceps Huber for interchangeable tubes	
6561	HMI-SI-6514	Broncho-Esophagoscopy Forceps Brünings 22 cm / 8 5/8"	
6562	HMI-SI-6515	Broncho-Esophagoscopy Forceps Brünings 32 cm / 12 5/8"	
6563	HMI-SI-6516	Broncho-Esophagoscopy Forceps Brünings 41 cm / 16 1/8"	
6564	HMI-SI-6517	Broncho-Esophagoscopy Forceps Brünings 18 cm / 7 1/8"	
6565	HMI-SI-6518	Broncho-Esophagoscopy Forceps Fraenkel 3,0 mm	
6566	HMI-SI-6519	Broncho-Esophagoscopy Forceps Seibert 2,5 mm	

6567	HMI-SI-6520	Broncho-Esophagoscopy Forceps Fraenkel 4,0 mm	
6568	HMI-SI-6521	Broncho-Esophagoscopy Forceps Scheinmann 8,0 mm	
6569	HMI-SI-6522	Broncho-Esophagoscopy Forceps Scheinmann 4,0 mm	
6570	HMI-SI-6523	Broncho-Esophagoscopy Forceps Brünings 3,0 mm	
6571	HMI-SI-6524	Broncho-Esophagoscopy Forceps Brünings 4,0 mm	
6572	HMI-SI-6525	Exchangeable Tips Brünings 2,0 mm	
6573	HMI-SI-6526	Exchangeable Tips Brünings 4,0 mm	
6574	HMI-SI-6527	Exchangeable Tips Krause 3,0 mm	
6575	HMI-SI-6528	Exchangeable Tips Krause 4,0 mm	
6576	HMI-SI-6529	Exchangeable Tips Cordes 3,0 mm	
6577	HMI-SI-6530	Exchangeable Tips Cordes 4,0 mm	
6578	HMI-SI-6531	Exchangeable Tips Cordes 5,0 mm	
6579	HMI-SI-6532	Exchangeable Tips Cordes 5,5 mm	
6580	HMI-SI-6533	Exchangeable Tips Cordes 4,5 mm	
6581	HMI-SI-6534	Exchangeable Tips Cordes 6,9 mm	

6582	HMI-SI-6534(a)	Exchangeable Tips Rosenberg 4,0 mm	
6583	HMI-SI-6535	Exchangeable Tips Lange 3,0 mm	
6584	HMI-SI-6536	Exchangeable Tips Krause 4,5 mm	
6585	HMI-SI-6537	Exchangeable Tips Schumacher 4,0 mm	
6586	HMI-SI-6538	Exchangeable Tips Cordes 3,5 mm	
6587	HMI-SI-6539	Laryngeal Mirrors 18,5 cm / 7 2/8" plane, with fixed handle Ø 16 mm	
6588	HMI-SI-6540	Laryngeal Mirrors 18,5 cm / 7 2/8" plane, with fixed handle Ø 18 mm	
6589	HMI-SI-6541	Laryngeal Mirrors 18,5 cm / 7 2/8" plane, with fixed handle Ø 20 mm	
6590	HMI-SI-6542	Laryngeal Mirrors 18,5 cm / 7 2/8" plane, with fixed handle Ø 22 mm	
6591	HMI-SI-6543	Laryngeal Mirrors 18,5 cm / 7 2/8" plane, with fixed handle Ø 24 mm	
6592	HMI-SI-6544	Laryngeal Mirrors 18,5 cm / 7 2/8" plane, with fixed handle Ø 26 mm	

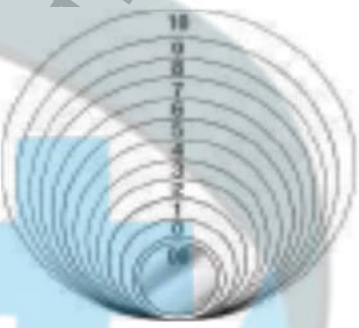

6593	HMI-SI-6545	Laryngeal Mirrors 18,5 cm / 7 2/8" plane, with fixed handle Ø 28 mm
6594	HMI-SI-6546	Laryngeal Mirrors 18,5 cm / 7 2/8" plane, with fixed handle Ø 30 mm
6595	HMI-SI-6547	Laryngeal Mirrors 18,5 cm / 7 2/8" plane, with fixed handle rhodium plated Ø 8 mm
6596	HMI-SI-6548	Laryngeal Mirrors 18,5 cm / 7 2/8" plane, with fixed handle rhodium plated Ø 10 mm
6597	HMI-SI-6549	Laryngeal Mirrors 18,5 cm / 7 2/8" plane, with fixed handle rhodium plated Ø 12 mm
6598	HMI-SI-6550	Laryngeal Mirrors 18,5 cm / 7 2/8" plane, with fixed handle rhodium plated Ø 14 mm
6599	HMI-SI-6551	Laryngeal Mirrors 18,5 cm / 7 2/8" plane, with fixed handle rhodium plated Ø 16 mm
6600	HMI-SI-6552	Laryngeal Mirrors 18,5 cm / 7 2/8" plane, with fixed handle rhodium plated Ø 18 mm
6601	HMI-SI-6553	Laryngeal Mirrors 18,5 cm / 7 2/8" plane, with fixed handle rhodium plated Ø 20 mm
6602	HMI-SI-6554	Laryngeal Mirrors 18,5 cm / 7 2/8" plane, with fixed handle rhodium plated Ø 22 mm
6603	HMI-SI-6555	Laryngeal Mirrors 18,5 cm / 7 2/8" plane, with fixed handle rhodium plated Ø 24 mm
6604	HMI-SI-6556	Laryngeal Mirrors 18,5 cm / 7 2/8" plane, with fixed handle rhodium plated Ø 26 mm
6605	HMI-SI-6557	Laryngeal Mirrors 18,5 cm / 7 2/8" plane, with fixed handle rhodium plated Ø 28 mm
6606	HMI-SI-6558	Laryngeal Mirrors 18,5 cm / 7 2/8" plane, with fixed handle rhodium plated Ø 30 mm
6607	HMI-SI-6559	Laryngeal Mirrors 13,5 cm / 5 3/8" plane, without handle Ø 16 mm
6608	HMI-SI-6560	Laryngeal Mirrors 13,5 cm / 5 3/8" plane, without handle Ø 18 mm















6609	HMI-SI-6561	Laryngeal Mirrors 13,5 cm / 5 3/8" plane, without handle Ø 20 mm
6610	HMI-SI-6562	Laryngeal Mirrors 13,5 cm / 5 3/8" plane, without handle Ø 22 mm
6611	HMI-SI-6563	Laryngeal Mirrors 13,5 cm / 5 3/8" plane, without handle Ø 24 mm
6612	HMI-SI-6564	Laryngeal Mirrors 13,5 cm / 5 3/8" plane, without handle Ø 26 mm
6613	HMI-SI-6565	Laryngeal Mirrors 13,5 cm / 5 3/8" plane, without handle Ø 28 mm
6614	HMI-SI-6566	Laryngeal Mirrors 13,5 cm / 5 3/8" plane, without handle Ø 30 mm
6615	HMI-SI-6567	Laryngeal Mirrors 13,5 cm / 5 3/8" plane, without handle rhodium plated Ø 8 mm
6616	HMI-SI-6568	Laryngeal Mirrors 13,5 cm / 5 3/8" plane, without handle rhodium plated Ø 10 mm
6617	HMI-SI-6569	Laryngeal Mirrors 13,5 cm / 5 3/8" plane, without handle rhodium plated Ø 12 mm
6618	HMI-SI-6570	Laryngeal Mirrors 13,5 cm / 5 3/8" plane, without handle rhodium plated Ø 14 mm
6619	HMI-SI-6571	Laryngeal Mirrors 13,5 cm / 5 3/8" plane, without handle rhodium plated Ø 16 mm
6620	HMI-SI-6572	Laryngeal Mirrors 13,5 cm / 5 3/8" plane, without handle rhodium plated Ø 18 mm
6621	HMI-SI-6573	Laryngeal Mirrors 13,5 cm / 5 3/8" plane, without handle rhodium plated Ø 20 mm
6622	HMI-SI-6574	Laryngeal Mirrors 13,5 cm / 5 3/8" plane, without handle rhodium plated Ø 22 mm
6623	HMI-SI-6575	Laryngeal Mirrors 13,5 cm / 5 3/8" plane, without handle rhodium plated Ø 24 mm
6624	HMI-SI-6576	Laryngeal Mirrors 13,5 cm / 5 3/8" plane, without handle rhodium plated Ø 26 mm















S,









6625	HMI-SI-6577	Laryngeal Mirrors 13,5 cm / 5 3/8" plane, without handle rhodium plated Ø 28 mm	
6626	HMI-SI-6578	Laryngeal Mirrors 13,5 cm / 5 3/8" plane, without handle rhodium plated Ø 30 mm	
6627	HMI-SI-6579	Laryngeal Mirrors, Laryngeal Mirror Handles Michel 27 cm / 10 5/8" Ø 12 mm	
6628	HMI-SI-6580	Laryngeal Mirrors, Laryngeal Mirror Handles Michel 27 cm / 10 5/8" Ø 14 mm	
6629	HMI-SI-6581	Laryngeal Mirrors, Laryngeal Mirror Handles Michel 27 cm / 10 5/8" Ø 16 mm	
6630	HMI-SI-6582	Laryngeal Mirrors, Laryngeal Mirror Handles Michel 27 cm / 10 5/8" Ø 18 mm	
6631	HMI-SI-6583	Laryngeal Mirrors, Laryngeal Mirror Handles 11 cm / 4 4/8"	
6632	HMI-SI-6584	Laryngeal Mirrors, Laryngeal Mirror Handles 12,5 cm / 4 7/8"	
6633	HMI-SI-6585	Laryngeal Polypus Forceps Jurasz 23 cm / 9"	



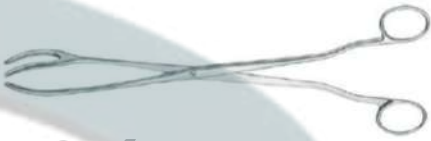

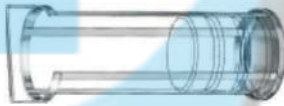

6634	HMI-SI-6586	Laryngeal Polypus Forceps Jurasz 23 cm / 9"	
6635	HMI-SI-6587	Laryngeal Polypus Forceps Jurasz 23 cm / 9"	
6636	HMI-SI-6588	Laryngeal Polypus Forceps Jurasz 23 cm / 9"	
6637	HMI-SI-6589	Hand and Nail Brush, Brush Dispensers Martin-Aseptic 110 x 40 x 35 mm (l x b x h) plastic, more than 400 x autoclavable	
6638	HMI-SI-6590	Hand and Nail Brush, Brush Dispensers Martin 265 x 165 x 65 mm for 10 brushes (without brushes) with suspension	
6639	HMI-SI-6591	Hand and Nail Brush, Brush Dispensers Martin 275 x 240 x 65 mm for 20 brushes (without brushes) with suspension	
6640	HMI-SI-6592	Accessories for Brush Dispensers plastic	
6641	HMI-SI-6593	Accessories for Brush Dispensers Brush Collecting Box with suspension	





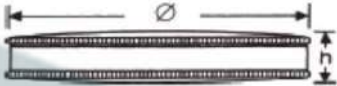

6642	HMI-SI-6594	Nail Scissors nail scissors and nail file with chain	
6643	HMI-SI-6595	Nail Scissors 10,5 cm / 4 1/8"	
6644	HMI-SI-6596	Nail Scissors 14 cm / 5 4/8"	
6645	HMI-SI-6597	Nail Scissors 14 cm / 5 4/8"	
6646	HMI-SI-6598	Nail Scissors 16 cm / 6 2/8"	
6647	HMI-SI-6599	Nail Scissors Turnbull 12 cm / 4 6/8"	
6648	HMI-SI-6600	Nail Scissors Turnbull 12 cm / 4 6/8"	
6649	HMI-SI-6601	Nail Scissors Turnbull 13 cm / 5 1/8"	





6650	HMI-SI-6602	Nail Scissors Turnbull 12 cm / 4 6/8"	
6651	HMI-SI-6603	Nail Nippers, Cuticle Nippers, Cuticle Scissors, Nail Files straight cutting edges 10 cm / 3 7/8"	
6652	HMI-SI-6604	Nail Nippers, Cuticle Nippers, Cuticle Scissors, Nail Files straight cutting edges 13 cm / 5 1/8"	
6653	HMI-SI-6605	Nail Nippers, Cuticle Nippers, Cuticle Scissors, Nail Files straight cutting edges 15 cm / 5 7/8"	
6654	HMI-SI-6606	Nail Nippers, Cuticle Nippers, Cuticle Scissors, Nail Files 11 cm / 4 3/8"	
6655	HMI-SI-6607	Nail Nippers, Cuticle Nippers, Cuticle Scissors, Nail Files 13 cm / 5 1/8"	
6656	HMI-SI-6608	Nail Nippers, Cuticle Nippers, Cuticle Scissors, Nail Files delicate pattern 11 cm / 4 3/8"	
6657	HMI-SI-6609	Nail Nippers, Cuticle Nippers, Cuticle Scissors, Nail Files delicate pattern 10,5 cm / 4 1/8"	

6658	HMI-SI-6610	Nail Nippers, Cuticle Nippers, Cuticle Scissors, Nail Files delicate pattern 11,5 cm / 4 4/8"	
6659	HMI-SI-6611	Nail Nippers, Cuticle Nippers, Cuticle Scissors, Nail Files delicate pattern 10,5 cm / 4 1/8"	
6660	HMI-SI-6612	Nail Nippers, Cuticle Nippers, Cuticle Scissors, Nail Files delicate pattern 11,5 cm / 4 4/8"	
6661	HMI-SI-6613	Nail Nippers, Cuticle Nippers, Cuticle Scissors, Nail Files delicate pattern 9 cm / 3 4/8"	
6662	HMI-SI-6614	Nail Nippers, Cuticle Nippers, Cuticle Scissors, Nail Files delicate pattern 11 cm / 4 3/8"	
6663	HMI-SI-6615	Nail Nippers, Cuticle Nippers, Cuticle Scissors, Nail Files sapphire coating 16 cm / 6 2/8"	
6664	HMI-SI-6616	Protection Spectacles, Face Protection Mask Zeller	
6665	HMI-SI-6617	Protection Spectacles, Face Protection Mod. Martin	

6666	HMI-SI-6618	Protection Spectacles, Face Protection Protecting Shield	
6667	HMI-SI-6619	Protection Spectacles, Face Protection Head Band	
6668	HMI-SI-6620	Sterilizing Forceps, Storage Rack for Petri Dishes Cheattle 27 cm / 10 5/8"	
6669	HMI-SI-6621	Sterilizing Forceps, Storage Rack for Petri Dishes 30 cm / 11 6/8"	
6670	HMI-SI-6622	Sterilizing Forceps, Storage Rack for Petri Dishes for up to 10 dishes of Ø 8 - 10 cm, with fixation device	
6671	HMI-SI-6623	Sterilizing Forceps, Storage Rack for Petri Dishes for up to 10 dishes of Ø 8 - 10 cm, with fixation device	
6672	HMI-SI-6624	Needle Cases Sauerbruch 210 x 125 x 17 mm perforated lid and bottom	
6673	HMI-SI-6625	Needle Cases Sauerbruch 210 x 125 x 17 mm perforated lid and bottom	
6674	HMI-SI-6626	Needle Cases Sauerbruch 50 x 25 x 4,5 mm	

6675	HMI-SI-6627	Needle Cases Sauerbruch 65 x 42 x 8 mm	
6676	HMI-SI-6628	Needle Cases Sauerbruch 75 x 25 x 4,5 mm	
6677	HMI-SI-6629	Needle Cases Sauerbruch 50 x 25 x 4,5 mm	
6678	HMI-SI-6630	Needle Cases Sauerbruch 65 x 42 x 8 mm	
6679	HMI-SI-6631	Needle Cases Sauerbruch 75 x 25 x 4,5 mm	
6680	HMI-SI-6632	Needle Cases h = 18 mm Ø 67 mm complete with perforated interior box	
6681	HMI-SI-6633	Needle Cases h = 15 mm Ø 61 mm Interior Box, perforated lid and bottom	
6682	HMI-SI-6634	Needle Cases 150 x 95 x 13 mm	
6683	HMI-SI-6635	Needle Cases 150 x 95 x 13 mm, perforated lid and bottom	
6684	HMI-SI-6636	Needle Cases 150 x 95 x 13 mm perforated bottom	
6685	HMI-SI-6637	Needle Cases 150 x 95 x 13 mm perforated lid and bottom	

6686	HMI-SI-6638	Needle Cases, Storing Cup 150 x 95 x 13 mm	
6687	HMI-SI-6639	Needle Cases, Storing Cup 150 x 95 x 13 mm perforated lid and bottom	
6688	HMI-SI-6640	Needle Cases, Storing Cup 150 x 95 x 11 mm Needle Tray, perforated bottom	
6689	HMI-SI-6641	Needle Cases, Storing Cup h = 75 mm Ø 75 mm for micro instruments, with exchangeable silicone plate	
6690	HMI-SI-6642	Needle Cases, Storing Cup Silicone plate	
6691	HMI-SI-6643	Dressing Forceps in jar with cap, Safety Pins Mod. Martin jar 20,5 cm high, with 25 cm long dressing forceps	
6692	HMI-SI-6644	Dressing Forceps in jar with cap, Safety Pins Mod. Martin jar 25,5 cm high, with 32 cm long dressing forceps	
6693	HMI-SI-6645	Dressing Forceps in jar with cap, Safety Pins Mayo 14 cm / 5 4/8"	



6694	HMI-SI-6646	Dressing Forceps in jar with cap, Safety Pins Mayo 14 cm / 5 4/8"	
6695	HMI-SI-6647	Stainless Steel Bowls, Measurers Ø 330 mm x 90 mm 6.000 ccm	
6696	HMI-SI-6648	Stainless Steel Bowls, Measurers Ø 330 mm x 115 mm 8.000 ccm	
6697	HMI-SI-6649	Stainless Steel Bowls, Measurers Ø 40 x 19 mm 20 ccm	
6698	HMI-SI-6650	Stainless Steel Bowls, Measurers Ø 61 x 30 mm 70 ccm	
6699	HMI-SI-6651	Stainless Steel Bowls, Measurers Ø 80 x 40 mm 140 ccm	
6700	HMI-SI-6652	Stainless Steel Bowls, Measurers Ø 116 x 50 mm 250 ccm	
6701	HMI-SI-6653	Stainless Steel Bowls, Measurers Ø 128 x 55 mm 350 ccm	
6702	HMI-SI-6654	Stainless Steel Bowls, Measurers Ø 147 x 65 mm 500 ccm	
6703	HMI-SI-6655	Stainless Steel Bowls, Measurers Ø 167 x 75 mm 900 ccm	
6704	HMI-SI-6656	Stainless Steel Bowls, Measurers Ø 187 x 85 mm 1300 ccm	
6705	HMI-SI-6657	Stainless Steel Bowls, Measurers Ø 116 x 35 mm 200 ccm	
6706	HMI-SI-6658	Stainless Steel Bowls, Measurers Ø 128 x 38 mm 300 ccm	

6707	HMI-SI-6659	Stainless Steel Bowls, Measurers Ø 147 x 50 mm 400 ccm	
6708	HMI-SI-6660	Stainless Steel Bowls, Measurers Ø 167 x 45 mm 500 ccm	
6709	HMI-SI-6661	Stainless Steel Bowls, Measurers Ø 187 x 45 mm 800 ccm	
6710	HMI-SI-6662	Stainless Steel Bowls, Measurers graduated inside = 100 ccm	
6711	HMI-SI-6663	Stainless Steel Bowls, Measurers graduated inside = 250 ccm	
6712	HMI-SI-6664	Stainless Steel Bowls, Measurers graduated inside = 500 ccm	
6713	HMI-SI-6665	Stainless Steel Bowls, Measurers graduated inside = 1000 ccm	
6714	HMI-SI-6666	Stainless Steel Bowls, Measurers graduated inside = 2000 ccm	
6715	HMI-SI-6667	Universal Trays = 230 x 155 x 30 mm	
6716	HMI-SI-6668	Universal Trays = 300 x 175 x 30 mm	
6717	HMI-SI-6669	Universal Trays = 300 x 175 x 40 mm	
6718	HMI-SI-6670	Universal Trays = 350 x 240 x 40 mm	
6719	HMI-SI-6671	Universal Trays = 470 x 320 x 50 mm	
6720	HMI-SI-6672	Universal Trays = 210 x 160 x 11 mm	
6721	HMI-SI-6673	Universal Trays = 240 x 180 x 8 mm	
6722	HMI-SI-6674	Universal Trays = 310 x 150 x 11 mm	
6723	HMI-SI-6675	Universal Trays = 310 x 160 x 11 mm	
6724	HMI-SI-6676	Universal Trays = 350 x 235 x 10 mm	
6725	HMI-SI-6677	Universal Trays = 425 x 290 x 18 mm	



6726	HMI-SI-6678	Universal Trays = 400 x 300 x 12 mm	
6727	HMI-SI-6679	Universal Trays = 235 x 190 x 40 mm	
6728	HMI-SI-6680	Universal Trays = Ø 220 mm x 70 mm	
6729	HMI-SI-6681	Metal Jars, Instrument Boxes = 30 mm x 90 mm	
6730	HMI-SI-6682	Metal Jars, Instrument Boxes = 50 mm x 100 mm	
6731	HMI-SI-6683	Metal Jars, Instrument Boxes = 50 mm x 130 mm	
6732	HMI-SI-6684	Metal Jars, Instrument Boxes = 50 mm x 175 mm	
6733	HMI-SI-6685	Metal Jars, Instrument Boxes = 75 mm x 100 mm	
6734	HMI-SI-6686	Metal Jars, Instrument Boxes = 75 mm x 130 mm	
6735	HMI-SI-6687	Metal Jars, Instrument Boxes = 75 mm x 175 mm	
6736	HMI-SI-6688	Metal Jars, Instrument Boxes = 100 mm x 175 mm	
6737	HMI-SI-6689	Metal Jars, Instrument Boxes = 100 mm x 200 mm	
6738	HMI-SI-6690	Metal Jars, Instrument Boxes = 165 x 85 x 35 mm	
6739	HMI-SI-6691	Metal Jars, Instrument Boxes = 200 x 100 x 35 mm	
6740	HMI-SI-6692	Metal Jars, Instrument Boxes = 200 x 100 x 50 mm	
6741	HMI-SI-6693	Metal Jars, Instrument Boxes = 230 x 130 x 50 mm	
6742	HMI-SI-6694	Metal Jars, Instrument Boxes = 260 x 150 x 50 mm	
6743	HMI-SI-6695	Metal Jars, Instrument Boxes = 270 x 235 x 50 mm	
6744	HMI-SI-6696	Metal Jars, Instrument Boxes = 300 x 200 x 50 mm	
6745	HMI-SI-6697	Metal Jars, Instrument Boxes = 325 x 275 x 50 mm	

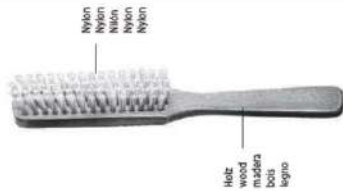

6746	HMI-SI-6698	Metal Jars, Instrument Boxes = 205 x 105 x 40 mm	
6747	HMI-SI-6699	Round Metal Boxes, Kidney Dishes = 100 mm x 60 mm	
6748	HMI-SI-6700	Round Metal Boxes, Kidney Dishes = 100 mm x 100 mm	
6749	HMI-SI-6701	Round Metal Boxes, Kidney Dishes = 125 mm x 80 mm	
6750	HMI-SI-6702	Round Metal Boxes, Kidney Dishes = 125 mm x 125 mm	
6751	HMI-SI-6703	Round Metal Boxes, Kidney Dishes = 150 mm x 150 mm	
6752	HMI-SI-6704	Round Metal Boxes, Kidney Dishes = 170 x 100 x 35 mm	
6753	HMI-SI-6705	Round Metal Boxes, Kidney Dishes = 250 x 140 x 40 mm	
6754	HMI-SI-6706	Round Metal Boxes, Kidney Dishes = 275 x 150 x 45 mm	
6755	HMI-SI-6707	Round Metal Boxes, Kidney Dishes Lid for Kidney Dishes	
6756	HMI-SI-6708	Cleaning Brushes 410 x 190 x 8/20 mm	
6757	HMI-SI-6709	Cleaning Brushes 290 x 110 x 18/33 mm	
6758	HMI-SI-6710	Cleaning Brushes 315 x 85 x 15/25 mm	

6759	HMI-SI-6711	Cleaning Brushes 415 x 70 x 8/15 mm	
6760	HMI-SI-6712	Cleaning Brushes 1000 x 180 x 16 mm	
6761	HMI-SI-6713	Cleaning Brushes 210 x 95 mm	

Waste Bucket, Waste Forceps

6762	HMI-SI-6714	Waste Bucket, Waste Forceps h = 325 mm Ø 305 mm capacity	
6763	HMI-SI-6715	Waste Bucket, Waste Forceps Martin 58 cm / 22 7/8"	
6764	HMI-SI-6716	Waste Bucket, Waste Forceps Sauerbruch 55 cm / 21 5/8"	