















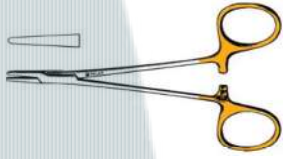
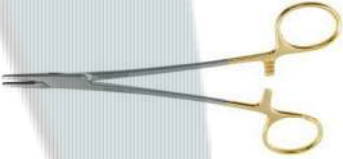
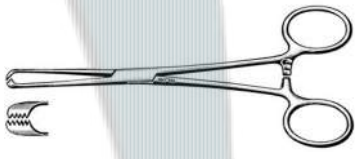

ABDOMINOPLASTY TUMMY TUCK SET			
HMI-PS-S-002			
NO	Description of Product	Qty	Images
1	Ruler, Steel, 6"	1	
2	Scalpel Handle #3	1	
3	Supercut Stevens Tenotomy Scissor, Curved, Delicate, 4-1/2"	1	
4	Mayo Dissecting Scissor, Straight, 6-3/4"	1	
5	Metzenbaum Scissor, Curved, Serrated, 5-3/4"	1	
6	Gorney-Freeman Dissecting Scissor, Curved, 9"	1	
7	TC Iris Scissor, Straight, 4-1/2"	1	
8	Halsted-Mosquito Forcep, Curved, 5"	4	
9	Lahey Traction Forceps, 6-1/4"	3	

10	Tissue Forcep, 1x2 Teeth, 6"	1	
11	TC Webster Needle Holder, Smooth, 5-1/4"	1	
12	TC Mayo-Hegar Needle Holders, Serrated, 6"	2	
13	Allis Tissue Forceps, 5x6 Teeth, 6"	2	
14	Lockwood Abdominal Demarcator	1	
15	Meyerding Retractors, Large, 2" x 3-1/2" Blade, 9-1/2"	2	
16	Adson Brown Forceps, 9x9 Teeth, Side Grasping, 4-3/4"	1	
17	Joseph Hooks, 2 Prongs, Sharp, 10mm, 6-1/2"	2	
18	Adson Tissue Forcep, 1x2 Teeth, Cross Serrated, 4-3/4"	2	

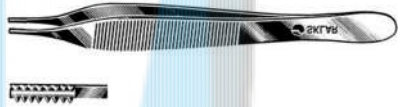
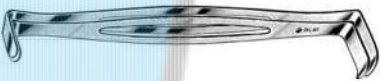
19	US Army Retractor, Set of 2, Double End, 8-1/4" "	1	
20	Yancoskie Retractor, 6 Prongs"	1	
21	Freeman Retractor, 4 Prongs, 1-1/2"	1	
26 Items, 31 PCS			